

Teknik Makina 1987 yılında otomotiv sektöründe imalat hayatına başlamıştır. Bir süre bu sektörde hizmet verdikten sonra 1994'te sektör değiştirerek, kesici takımlar imalatına adım atmıştır. Yaklaşık 5000'i aşkın ürün çeşidi ile geniş bir üretime sahiptir. Kurulduğundan bu güne kadar performans, kalite ve maliyet olarak en iyi ürünlerle hizmet vermeye devam etmektedir.

Kuruluşundan bu yana yüksek teknolojiye, yeniliklere, yeni projelere açık olup kendisini sürekli yenilemektedir.

Ürünlerinin ve hizmetinin kalitesini

arttırarak ISO9001:2008 belgesini almış; müşterilerinin var olan güvenini daha da pekiştirmiştir. Kısa ve uzun vadeli oluşturulmuş kalkınma plânlarıyla yıllık üretim adetlerini yükseltmeyi hedefleyen TEKNİK MAKİNA konusunda uzman çalışanları ile ilk günkü heyecan ve istekle çalışmalarını sürdürerek Dünya ve Türkiye pazarındaki yerini daha da sağlamlaştırarak yükselen grafiğini aynı istikrarda yürütmeye ve ülke ekonomisine katkılarını sürdürmekte kararlıdır.



Teknik Cutting tools has been established in 1987 in Turkey. Teknik Cutting Tools started to produce cutting tools in 1994. Over 5.000 kinds of tools are produced in the factory building located in the Fourth Industrial Area of Konya since 2015. Teknik Cutting Tools is a very experienced producer for a large range of a Cutting Tools: Face Mills, End Mills, Boring Bars, External Turning Holders and more. There are 40 production lines which are capable to produce in several categories at the same time.

We keep up to date with new products and when customers need special tools we do all we can to produce the tools to meet their expectations.

Production and designing teams are all educated and certified according to the ISO 9001:2008 quality standard to

serve you better.

The Company Headquarters is also located in Konya.

Konya and Istanbul branches are dedicated with marketing and sales.

Teknik Cutting Tools does international trade as cutting tools exporter with many countries all around the World and offers the highest level of quality, service and reliability, in a very short lead-time with the best price, guaranteed.





Boring Tool

Ausdrehwerkzeuge Für Die Fertigbearbeitung

Face Mill

Eckmesserkopf-Rundplattenfräse

Shoulder Milling Igelfräser

End Mill Schafffräser

Indexable Insert Drill Vollbohrer

Modular End Mill Einschraub-Fraser



Kalite için **TEKNİK Çözüm**

Technical solution for quality

Grooving Tools
Stech-Klemmhalter

Threading Tool Holders
Gevinde Bohrstange





External Turning Holders
Klemmdrehhalter

Internal Turning Holders
Bohrstangen

Tool Holders
Werkzeugaufnahmen

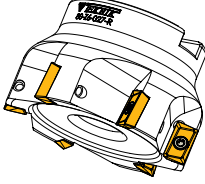
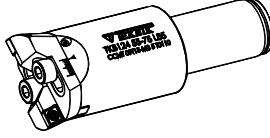
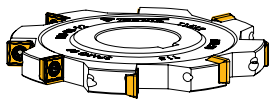
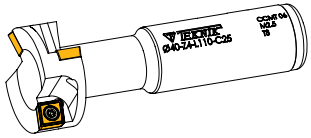
Special Tools
Spezialwerkzeuge

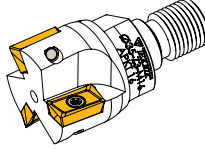
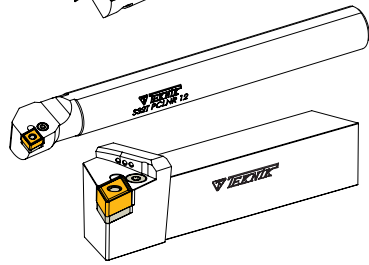

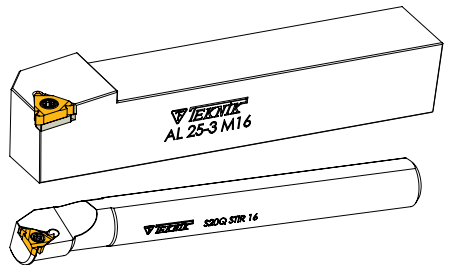
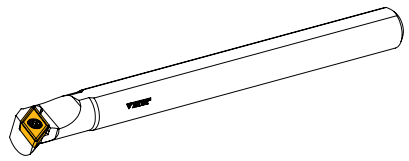
S./P.	Ürün Türü / Product Type / Produktart	
7-39	Trama Başlığı	
	Face Mill	
	Eckmessenkopf-Rundplattenfräser	
40-52	Baralar	
	Borings	
	Ausdrehwerkzeug	
53-56	Helis Freze - Disk Freze	
	Shoulder Milling - Disc Milling	
	Igelfräser - Scheibenfräsen	
58-62	T Kanal Freze	
	T-Slot Milling Cutter	
	T- Nutenfräser	
64-88	Saplı Tarama - Küre Uçlu Freze	
	End Mill - Radius Cutter - Schafffräser	
	Küre Uçlu Freze - Radius Cutter - Kugelfräser	
90-97	Modular End Mill	
	Screw Head	
	Einschraubfräser	
99-114	P - AP Sistem Kater	
	P - AP System Turning Holder	
	P - AP System Drehhalter	
116-140	D-M-C Sistem Kater	
	D-M-C System Turning Holder	
	D-M-C System Drehhalter	
142-145	Diş Katerleri	
	Threading Holders	
	D-M-C System Drehhalter	
147-172	S Sistem Kater	
	S System Turning Holder	
	S System Drehhalter	

S./P.	Ürün Türü / Product Type / Produktart
174-180	İç Çap Kater İçten Soğutmalı
	Boring Bars (Coolant) Bohrstange (mit Innenkühlung)
182-185	Karbür İç Çap Kater / Set
	Carbide Boring Bars / Set VHM Bohrstange / Set
187-188	İç Çap Kater Set
	Boring Bars Sets Bohrstangen Sets
190-202	U-DRİLL
	Indexable Insert Drills Vollbohrer
204-217	Kanal Katerler
	Grooving Holder Stech-Klemmhalter
218	Mini Kanal Kater-Dış Açma Freze
	Mini Grooving Holders - Thread Cutting Cutter Stech-Mini Klemmhalter - Gewindeschneid Fräser
219	Keski Kütüğü
	Block For Blades Grundhalter für Stechleisten
221-222	Takım Tutucuları
	Tool Holder Werkzeugaufnahmen
224-228	Yedek Parça
	Spare Parts Zubehör
229-235	Kesme Verileri - ISO Kodları
	Cutting Data- ISO Code Schnittdaten - ISO Code

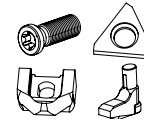
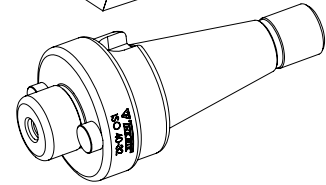
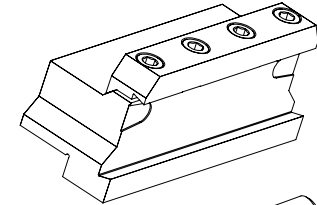
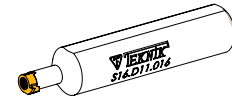
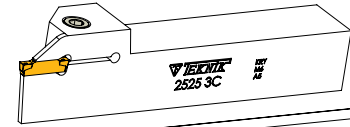
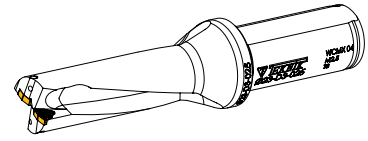
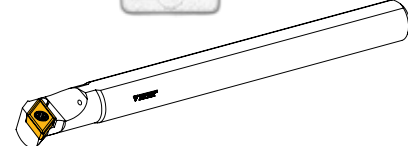
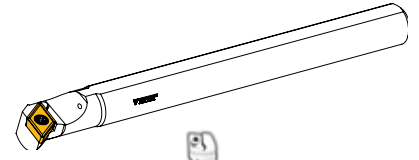



kalite için
TEKNIK çözüm

www.teknikmakinatakim.com

Technical Solution For Quality



Tarama Başlıkları

Milling Tools
Eckmesserkopf
Planmesserkopf
Rundplattenfräser

T1 45° SNKX 1206

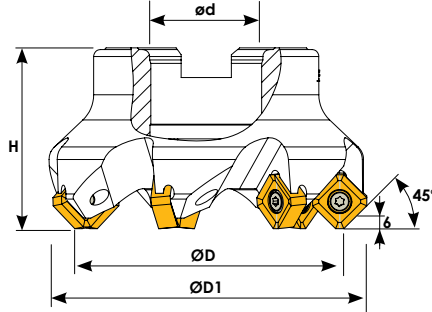

Ölçüler (mm) Dimensions(mm) Abmessungen (mm)				SNKX 1206	
L	S	a	d1		
12,7	6,35	2,36	4,5		

Sipariş Kodu Order Code Best.-Nr.	Stok/Stock/Lager	Ürün Kodu Product Code Produkt-Code	Ölçüler (mm) Dimensions(mm) Abmessungen (mm)					Kullanılan Uç Insert WSP	Sıkma Civatası Clamp Screw Torx-Schraube	Anahtar Torx Key Torx-Schlüssel
			ØD	ØD1	ød	Z	H			
T319	●	D040 D16 Z03 SN--12	40	53	16	3	45	SN-- 1206 KRLY	TC076 M4x12,5	T15
T320	●	D050 d22 Z04 SN--12	50	63	22	4	44			
T322	●	D063 d22 Z06 SN--12	63	76	22	6	44			
T325	●	D080 d27 Z07 SN--12	80	93	27	7	52			
T330	●	D100 d32 Z08 SN--12	100	113	32	8	52			
T332	●	D125 d40 Z10 SN--12	125	138	40	10	63			
T334	●	D160 d40 Z12 SN--12	160	173	40	12	63			
T335	●	D200 d60 Z14 SN--12	200	213	60	14	63			

T2 88° SNMX 1206

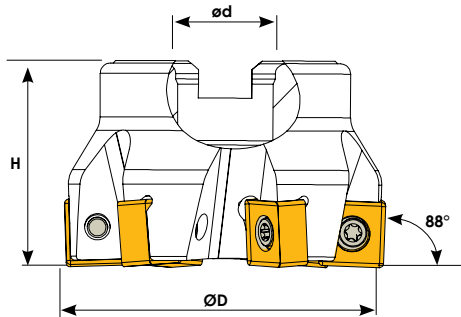

Ölçüler (mm) Dimensions(mm) Abmessungen (mm)				SNMX 1206	
L	S	r	d1		
12,7	6,35	0,80	4,5		

Sipariş Kodu Order Code Best.-Nr.	Stok/Stock/Lager	Ürün Kodu Product Code Produkt-Code	Ölçüler (mm) Dimensions(mm) Abmessungen (mm)				Kullanılan Uç Insert WSP	Sıkma Civatası Clamp Screw Torx-Schraube	Anahtar Torx Key Torx-Schlüssel
			ØD	ød	Z	H			
T344	●	D063 d22 Z06 SN--12	63	22	6	40	SNMX 1206 KRLY	TC076 M4x12,5	T15
T345	●	D080 d27 Z07 SN--12	80	27	7	50			
T346	●	D100 d32 Z08 SN--12	100	32	8	50			

KRLY ucuna uygundur. / Compatible with KRLY insert. / Kompatibel für KRLY WP

T3
90° LNMX 1006

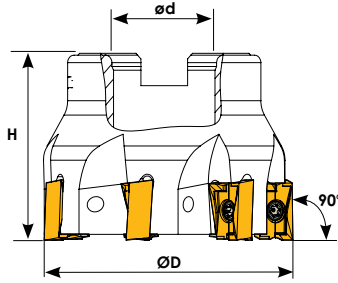

Ölçüler (mm) Dimensions(mm) Abmessungen (mm)			LNMX 1006	
L	S	A		
10	6,5	6,35		

Sipariş Kodu Order Code Best.-Nr.	Stok/Stock/Lager	Ürün Kodu Product Code Produkt-Code	Ölçüler (mm) Dimensions(mm) Abmessungen (mm)				Kullanılan Uç Insert WSP	Sıkma Cıvatası Clamp Screw Torx-Schraube	Anahtar Torx Key Torx-Schlüssel
			ØD	ød	Z	H			
T386	●	D040 d16 Z05 LN--10	40	16	5	40	LN-- 1006 KRLY	TC065 M3x7	T8
T387	●	D050 d22 Z06 LN--10	50	22	6	45			
T388	●	D063 d22 Z06 LN--10	63	22	6	45			
T389	●	D080 d27 Z07 LN--10	80	27	7	50			

T4
90° LNMX 1510

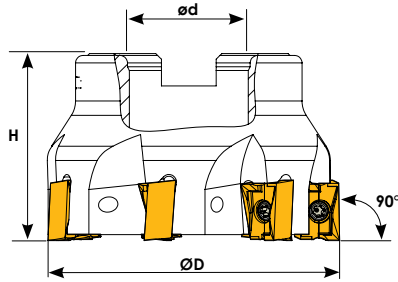

Ölçüler (mm) Dimensions(mm) Abmessungen (mm)			LNMX 1510	
L	S	A		
15	10	10		

Sipariş Kodu Order Code Best.-Nr.	Stok/Stock/Lager	Ürün Kodu Product Code Produkt-Code	Ölçüler (mm) Dimensions(mm) Abmessungen (mm)				Kullanılan Uç Insert WSP	Sıkma Cıvatası Clamp Screw Torx-Schraube	Anahtar Torx Key Torx-Schlüssel
			ØD	ød	Z	H			
T372	●	D050 d22 Z04 LN--15	50	22	4	45	LN-- 1510 KRLY	TC076 M4x12,5	T15
T374	●	D063 d22 Z06 LN--15	63	22	6	45			
T376	●	D080 d27 Z07 LN--15	80	27	7	50			
T378	●	D100 d32 Z08 LN--15	100	32	8	52			
T380	●	D125 d40 Z10 LN--15	125	40	10	63			

KRLY ucuna uygundur. / Compatible with KRLY insert. / Kompatibel für KRLY WP

T5

WNGX 0806

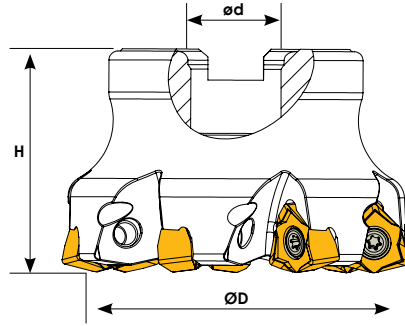

Ölçüler (mm) Dimensions(mm) Abmessungen (mm)			WNGX 0806	
l	d	s		
8,2	13	6,4		

Sipariş Kodu Order Code Best.-Nr.	Stok/Stock/Lager	Ürün Kodu Product Code Produkt-Code	Ölçüler (mm) Dimensions(mm) Abmessungen (mm)				Kullanılan Uç Insert WSP	Sıkma Civatası Clamp Screw Torx-Schraube	Anahtar Torx Key Torx-Schlüssel
			ØD	ød	Z	H			
T775	●	D063 d22 Z06 WN--08	63	22	6	40			
T776	●	D080 d27 Z06 WN--08	80	27	6	40			
T777	●	D100 d32 Z08 WN--08	100	32	8	50			
T778	●	D125 d40 Z08 WN--08	125	40	8	52			

T6

45° ONMX 0806

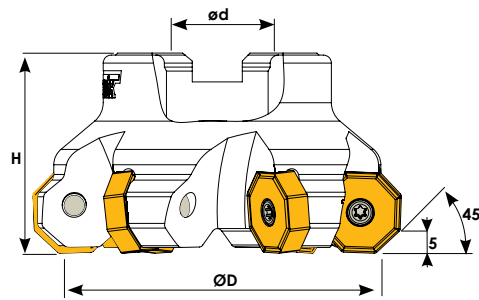

Ölçüler (mm) Dimensions(mm) Abmessungen (mm)			ONMX 0806	
l	d	s		
8,4	20,2	6		

Sipariş Kodu Order Code Best.-Nr.	Stok/Stock/Lager	Ürün Kodu Product Code Produkt-Code	Ölçüler (mm) Dimensions(mm) Abmessungen (mm)				Kullanılan Uç Insert WSP	Sıkma Civatası Clamp Screw Torx-Schraube	Anahtar Torx Key Torx-Schlüssel
			ØD	ød	Z	H			
T780	●	D063 d22 Z05 ON--08	63	22	5	40			
T782	●	D080 d27 Z06 ON--08	80	27	6	50			
T784	●	D100 d32 Z07 ON--08	100	32	7	50			
T786	●	D125 d40 Z08 ON--08	125	40	8	63			

KRLY ucuna uygundur. / Compatible with KRLY insert. / Kompatible für KRLY WP

T7
45° ONMX 0606

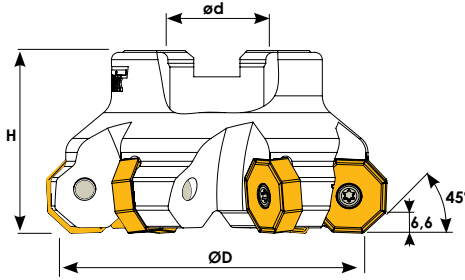

Ölçüler (mm) Dimensions (mm) Abmessungen (mm)			ONMX 0606	
I	d	S		
6,6	16	6		

Sipariş Kodu Order Code Best.-Nr.	Stok/Stock/Lager	Ürün Kodu Product Code Produkt-Code	Ölçüler (mm) Dimensions (mm) Abmessungen (mm)				Kullanılan Uç Insert WSP	Sıkma Civatası Clamp Screw Torx-Schraube	Anahtar Torx Key Torx-Schlüssel
			ØD	ød	Z	H			
T790	●	D063 d22 Z05 ON--06	63	22	5	45	ONMX 0606 KRLY	TC083 M5x12	
T791	●	D080 d27 Z06 ON--06	80	27	6	50			
T792	●	D100 d32 Z07 ON--06	100	32	7	52			

T8
WNMX 09T3

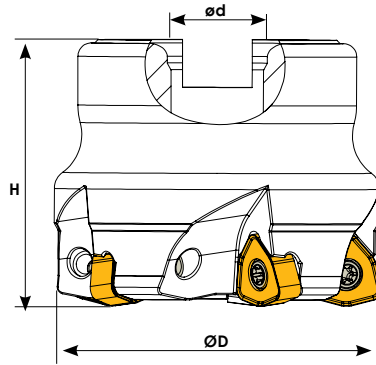

Ölçüler (mm) Dimensions (mm) Abmessungen (mm)			WNMX 09T3	
D	I	S		
9,52	6,8	3,97		

Sipariş Kodu Order Code Best.-Nr.	Stok/Stock/Lager	Ürün Kodu Product Code Produkt-Code	Ölçüler (mm) Dimensions (mm) Abmessungen (mm)				Kullanılan Uç Insert WSP	Sıkma Civatası Clamp Screw Torx-Schraube	Anahtar Torx Key Torx-Schlüssel
			ØD	ød	Z	H			
T669	●	D040 d16 Z04 WN--09	40	16	4	40	WNMX 09T3 KRLY	TC065 M3x7	T8
T770	●	D050 d22 Z05 WN--09	50	22	5	40			
T771	●	D063 d22 Z06 WN--09	63	22	6	40			

KRLY ucuna uygundur. / Compatible with KRLY insert. / Kompatible für KRLY WP

T9
XNKT 0604

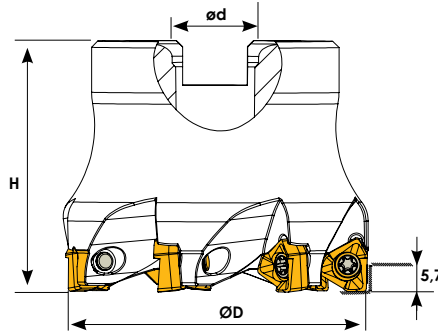

Ölçüler (mm) Dimensions(mm) Abmessungen (mm)			XNKT 0604	
d	l	s		
6,5	5,7	4		

Sipariş Kodu Order Code Best.-Nr.	Stok/Stock/Lager	Ürün Kodu Product Code Produkt-Code	Ölçüler (mm) Dimensions(mm) Abmessungen (mm)				Kullanılan Uç Insert WSP	Sıkma Civatası Clamp Screw Torx-Schraube	Anahtar Torx Key Torx-Schlüssel
			ØD	ød	Z	H			
T852	●	D032 d16 Z04 XN--06	32	16	4	40	XNKT 0604 KRLY	TC065 M3x7	T8
T853	●	D040 d16 Z06 XN--06	40	16	6	40			
T854	●	D050 d22 Z07 XN--06	50	22	7	40			
T855	●	D063 d22 Z08 XN--06	63	22	8	40			
T856	●	D080 d27 Z10 XN--06	80	27	10	50			

T10
90° XNKT 0805

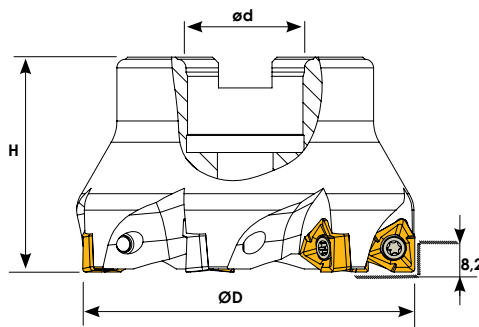

Ölçüler (mm) Dimensions(mm) Abmessungen (mm)			XNKT 0805	
d	l	s		
10	8,2	5,5		

Sipariş Kodu Order Code Best.-Nr.	Stok/Stock/Lager	Ürün Kodu Product Code Produkt-Code	Ölçüler (mm) Dimensions(mm) Abmessungen (mm)				Kullanılan Uç Insert WSP	Sıkma Civatası Clamp Screw Torx-Schraube	Anahtar Torx Key Torx-Schlüssel
			ØD	ød	Z	H			
T900	●	D040 d16 Z04 XN--08	40	16	4	45	XNKT 0805 KRLY	TC074 M4x10	T15
T902	●	D050 d22 Z05 XN--08	50	22	5	45			
T904	●	D063 d22 Z06 XN--08	63	22	6	45			
T906	●	D080 d27 Z07 XN--08	80	27	7	50			

KRLY ucuna uygundur. / Compatible with KRLY insert. / Kompatibel für KRLY WP

T11 90° APKT 1003

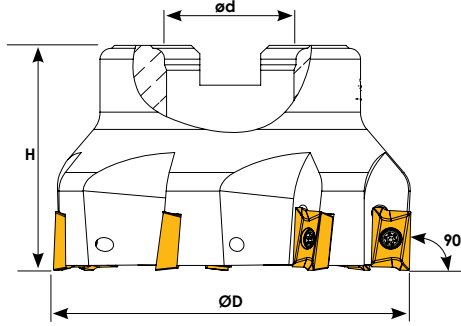

Ölçüler (mm)
Dimensions (mm)
Abmessungen (mm)

L	S
10,5	3,52

APKT 1003

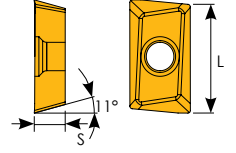

Sipariş Kodu Order Code Best.-Nr.	Stok/Stock/Lager	Ürün Kodu Product Code Produkt-Code	Ölçüler (mm) Dimensions (mm) Abmessungen (mm)				Kullanılan Uç Insert WSP	Sıkma Cıvatası Clamp Screw Torx-Schraube	Anahtar Torx Key Torx-Schlüssel
			ØD	ød	Z	H			
T176	●	D040 d16 Z05 AP--10	40	16	5	40	AP --1003 KRLY	TC060 M2,5x5,5	T8
T177	●	D050 d22 Z06 AP--10	50	22	6	40			
T178	●	D063 d22 Z07 AP--10	63	22	7	40			
T179	●	D080 d27 Z08 AP--10	80	27	8	50			

T12 90° APKT 1604

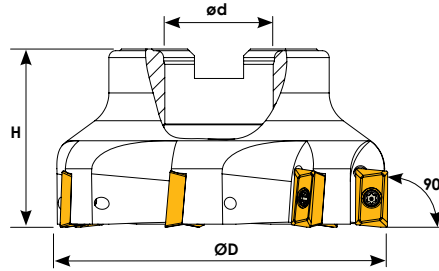

Ölçüler (mm)
Dimensions (mm)
Abmessungen (mm)

L	S
16,40	4,76

APKT 1604

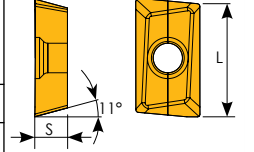

Sipariş Kodu Order Code Best.-Nr.	Stok/Stock/Lager	Ürün Kodu Product Code Produkt-Code	Ölçüler (mm) Dimensions (mm) Abmessungen (mm)				Kullanılan Uç Insert WSP	Sıkma Cıvatası Clamp Screw Torx-Schraube	Anahtar Torx Key Torx-Schlüssel
			ØD	ød	Z	H			
T180	●	D040 d16 Z03 AP--16	40	16	3	45	AP --1604 KRLY	TC074 M4x10	T15
T181	●	D040 d16 Z04 AP--16	40	16	4	45			
T182	●	D050 d22 Z04 AP--16	50	22	4	45			
T183	●	D050 d22 Z05 AP--16	50	22	5	45			
T184	●	D063 d22 Z05 AP--16	63	22	5	45			
T185	●	D063 d22 Z06 AP--16	63	22	6	45			
T186	●	D080 d27 Z06 AP--16	80	27	6	52			
T187	●	D080 d27 Z07 AP--16	80	27	7	52			
T188	●	D100 d32 Z07 AP--16	100	32	7	52			
T189	●	D100 d32 Z08 AP--16	100	32	8	52			
T190	●	D125 d40 Z09 AP--16	125	40	9	62			
T192	●	D160 d40 Z10 AP--16	160	40	10	62			
T193	●	D200 d60 Z12 AP--16	200	60	12	63			
T195	●	D300 d60 Z15 AP--16	300	60	15	62			

KRLY ucuna uygundur. / Compatible with KRLY insert. / Kompatible für KRLY WP

T13 90° APMT 11T3

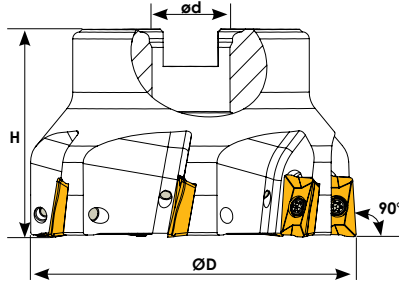

Ölçüler (mm) Dimensions (mm) Abmessungen (mm)		APMT 11T3	
L	S		
11	3,97		

Sipariş Kodu Order Code Best.-Nr.	Stok/Stock/Lager	Ürün Kodu Product Code Produkt-Code	Ölçüler (mm) Dimensions (mm) Abmessungen (mm)				Kullanılan Uç Insert WSP	Sıkma Cıvatası Clamp Screw Torx-Schraube	Anahtar Torx Key Torx-Schlüssel
			ØD	ød	Z	H			
T250	●	D040 d16 Z05 AP--11	40	16	5	40	 APMT 11T3 KRLY	 TC060 N2,5x5,5	 T8
T252	●	D050 d22 Z06 AP--11	50	22	6	40			
T254	●	D063 d22 Z07 AP--11	63	22	7	40			
T256	●	D080 d27 Z08 AP--11	80	27	8	50			
T258	●	D100 d32 Z10 AP--11	100	32	10	63			

T14 90° APMT 1604

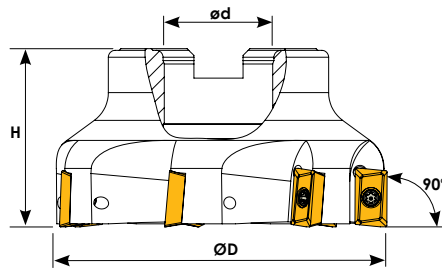

Ölçüler (mm) Dimensions (mm) Abmessungen (mm)		APMT 1604	
L	S		
16,40	4,76		

Sipariş Kodu Order Code Best.-Nr.	Stok/Stock/Lager	Ürün Kodu Product Code Produkt-Code	Ölçüler (mm) Dimensions (mm) Abmessungen (mm)				Kullanılan Uç Insert WSP	Sıkma Cıvatası Clamp Screw Torx-Schraube	Anahtar Torx Key Torx-Schlüssel
			ØD	ød	Z	H			
T241	●	D040 d16 Z04 AP--16	40	16	4	45	 APMT 1604 KRLY	 TC074 M4x10	 T15
T243	●	D050 d22 Z05 AP--16	50	22	5	45			
T245	●	D063 d22 Z06 AP--16	63	22	6	45			
T247	●	D080 d27 Z07 AP--16	80	27	7	52			
T249	●	D100 d32 Z08 AP--16	100	32	8	52			

KRLY ucuna uygundur. / Compatible with KRLY insert. / Kompatible für KRLY WP

T15

APKT 16 HAVŞA
Chamfering end Milling

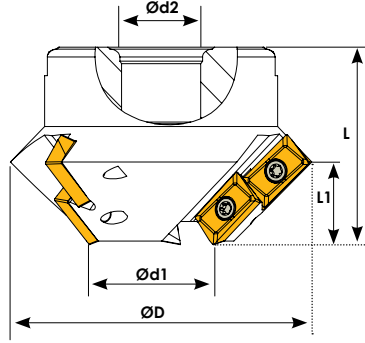

Ölçüler (mm) Dimensions (mm) Abmessungen (mm)		AP-- 1604	
L	S		
16,40	4,76		

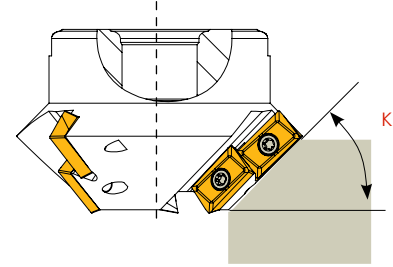
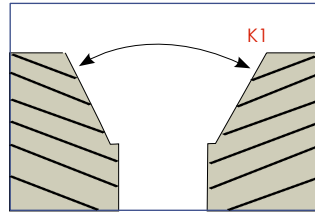

Sipariş Kodu Order Code Best.-Nr.	Stok/Stock/Lager	Ürün Kodu Product Code Produkt-Code	Ölçüler (mm) Dimensions (mm) Abmessungen (mm)									Kullanılan Uç Insert WSP	Sıkma Cıvatası Clamp Screw Torx-Schraube	Anahtar Torx Key Torx-Schlüssel
			Ød1	ØD	Z	K	K1	Ød2	Ød3	L	L1			
T455	●	35-8 6 Z06 K30° AP--16	35	86	6	30°	60°	27	60	50	15	AP-- 1604 KRLY	TC074 M4x10	T15
T456	●	35-76 Z06 K45° AP--16	35	76	6	45°	45°	27	60	50	21,5			
T457	●	35-50,5 Z06 K75° AP--16	35	50,5	6	75°	15°	22	45	60	30			
T458	●	35-94 Z06 K15° AP--16	35	94	6	15°	75°	27	60	50	8,5			

KRLY ucuna uygundur. / Compatible with KRLY insert. / Kompatible für KRLY WP

T16 F 75° APKT 1604 -1003

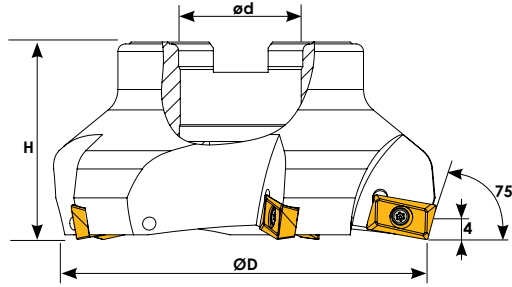

Ölçüler (mm) Dimensions(mm) Abmessungen (mm)		AP-- 1604 AP-- 1003	
L	S		
16,40	4,76		
10	3,52		

Sipariş Kodu Order Code Best.-Nr.	Stok/Stock/Lager	Ürün Kodu Product Code Produkt-Code	Ölçüler (mm) Dimensions(mm) Abmessungen (mm)				Kullanılan Uç Insert WSP	Sıkma Cıvatası Clamp Screw Torx-Schraube	Anahtar Torx Key Torx-Schlüssel
			ØD	ød	Z	H			
T308	●	D063 d22 Z04 AP--16	63	22	4	45	AP-- 1604 KRLY	TC074 M4x10	T15
T310	●	D080 d27 Z05 AP--16	80	27	5	52			
T312	●	D100 d32 Z06 AP--16	100	32	6	52			
T313	●	D125 d40 Z07 AP--16	125	40	7	62			
T452	●	D063 d22 Z06 AP--10	63	22	6	45	AP-- 1003 KRLY	TC63 M2,5x7	T8

KRLY ucuna uygundur. / Compatible with KRLY insert. / Kompatibel für KRLY WP

T17 90° XNEX 0806

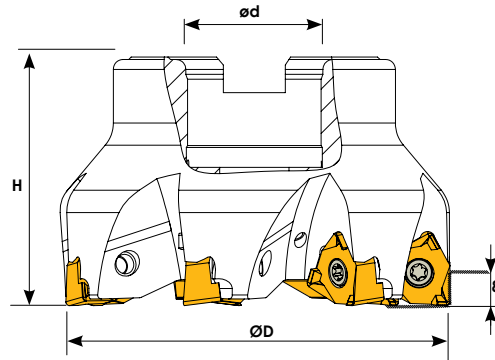

Ölçüler (mm) Dimensions(mm) Abmessungen (mm)			XNEX 0806	
d	l	s		
12,48	8	6,47		

Sipariş Kodu Order Code Best.-Nr.	Stok/Stock/Lager	Ürün Kodu Product Code Produkt-Code	Ölçüler (mm) Dimensions(mm) Abmessungen (mm)				Kullanılan Uç Insert WSP	Sıkma Cıvatası Clamp Screw Torx-Schraube	Anahtar Torx Key Torx-Schlüssel
			ØD	ød	Z	H			
T840	●	D050 d22 Z04 XN--08	50	22	4	45	XNEX 0806 SCO	TC076 M4x12,5	T15
T842	●	D063 d22 Z06 XN--08	63	22	6	45			
T844	●	D080 d27 Z07 XN--08	80	27	7	50			
T846	●	D100 d32 Z07 XN--08	100	32	7	52			
T848	●	D125 d40 Z10 XN--08	125	40	10	60			
T850	●	D160 d40 Z12 XN--08	160	40	12	63			
T851	●	D200 d60 Z14 XN--08	200	60	14	63			

SCO ucuna uygundur. / Compatible with SCO insert. / Kompatibel für SCO WP

T18 90° XOMX 1204

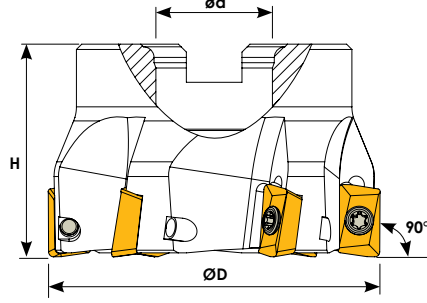

Ölçüler (mm)
Dimensions (mm)
Abmessungen (mm)

L	S
11,73-12,16	5,06

XOMX 1204

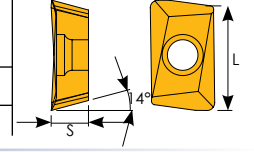

Sipariş Kodu Order Code Best.-Nr.	Stok/Stock/Lager	Ürün Kodu Product Code Produkt-Code	Ölçüler (mm) Dimensions (mm) Abmessungen (mm)				Kullanılan Uç Insert WSP	Sıkma Cıvatası Clamp Screw Torx-Schraube	Anahtar Torx Key Torx-Schlüssel
			ØD	ød	Z	H			
T510	●	D040 d16 Z04 XO--12	40	16	4	40	XOMX 1204 SCO	TC069 M3,5x8,5	T10
T512	●	D050 d22 Z05 XO--12	50	22	5	40			
T514	●	D063 d22 Z06 XO--12	63	22	6	40			
T516	●	D080 d27 Z07 XO--12	80	27	7	50			
T518	●	D100 d32 Z10 XO--12	100	32	10	52			
T519	●	D125 d40 Z12 XO--12	125	40	12	62			

T19 90° XOMX 1806

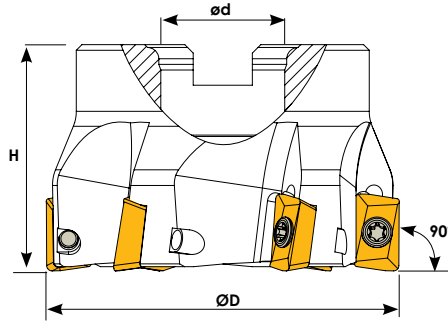

Ölçüler (mm)
Dimensions (mm)
Abmessungen (mm)

L	S
17,5	6,35

XOMX 1806

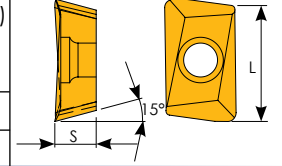

Sipariş Kodu Order Code Best.-Nr.	Stok/Stock/Lager	Ürün Kodu Product Code Produkt-Code	Ölçüler (mm) Dimensions (mm) Abmessungen (mm)				Kullanılan Uç Insert WSP	Sıkma Cıvatası Clamp Screw Torx-Schraube	Anahtar Torx Key Torx-Schlüssel
			ØD	ød	Z	H			
T520	●	D050 d22 Z05 XO--18	50	22	5	45	XOMX 1806 SCO	TC080 M4,5x11	T15
T522	●	D063 d22 Z06 XO--18	63	22	6	45			
T524	●	D080 d27 Z07 XO--18	80	27	7	50			
T525	●	D100 d32 Z08 XO--18	100	32	8	52			
T526	●	D125 d40 Z09 XO--18	125	40	9	62			
T527	●	D160 d40 Z10 XO--18	160	40	10	62			

SCO ucuna uygundur. / Compatible with SCO insert. / Kompatible für SCO WP

T20
90° R390-11T3

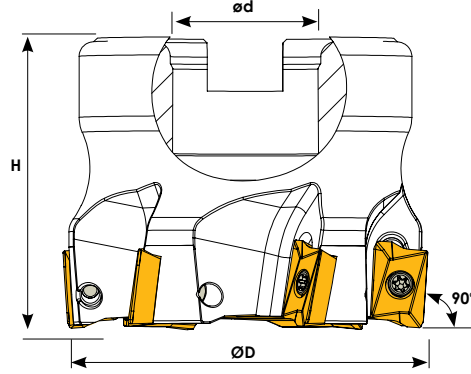

Ölçüler (mm) Dimensions(mm) Abmessungen (mm)		R390-11T3	
L	S		
11	3,18		

Sipariş Kodu Order Code Best.-Nr.	Stok/Stock/Lager	Ürün Kodu Product Code Produkt-Code	Ölçüler (mm) Dimensions(mm) Abmessungen (mm)				Kullanılan Uç Insert WSP	Sıkma Cıvatası Clamp Screw Torx-Schraube	Anahtar Torx Key Torx-Schlüssel
			ØD	ød	Z	H			
T577	●	D040 d16 Z05 R3--11	40	16	5	40	R390-11T3 SNDVK	TC063 M2,5x7	T8
T578	●	D050 d22 Z06 R3--11	50	22	6	40			
T579	●	D063 d22 Z07 R3--11	63	22	7	40			

T21
90° R390-1704

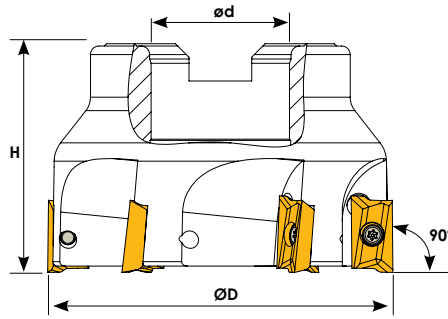

Ölçüler (mm) Dimensions(mm) Abmessungen (mm)		R390-1704	
L	S		
17	4,76		

Sipariş Kodu Order Code Best.-Nr.	Stok/Stock/Lager	Ürün Kodu Product Code Produkt-Code	Ölçüler (mm) Dimensions(mm) Abmessungen (mm)				Kullanılan Uç Insert WSP	Sıkma Cıvatası Clamp Screw Torx-Schraube	Anahtar Torx Key Torx-Schlüssel
			ØD	ød	Z	H			
T402	●	D040 d16 Z04 R3--17	40	16	4	45	R390-1704 SNDVK	TC067-1 M3,5x8,5	T15
T404	●	D050 d22 Z05 R3--17	50	22	5	45			
T408	●	D063 d22 Z06 R3--17	63	22	6	45			
T411	●	D080 d27 Z07 R3--17	80	27	7	52			
T412	●	D100 d32 Z08 R3--17	100	32	8	52			
T414	●	D125 d40 Z09 R3--17	125	40	9	62			
T416	●	D160 d40 Z10 R3--17	160	40	10	62			

SNDVK ucuna uygundur. / Compatible with SNDVK insert. / Kompatibel für SNDVK WP

T22
90° R390-1806

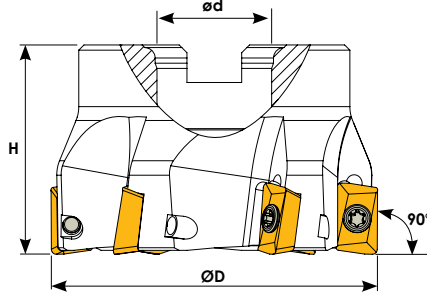

Ölçüler (mm) Dimensions(mm) Abmessungen (mm)		R390-1806	
L	S		
18	6,33		

Sipariş Kodu Order Code Best.-Nr.	Stok/Stock/Lager	Ürün Kodu Product Code Produkt-Code	Ölçüler (mm) Dimensions(mm) Abmessungen (mm)				Kullanılan Uç Insert WSP	Sıkma Civatası Clamp Screw Torx-Schraube	Anahtar Torx Key Torx-Schlüssel
			ØD	ød	Z	H			
T423	●	D050 d22 Z04 R3--18	50	22	4	45	R390-1806 SNDVK	TC074 M4x10	T15
T424	●	D063 d22 Z05 R3--18	63	22	5	45			
T426	●	D080 d27 Z06 R3--18	80	27	6	52			
T428	●	D100 d32 Z07 R3--18	100	32	7	52			
T430	●	D125 d40 Z08 R3--18	125	40	8	62			
T432	●	D160 d40 Z10 R3--18	160	40	10	62			

T23
RCKT 1204

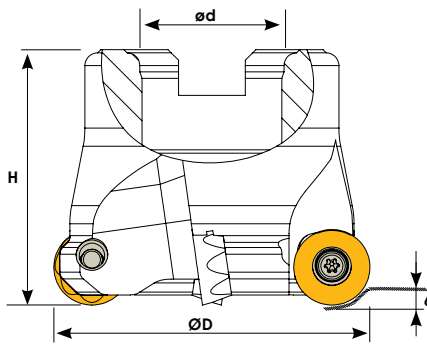

Ölçüler (mm) Dimensions(mm) Abmessungen (mm)		RCKT 1204	
D	S		
12	4,76		

Sipariş Kodu Order Code Best.-Nr.	Stok/Stock/Lager	Ürün Kodu Product Code Produkt-Code	Ölçüler (mm) Dimensions(mm) Abmessungen (mm)				Kullanılan Uç Insert WSP	Sıkma Civatası Clamp Screw Torx-Schraube	Anahtar Torx Key Torx-Schlüssel
			ØD	ød	Z	H			
T460	●	D050 d22 Z04 RC--12	50	22	4	40	RCKT 1204 SNDVK	TC067 M3,5x9	T15
T462	●	D063 d22 Z05 RC--12	63	22	5	40			
T464	●	D080 d27 Z06 RC--12	80	27	6	50			
T466	●	D100 d32 Z07 RC--12	100	32	7	52			

SNDVK ucuna uygundur. / Compatible with SNDVK insert. / Kompatibel für SNDVK WP

T24
90° ADMT 1204

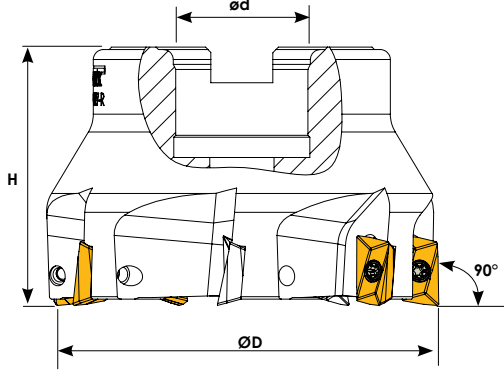

Ölçüler (mm) Dimensions(mm) Abmessungen (mm)		ADMT 1204	
L	S		
13,6	4,76		

Sipariş Kodu Order Code Best.-Nr.	Stok/Stock/Lager	Ürün Kodu Product Code Produkt-Code	Ölçüler (mm) Dimensions(mm) Abmessungen (mm)				Kullanılan Uç Insert WSP	Sıkma Cıvatası Clamp Screw Torx-Schraube	Anahtar Torx Key Torx-Schlüssel
			ØD	ød	Z	H			
T214	●	D040 d16 Z04 AD--12	40	16	4	45	 ADMT 1204 WLTR	 TC065 M3x7	 T8
T215	●	D050 d22 Z05 AD--12	50	22	5	45			
T217	●	D063 d22 Z06 AD--12	63	22	6	45			
T219	●	D080 d27 Z07 AD--12	80	27	7	52			
T220	●	D100 d32 Z08 AD--12	100	32	8	52			

T25
90° ADMT 1606

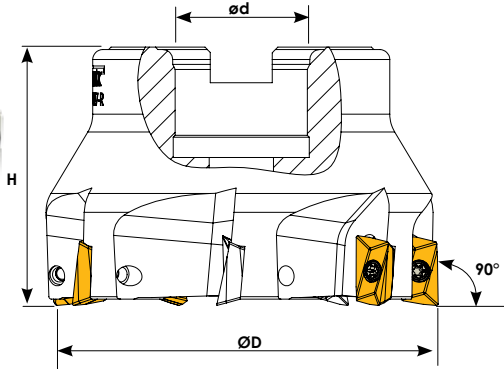

Ölçüler (mm) Dimensions(mm) Abmessungen (mm)		ADMT 1606	
L	S		
17,5	6,15		

Sipariş Kodu Order Code Best.-Nr.	Stok/Stock/Lager	Ürün Kodu Product Code Produkt-Code	Ölçüler (mm) Dimensions(mm) Abmessungen (mm)				Kullanılan Uç Insert WSP	Sıkma Cıvatası Clamp Screw Torx-Schraube	Anahtar Torx Key Torx-Schlüssel
			ØD	ød	Z	H			
T351	●	D040 d16 Z04 AD--16	40	16	4	45	 ADMT 1606 WLTR	 TC079 M4x10	 T15
T352	●	D050 d22 Z05 AD--16	50	22	5	45			
T354	●	D063 d22 Z06 AD--16	63	22	6	45			
T356	●	D080 d27 Z07 AD--16	80	27	7	52			

WLTR ucuna uygundur. / Compatible with WLTR insert. / Kompatible für WLTR WP

T26
90° LNGX 1307

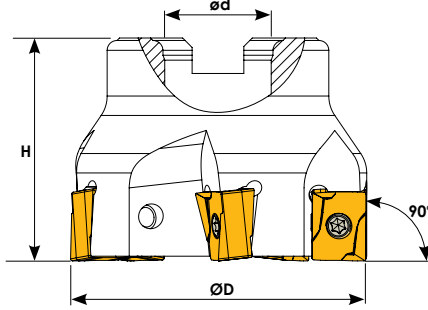

Ölçüler (mm)
Dimensions(mm)
Abmessungen (mm)

A	L	S
11	14	7,74

LNGX 1307

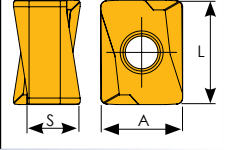

Sipariş Kodu Order Code Best.-Nr.	Stok/Stock/Lager	Ürün Kodu Product Code Produkt-Code	Ölçüler (mm) Dimensions(mm) Abmessungen (mm)				Kullanılan Uç Insert WSP	Sıkma Cıvatası Clamp Screw Torx-Schraube	Anahtar Torx Key Torx-Schlüssel
			ØD	ød	Z	H			
T488	●	D040 d16 Z03 LN--13	40	16	3	45	LNGX 1307 WLTR	TC079 M4x10	T15
T490	●	D050 d22 Z04 LN--13	50	22	4	45			
T492	●	D063 d22 Z06 LN--13	63	22	6	45			
T493	●	D080 d27 Z07 LN--13	80	27	7	50			
T494	●	D100 d32 Z07 LN--13	100	32	7	50			
T495	●	D125 d40 Z08 LN--13	125	40	8	63			

T27
43° ODHT 0605

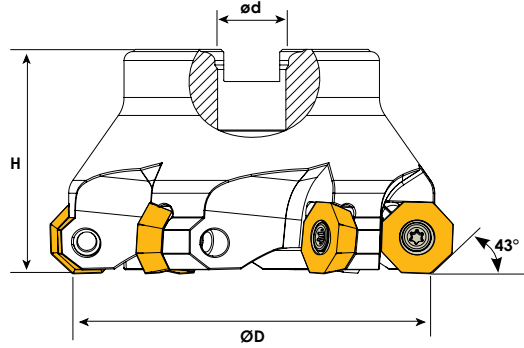

Ölçüler (mm)
Dimensions(mm)
Abmessungen (mm)

l	d	S
x	x	x

ODHT 0605

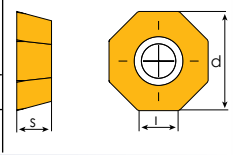

Sipariş Kodu Order Code Best.-Nr.	Stok/Stock/Lager	Ürün Kodu Product Code Produkt-Code	Ölçüler (mm) Dimensions(mm) Abmessungen (mm)				Kullanılan Uç Insert WSP	Sıkma Cıvatası Clamp Screw Torx-Schraube	Anahtar Torx Key Torx-Schlüssel
			ØD	ød	Z	H			
T210	●	D063 d22 Z05 OD--06	63	22	5	40	ODHT 0605 WLTR	TC085 M5x12	T20
T211	●	D080 d27 Z06 OD--06	80	27	6	50			
T212	●	D100 d32 Z07 OD--06	100	32	7	52			
T213	●	D125 d40 Z08 OD--06	125	40	8	62			

WLTR ucuna uygundur. / Compatible with WLTR insert. / Kompatibel für WLTR WP

T28
90° BDMT 11T3

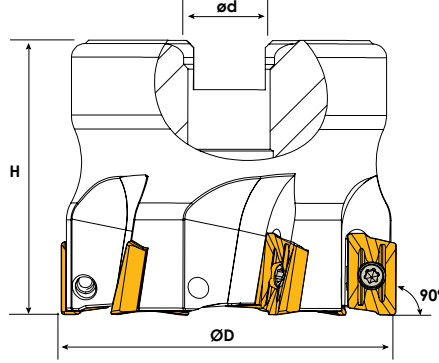

Ölçüler (mm) Dimensions(mm) Abmessungen (mm)		BDMT 11T3	
L	S		
11	3,80		

Sipariş Kodu Order Code Best.-Nr.	Stok/Stock/Lager	Ürün Kodu Product Code Produkt-Code	Ölçüler (mm) Dimensions(mm) Abmessungen (mm)				Kullanılan Uç Insert WSP	Sıkma Cıvatası Clamp Screw Torx-Schraube	Anahtar Torx Key Torx-Schlüssel
			ØD	ød	Z	H			
T533	●	D040 d16 Z05 BD--11	40	16	5	40	 BDMT 11T3 KYCRA	 TC060 M2,5x5,5	 T8
T534	●	D050 d22 Z06 BD--11	50	22	6	40			
T535	●	D063 d22 Z07 BD--11	63	22	7	40			

T29
90° BDMT 1704

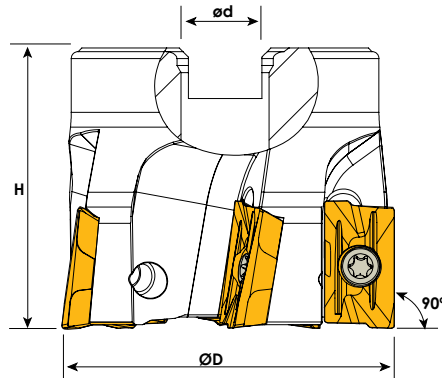

Ölçüler (mm) Dimensions(mm) Abmessungen (mm)		BDMT 1704	
L	S		
17	4,90		

Sipariş Kodu Order Code Best.-Nr.	Stok/Stock/Lager	Ürün Kodu Product Code Produkt-Code	Ölçüler (mm) Dimensions(mm) Abmessungen (mm)				Kullanılan Uç Insert WSP	Sıkma Cıvatası Clamp Screw Torx-Schraube	Anahtar Torx Key Torx-Schlüssel
			ØD	ød	Z	H			
T537	●	D040 d16 Z04 BD--17	40	16	4	40	 BDMT 1704 KYCRA	 TC074 M4x10	 T15
T538	●	D050 d22 Z05 BD--17	50	22	5	40			
T539	●	D063 d22 Z06 BD--17	63	22	6	40			
T540	●	D080 d27 Z07 BD--17	80	27	7	50			

KYCRA ucuna uygundur. / Compatible with KYCRA insert. / Kompatibel für KYCRA WP

T30
90° 3PKT 1505

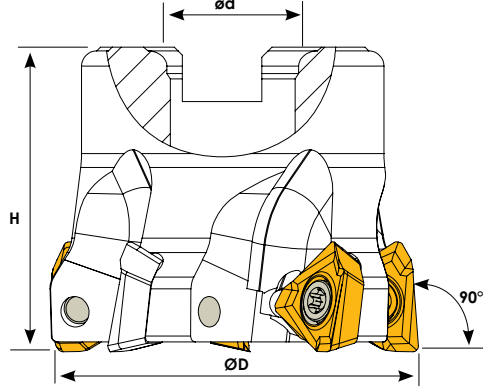

Ölçüler (mm) Dimensions (mm) Abmessungen (mm)			3PKT 1505	
d	l	s		
10,7	11	5		

Sipariş Kodu Order Code Best.-Nr.	Stok/Stock/Lager	Ürün Kodu Product Code Produkt-Code	Ölçüler (mm) Dimensions (mm) Abmessungen (mm)				Kullanılan Uç Insert WSP	Sıkma Civatası Clamp Screw Torx-Schraube	Anahtar Torx Key Torx-Schlüssel
			ØD	ød	Z	H			
T398	●	D050 d22 Z05-3P--15	50	22	5	40	3PKT 1505 TGTC	TC074 M4x10	T15
T399	●	D063 d22 Z06-3P--15	63	22	6	40			
T400	●	D080 d27 Z07-3P--15	80	27	7	50			

T31
55° HNHX 1006

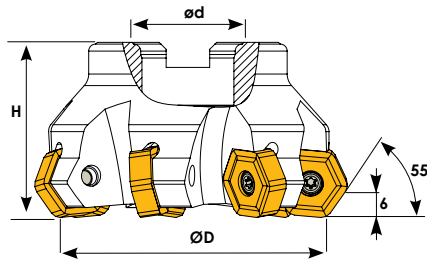

Ölçüler (mm) Dimensions (mm) Abmessungen (mm)			HNHX 1006	
l	d	s		
10	19,05	6,35		

Sipariş Kodu Order Code Best.-Nr.	Stok/Stock/Lager	Ürün Kodu Product Code Produkt-Code	Ölçüler (mm) Dimensions (mm) Abmessungen (mm)				Kullanılan Uç Insert WSP	Sıkma Civatası Clamp Screw Torx-Schraube	Anahtar Torx Key Torx-Schlüssel
			ØD	ød	Z	H			
T470	●	D063 d22 Z05 HN--10	63	22	5	50	HNHX 1006 TGTC	TC083 M5x12	T20
T472	●	D080 d27 Z07 HN--10	80	27	7	50			
T474	●	D100 d32 Z09 HN--10	100	32	9	62			
T476	●	D125 d40 Z10 HN--10	125	40	10	62			
T478	●	D160 d40 Z12 HN--10	160	40	12	62			

TGTCucuna uygundur. / Compatible with TGTCinsert. / Kompatible für TGTCWP

T32
100° BLMP 0603

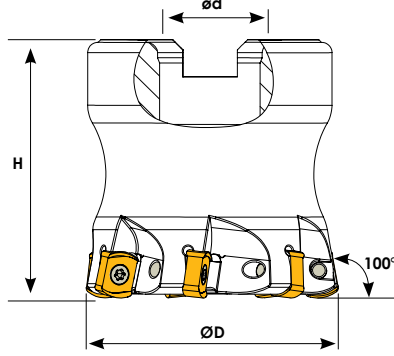

Ölçüler (mm) Dimensions (mm) Abmessungen (mm)			BLMP 0603	
d	l	s		
6,39	9	3,73		

Sipariş Kodu Order Code Best.-Nr.	Stok/Stock/Lager	Ürün Kodu Product Code Produkt-Code	Ölçüler (mm) Dimensions (mm) Abmessungen (mm)				Kullanılan Uç Insert WSP	Sıkma Cıvatası Clamp Screw Torx-Schraube	Anahtar Torx Key Torx-Schlüssel
			ØD	ød	Z	H			
T480	●	D040 d16 Z06 BL--06	40	16	6	45	BLMP 0603 TGTC	TC064 M3x6,5	T8
T481	●	D050 d22 Z07 BL--06	50	22	7	50			
T482	●	D052 d22 Z07 BL--06	52	22	7	50			

T33
100° BLMP 0904

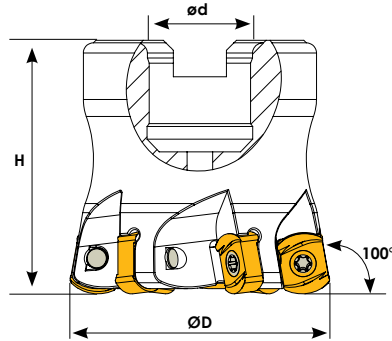

Ölçüler (mm) Dimensions (mm) Abmessungen (mm)			BLMP 0904	
d	l	s		
9,18	11,9	4,8		

Sipariş Kodu Order Code Best.-Nr.	Stok/Stock/Lager	Ürün Kodu Product Code Produkt-Code	Ölçüler (mm) Dimensions (mm) Abmessungen (mm)				Kullanılan Uç Insert WSP	Sıkma Cıvatası Clamp Screw Torx-Schraube	Anahtar Torx Key Torx-Schlüssel
			ØD	ød	Z	H			
T485	●	D040 d16 Z05 BL--09	40	16	5	40	BLMP 0904 TGTC	TC097 M4x10	T15
T486	●	D052 d22 Z06 BL--09	52	22	6	40			
T487	●	D063 d22 Z07 BL--09	63	22	7	40			

TGTC ucuna uygundur. / Compatible with TGTC insert. / Kompatibel für TGTC WP

T34
90° APKT 1705

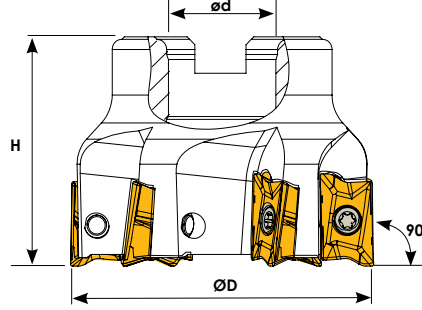

Ölçüler (mm) Dimensions (mm) Abmessungen (mm)		AP-- 1705	
L	S	L	S
17	5,56		

Sipariş Kodu Order Code Best.-Nr.	Stok/Stock/Lager	Ürün Kodu Product Code Produkt-Code	Ölçüler (mm) Dimensions (mm) Abmessungen (mm)				Kullanılan Uç Insert WSP	Sıkma Cıvatası Clamp Screw Torx-Schraube	Anahtar Torx Key Torx-Schlüssel
			ØD	ød	Z	H			
T550	●	D040 d16 Z04 AP--17	40	16	4	45	AP-- 1705 TGTC	TC096 M4x10	T15
T552	●	D050 d22 Z05 AP--17	50	22	5	45			
T554	●	D063 d22 Z06 AP--17	63	22	6	45			
T556	●	D080 d27 Z07 AP--17	80	27	7	50			
T558	●	D100 d32 Z08 AP--17	100	32	8	52			

T35
90° SPMG 0904

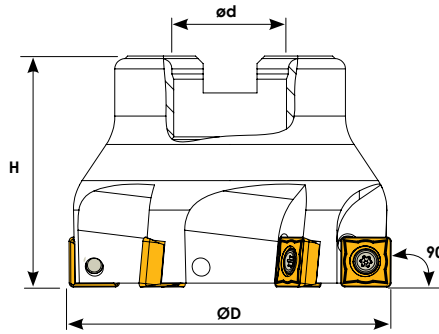

Ölçüler (mm) Dimensions (mm) Abmessungen (mm)		SPMG 0904	
L	S	L	S
9,8	4,30		

Sipariş Kodu Order Code Best.-Nr.	Stok/Stock/Lager	Ürün Kodu Product Code Produkt-Code	Ölçüler (mm) Dimensions (mm) Abmessungen (mm)				Kullanılan Uç Insert WSP	Sıkma Cıvatası Clamp Screw Torx-Schraube	Anahtar Torx Key Torx-Schlüssel
			ØD	ød	Z	H			
T338	●	D050 d22 Z05 SP--09	50	22	5	45	SPMG 0904 TGTC	TC067 M3,5x9	T15
T340	●	D063 d22 Z06 SP--09	63	22	6	45			
T342	●	D080 d27 Z07 SP--09	80	27	7	52			

TGTC ucuna uygundur. / Compatible with TGTCinsert. / Kompatible für TGTC WP

T36
90° LNMT 0804

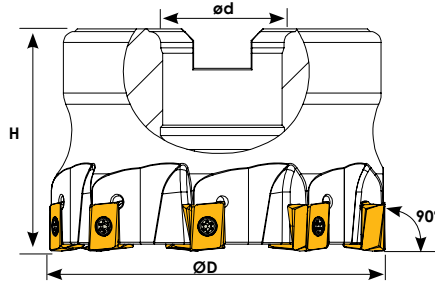

Ölçüler (mm) Dimensions (mm) Abmessungen (mm)			LNMT 0804	
L	S	A		

Sipariş Kodu Order Code Best.-Nr.	Stok/Stock/Lager	Ürün Kodu Product Code Produkt-Code	Ölçüler (mm) Dimensions (mm) Abmessungen (mm)				Kullanılan Uç Insert WSP	Sıkma Civatası Clamp Screw Torx-Schraube	Anahtar Torx Key Torx-Schlüssel
			ØD	ød	Z	H			
T222	●	D040 d16 Z06 LN--08	40	16	6	40	LNMT 0804 ISCR	TC063 M2,5x7	T8
T223	●	D050 d22 Z07 LN--08	50	22	7	40			
T224	●	D063 d22 Z09 LN--08	63	22	9	40			
T225	●	D080 d27 Z10 LN--08	80	27	10	50			

T37
90° LNMT 1306

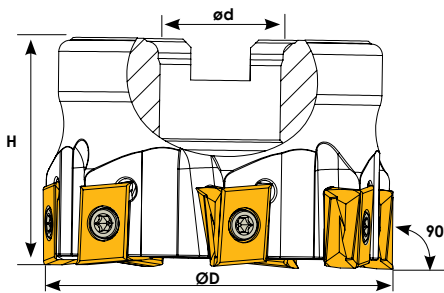

Ölçüler (mm) Dimensions (mm) Abmessungen (mm)			LNMT 1306	
L	S	A		

Sipariş Kodu Order Code Best.-Nr.	Stok/Stock/Lager	Ürün Kodu Product Code Produkt-Code	Ölçüler (mm) Dimensions (mm) Abmessungen (mm)				Kullanılan Uç Insert WSP	Sıkma Civatası Clamp Screw Torx-Schraube	Anahtar Torx Key Torx-Schlüssel
			ØD	ød	Z	H			
T228	●	D050 d22 Z05 LN--13	50	22	5	40	LNMT 1306 ISCR	TC 074 M4X10	T15
T229	●	D063 d22 Z07 LN--13	63	22	7	40			
T230	●	D080 d27 Z09 LN--13	80	27	9	50			
T231	●	D100 d32 Z10 LN--13	100	32	10	50			
T232	●	D125 d40 Z12 LN--13	125	40	12	63			

ISCR ucuna uygundur. / Compatible with SNDVK insert. / Kompatible für SNDVK WP

T38
90° ANKX 1205

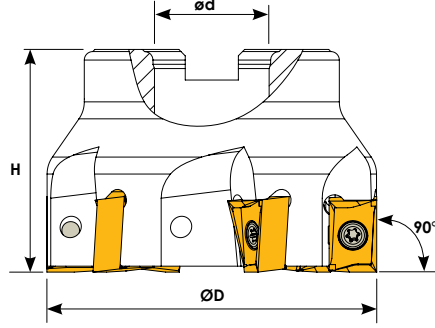

Ölçüler (mm) Dimensions (mm) Abmessungen (mm)			ANKX 1205	
L	S	A		
13,7	9,15	9,7	A	S

Sipariş Kodu Order Code Best.-Nr.	Stok/Stock/Lager	Ürün Kodu Product Code Produkt-Code	Ölçüler (mm) Dimensions (mm) Abmessungen (mm)				Kullanılan Uç Insert WSP	Sıkma Cıvatası Clamp Screw Torx-Schraube	Anahtar Torx Key Torx-Schlüssel
			ØD	ød	Z	H			
T571	●	D040 d16 Z04 AN--12	40	16	4	40	ANKX 1205 ISCR	TC097 M4x10	T15
T572	●	D050 d22 Z05 AN--12	50	22	5	45			
T574	●	D063 d22 Z06 AN--12	63	22	6	45			
T576	●	D080 d27 Z07 AN--12	80	27	7	50			

T39
90° ANKX 1710

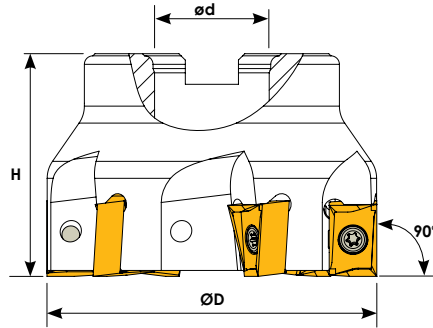

Ölçüler (mm) Dimensions (mm) Abmessungen (mm)			ANKX 1710	
L	S	A		
16,7	10,4	11,2	A	S



Sipariş Kodu Order Code Best.-Nr.	Stok/Stock/Lager	Ürün Kodu Product Code Produkt-Code	Ölçüler (mm) Dimensions (mm) Abmessungen (mm)				Kullanılan Uç Insert WSP	Sıkma Cıvatası Clamp Screw Torx-Schraube	Anahtar Torx Key Torx-Schlüssel
			ØD	ød	Z	H			
T440	●	D040 d16 Z03 AN--17	40	16	3	45	ANKX 1710 ISCR	TC085 M5x12	T20
T442	●	D050 d22 Z04 AN--17	50	22	4	45			
T444	●	D063 d22 Z05 AN--17	63	22	5	45			
T446	●	D080 d27 Z06 AN--17	80	27	6	52			
T448	●	D100 d32 Z07 AN--17	100	32	7	52			
T450	●	D125 d40 Z08 AN--17	125	40	8	63			

ISCR ucuna uygundur. / Compatible with ISCR insert. / Kompatible für ISCR WP

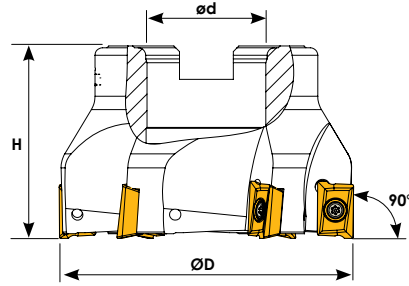
T40 90° ADKT 1505

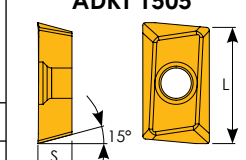



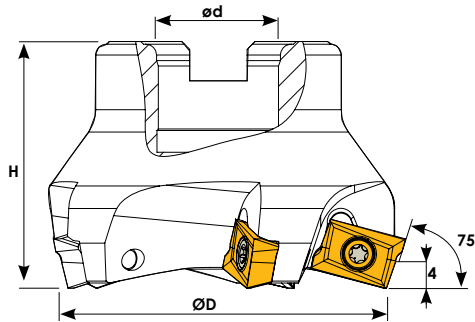

Ölçüler (mm) Dimensions (mm) Abmessungen (mm)		ADKT 1505	
L	S		
15,7	5,63		

Sipariş Kodu Order Code Best.-Nr.	Stok/Stock/Lager	Ürün Kodu Product Code Produkt-Code	Ölçüler (mm) Dimensions (mm) Abmessungen (mm)				Kullanılan Uç Insert WSP	Sıkma Cıvatası Clamp Screw Torx-Schraube	Anahtar Torx Key Torx-Schlüssel
			ØD	ød	Z	H			
T200	●	D040 d16 Z04 AD--15	40	16	4	45	 ADKT 1505 ISCR	 TC074 M4x11	 T15
T202	●	D050 d22 Z05 AD--15	50	22	5	45			
T204	●	D063 d22 Z06 AD--15	63	22	6	45			
T206	●	D080 d27 Z07 AD--15	80	27	7	52			
T207	●	D100 d32 Z08 AD--15	100	32	8	52			
T208	●	D125 d40 Z09 AD--15	125	40	9	62			

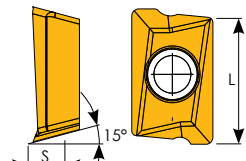
T41 F 75° ADKT 1505



Ölçüler (mm) Dimensions (mm) Abmessungen (mm)		ADKT 1505	
L	S		
15,70	5,63		

Sipariş Kodu Order Code Best.-Nr.	Stok/Stock/Lager	Ürün Kodu Product Code Produkt-Code	Ölçüler (mm) Dimensions (mm) Abmessungen (mm)				Kullanılan Uç Insert WSP	Sıkma Cıvatası Clamp Screw Torx-Schraube	Anahtar Torx Key Torx-Schlüssel
			ØD	ød	Z	H			
T530	●	D063 d22 Z05 AD--15	63	22	5	45	 ADKT 1505 ISCR	 TC074 M4x10	 T15
T532	●	D080 d27 Z06 AD--15	80	27	6	50			

ISCR ucuna uygundur. / Compatible with ISCR insert. / Kompatible für ISCR WP

T42 45° ONMU 0505

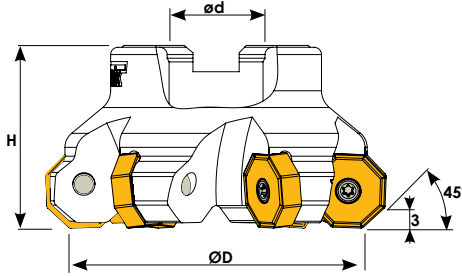

Ölçüler (mm) Dimensions (mm) Abmessungen (mm)			ONMU 0505	
l	d	S		
5	13	5,20		

Sipariş Kodu Order Code Best.-Nr.	Stok/Stock/Lager	Ürün Kodu Product Code Produkt-Code	Ölçüler (mm) Dimensions (mm) Abmessungen (mm)				Kullanılan Uç Insert WSP	Sıkma Cıvatası Clamp Screw Torx-Schraube	Anahtar Torx Key Torx-Schlüssel
			ØD	ød	Z	H			
T794	●	D063 d22 Z06 ON--05	63	22	6	45	ONMU 0505 ISCR	TC085 M5x12	T20
T796	●	D080 d27 Z07 ON--05	80	27	7	50			
T798	●	D100 d32 Z08 ON--05	100	32	8	52			
T800	●	D125 d40 Z10 ON--05	125	40	10	62			
T801	●	D160 d40 Z12 ON--05	160	40	12	62			

ISCR ucuna uygundur. / Compatible with ISCR insert. / Kompatible für ISCR WP

43° OFCR 0704

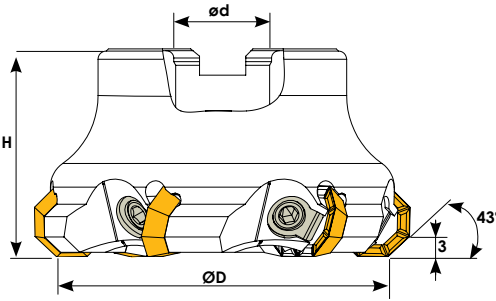

Ölçüler (mm) Dimensions (mm) Abmessungen (mm)			OFCR 0704	
l	L	S		
7	18	4,97		

Sipariş Kodu Order Code Best.-Nr.	Stok/Stock/Lager	Ürün Kodu Product Code Produkt-Code	Ölçüler (mm) Dimensions (mm) Abmessungen (mm)				Kullanılan Uç Insert WSP	Baskı Kepi Clamp Spann pratze	Sıkma Cıvatası Clamp Screw Inbuss-Schraube	Anahtar Allen Key Inbusschlüssel
			ØD	ød	Z	H				
T260	●	D050 d22 Z04 OF--07	50	22	4	45	OFCR 0704 ISO	BK300	TC300 M8x18	4 Allen
T262	●	D063 d22 Z04 OF--07	63	22	4	45				
T264	●	D080 d27 Z06 OF--07	80	27	6	50				
T266	●	D100 d32 Z08 OF--07	100	32	8	50				
T268	●	D125 d40 Z09 OF--07	125	40	9	62				
T269	●	D160 d40 Z12 OF--07	160	40	12	62				

OFCR 0704 ISO'dur. / 43° OFCR 0704 is ISO. / Kompatible für ISO WP

90° VCGT 16- DCMT 11T3

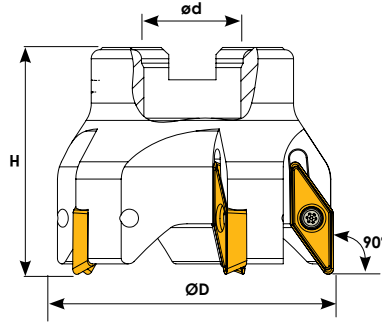

Ölçüler (mm) Dimensions(mm) Abmessungen (mm)		VCGT 16 -DCMT 11	
L	S		
16,6	4,76		
11	3,97		

Sipariş Kodu Order Code Best.-Nr.	Stok/Stock/Lager	Ürün Kodu Product Code Produkt-Code	Ölçüler (mm) Dimensions(mm) Abmessungen (mm)				Kullanılan Uç Insert WSP	Sıkma Civatası Clamp Screw Torx-Schraube	Anahtar Torx Key Torx-Schlüssel
			ØD	ød	Z	H			
T498	●	D040 d16 Z03 VC--16	40	16	3	52	VCGT 16 ISO	TC074 M4x10	T15
T500	●	D050 d22 Z04 VC--16	50	22	4	52			
T502	●	D063 d22 Z05 VC--16	63	22	5	52			
T504	●	D080 d27 Z06 VC--16	80	27	6	52			
T506	●	D063 d22 Z05 DC--11	63	22	5	52	DCMT 11T3 ISO	TC067 M3,5x9	

VCGT 16 ISO'dur. / VCGT 16 is ISO. / Kompatible für ISO WP

45° SDHT 1204

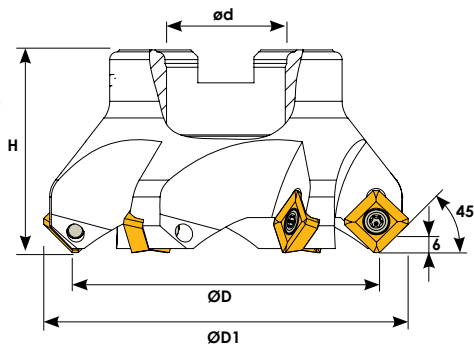
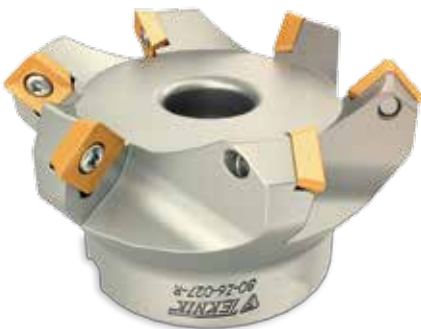

Ölçüler (mm) Dimensions(mm) Abmessungen (mm)		SDHT 1204	
L	S		
12,7	4,76		

Sipariş Kodu Order Code Best.-Nr.	Stok/Stock/Lager	Ürün Kodu Product Code Produkt-Code	Ölçüler (mm) Dimensions(mm) Abmessungen (mm)				Kullanılan Uç Insert WSP	Sıkma Civatası Clamp Screw Torx-Schraube	Anahtar Torx Key Torx-Schlüssel	
			ØD	ØD1	ød	Z				H
T300	●	D063 d22 Z05 SD--12	63	77	22	5	45	SDHT 1204 ISO	TC080 M4,5x11	T15
T302	●	D080 d27 Z06 SD--12	80	94	27	6	52			
T304	●	D100 d32 Z07 SD--12	100	114	32	7	62			
T305	●	D125 d40 Z08 SD--12	125	139	40	8	62			

45° SDHT 1204 ISO'dur. / 45° SDHT 1204 is ISO. / Kompatible für ISO WP

T43 SNEU 1206

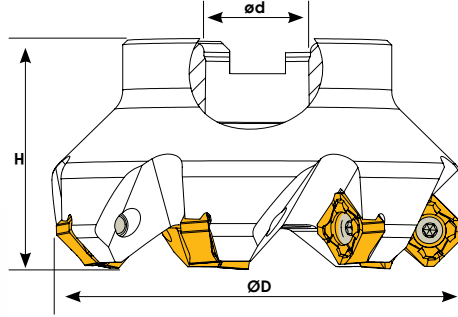

Ölçüler (mm) Dimensions (mm) Abmessungen (mm)				SNEU 1206	
L	S	a	d1		
12,7	6,35	2,2	6	L	S

Sipariş Kodu Order Code Best.-Nr.	Stok/Stock/Lager	Ürün Kodu Product Code Produkt-Code	Ölçüler (mm) Dimensions (mm) Abmessungen (mm)				Kullanılan Uç Insert WSP	Sıkma Civatası Clamp Screw Torx-Schraube	Anahtar Torx Key Torx-Schlüssel
			ØD	ød	Z	H			
T164	●	D050 D22 Z05 SN--12	50	22	5	40			
T165	●	D063 d22 Z06 SN--12	63	22	6	40			
T166	●	D080 d27 Z07 SN--12	80	27	7	50			
T167	●	D100 d32 Z08 SN--12	100	32	8	50			
T168	●	D125 d40 Z10 SN--12	125	40	10	63			

T44 90° ANKX 1607

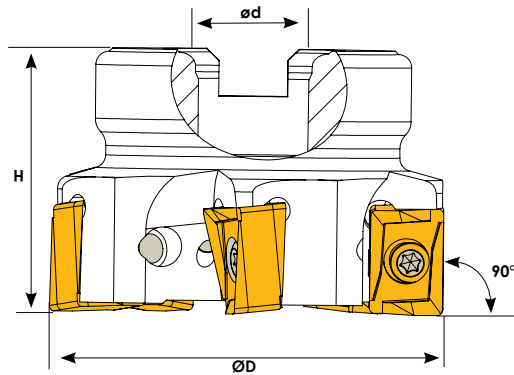

Ölçüler (mm) Dimensions (mm) Abmessungen (mm)			ANKX 1607	
L	S	A		
16	10,4	11	A	S

Sipariş Kodu Order Code Best.-Nr.	Stok/Stock/Lager	Ürün Kodu Product Code Produkt-Code	Ölçüler (mm) Dimensions (mm) Abmessungen (mm)				Kullanılan Uç Insert WSP	Sıkma Civatası Clamp Screw Torx-Schraube	Anahtar Torx Key Torx-Schlüssel
			ØD	ød	Z	H			
T171	●	D050 d22 Z04 AN--16	50	22	4	40			
T172	●	D063 d22 Z05 AN--16	63	22	5	40			
T173	●	D080 d27 Z06 AN--16	80	27	6	50			

GSC ucuna uygundur. / Compatible with GSC insert. / Kompatible für GSC WP

T45
ZDEW 1204

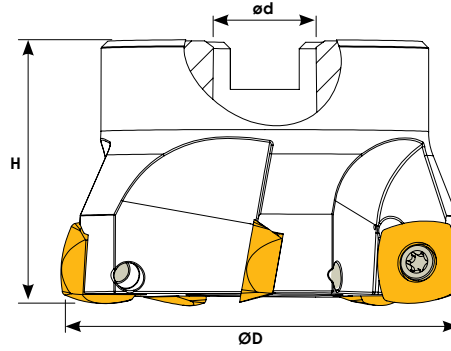

Ölçüler (mm) Dimensions (mm) Abmessungen (mm)			ZDEW 1204	
l	S	d		
12,7	4,76	12,7		

Sipariş Kodu Order Code Best.-Nr.	Stok/Stock/Lager	Ürün Kodu Product Code Produkt-Code	Ölçüler (mm) Dimensions (mm) Abmessungen (mm)				Kullanılan Uç Insert WSP	Sıkma Cıvatası Clamp Screw Torx-Schraube	Anahtar Torx Key Torx-Schlüssel
			ØD	ød	Z	H			
T196	●	D050 d22 Z04 ZD--12	50	22	4	40	ZDEW 1204 PRMT	TC080-1 M4,5x11	T15
T197	●	D063 d22 Z05 ZD--12	63	22	5	40			

T46
55° HNGX 0906

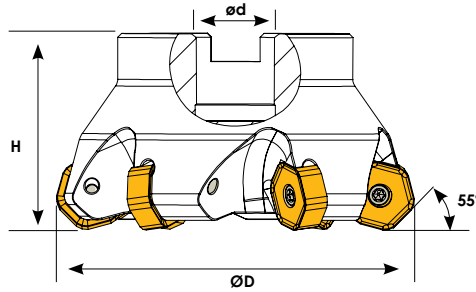

Ölçüler (mm) Dimensions (mm) Abmessungen (mm)		HNGX 0906	
d	S		
16,5	6,3		

Sipariş Kodu Order Code Best.-Nr.	Stok/Stock/Lager	Ürün Kodu Product Code Produkt-Code	Ölçüler (mm) Dimensions (mm) Abmessungen (mm)				Kullanılan Uç Insert WSP	Sıkma Cıvatası Clamp Screw Torx-Schraube	Anahtar Torx Key Torx-Schlüssel
			ØD	ød	Z	H			
T418	●	D063 d22 Z06 HN--09	63	22	6	40	HNGX 0906 PRMT	TC080 M4,5x11	T15
T419	●	D080 d27 Z06 HN--09	80	27	6	50			
T420	●	D100 d32 Z08 HN--09	100	32	8	50			
T421	●	D125 d40 Z08 HN--09	125	40	8	63			
T422	●	D160 d40 Z12 HN--09	160	40	12	63			

PRMT ucuna uygundur. / Compatible with PRMT insert. / Kompatible für PRMT WP

**T47
SDMT 09T3**

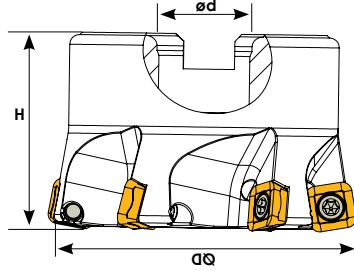

Ölçüler (mm) Dimensions(mm) Abmessungen (mm)		SDMT 09T3	
L	S		
9,52	3,97		

Sipariş Kodu Order Code Best.-Nr.	Stok/Stock/Lager	Ürün Kodu Product Code Produkt-Code	Ölçüler (mm) Dimensions(mm) Abmessungen (mm)				Kullanılan Uç Insert WSP	Sıkma Civatası Clamp Screw Torx-Schraube	Anahtar Torx Key Torx-Schlüssel
			ØD	ød	Z	H			
T362	●	D040 d16 Z04 SD--09	40	16	4	40			
T363	●	D050 d22 Z05 SD--09	50	22	5	40	SDMT 09T3 ZCC	TC067 M3,5x9	T15
T364	●	D063 d27 Z06 SD--09	63	27	6	40			

**T48
SDMT 1204**

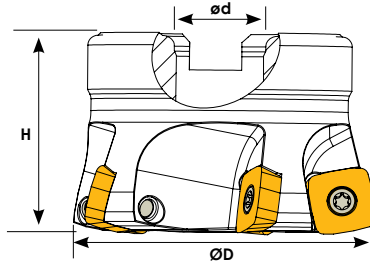

Ölçüler (mm) Dimensions(mm) Abmessungen (mm)		SDMT 1204	
L	S		
12,7	4,76		

Sipariş Kodu Order Code Best.-Nr.	Stok/Stock/Lager	Ürün Kodu Product Code Produkt-Code	Ölçüler (mm) Dimensions(mm) Abmessungen (mm)				Kullanılan Uç Insert WSP	Sıkma Civatası Clamp Screw Torx-Schraube	Anahtar Torx Key Torx-Schlüssel
			ØD	ød	Z	H			
T358	●	D050 d22 Z04 SD--12	50	22	4	40			
T359	●	D063 d22 Z05 SD--12	63	22	5	40	SDMT 1204 ZCC	TC074 M4x10	T15
T360	●	D080 d27 Z06 SD--12	80	27	6	52			

**T49
SPMT 1204**

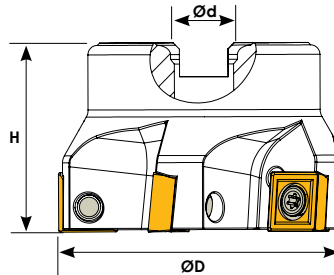

Ölçüler (mm) Dimensions(mm) Abmessungen (mm)		SPMT 1204	
L	S		
12,7	4,76		

Sipariş Kodu Order Code Best.-Nr.	Stok/Stock/Lager	Ürün Kodu Product Code Produkt-Code	Ölçüler (mm) Dimensions(mm) Abmessungen (mm)				Kullanılan Uç Insert WSP	Sıkma Civatası Clamp Screw Torx-Schraube	Anahtar Torx Key Torx-Schlüssel
			ØD	ød	Z	H			
T236	●	D050 d22 Z04 SP--12	50	22	4	40			
T237	●	D063 d27 Z05 SP--12	63	27	5	50	SP-- 1204 ZCC	TC085 M5x12	T20
T238	●	D080 d27 Z06 SP--12	80	27	6	50			

ZCC ucuna uygundur. / Compatible with ZCC insert. / Kompatible für ZCC WP

T50 45° SEET 12T3

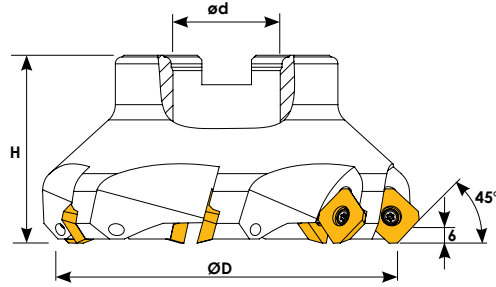
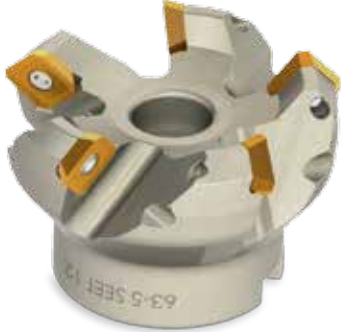

Ölçüler (mm) Dimensions(mm) Abmessungen (mm)		SEET 12T3	
L	S	SEET 12T3	
13,4	3,97		

Sipariş Kodu Order Code Best.-Nr.	Stok/Stock/Lager	Ürün Kodu Product Code Produkt-Code	Ölçüler (mm) Dimensions(mm) Abmessungen (mm)				Kullanılan Uç Insert WSP	Sıkma Cıvatası Clamp Screw Torx-Schraube	Anahtar Torx Key Torx-Schlüssel
			ØD	ød	Z	H			
T435	●	D063 d22 Z05 SE--12	63	22	5	50	SEET 12T3 ZCC	TC067 M3,5x9	T15
T436	●	D080 d27 Z06 SE--12	80	27	6	52			
T437	●	D100 d32 Z07 SE--12	100	32	7	55			
T438	●	D125 d40 Z08 SE--12	125	40	8	62			

T51 45° SEET 12T3-A

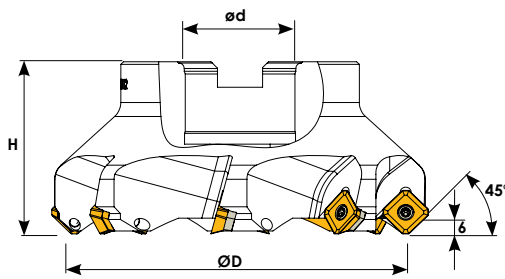

Ölçüler (mm) Dimensions(mm) Abmessungen (mm)		SEET 12T3	
L	S	SEET 12T3	
13,4	3,97		



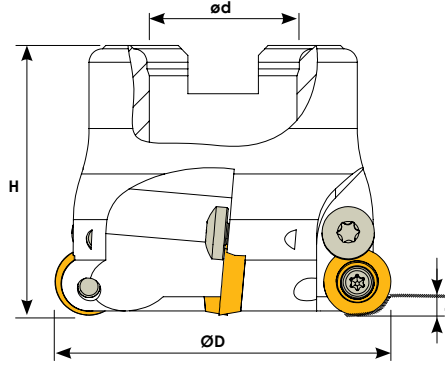

Sipariş Kodu Order Code Best.-Nr.	Stok/Stock/Lager	Ürün Kodu Product Code Produkt-Code	Ölçüler (mm) Dimensions(mm) Abmessungen (mm)				Kullanılan Uç Insert WSP	Sıkma Cıvatası Clamp Screw Torx-Schraube	Altlık Shim U-Platte	Altlık Cıvatası Shim Screw Inbuss-Schraube	Anahtar Torx Key Torx-Schlüssel
			ØD	ød	Z	H					
T560	●	D050 d22 Z04 SE--12	50	22	4	40	SEET 12T3 ZCC	TC068 M3,5x11	TA052	TC049 M5x7	T15
T562	●	D063 d22 Z05 SE--12	63	22	5	40					
T564	●	D080 d27 Z06 SE--12	80	27	6	50					
T566	●	D100 d32 Z07 SE--12	100	32	7	50					
T568	●	D125 d40 Z08 SE--12	125	40	8	63					
T570	●	D160 d40 Z10 SE--12	160	40	10	63					

ZCC ucuna uygundur. / Compatible with ZCC insert. / Kompatible für ZCC WP

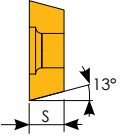
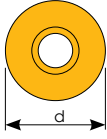
T52
RHKW 0802



Ölçüler (mm) Dimensions (mm) Abmessungen (mm)		RHKW 0802	
d	S		
8	2,60		

Sipariş Kodu Order Code Best.-Nr.	Stok/Stock/Lager	Ürün Kodu Product Code Produkt-Code	Ölçüler (mm) Dimensions (mm) Abmessungen (mm)				Kullanılan Uç Insert WSP	Baskı Civatası Locking Screw Verriegelungs Schraube	Sıkma Civatası Clamp Screw Torx-Schraube	Anahtar Torx Key Torx-Schlüssel
			ØD	ød	Z	H				
T599	●	D040 d16 Z04 RH--08	40	16	4	40				
T600	●	D050 d22 Z05 RH--08	50	22	5	40	RHKW 0802 INGRSL	TC040 M3,5	TC065 M3x7	T8 T15
T601	●	D063 d22 Z06 RH--08	63	22	6	40				

T53
RHKW 1003

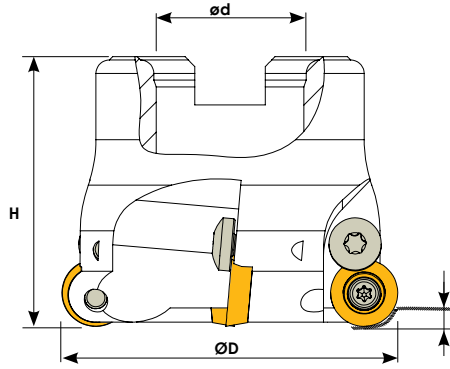

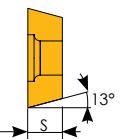
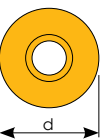
Ölçüler (mm) Dimensions (mm) Abmessungen (mm)		RHKW 1003	
d	S		
10	3,8		

Sipariş Kodu Order Code Best.-Nr.	Stok/Stock/Lager	Ürün Kodu Product Code Produkt-Code	Ölçüler (mm) Dimensions (mm) Abmessungen (mm)				Kullanılan Uç Insert WSP	Baskı Civatası Locking Screw Verriegelungs Schraube	Sıkma Civatası Clamp Screw Torx-Schraube	Anahtar Torx Key Torx-Schlüssel
			ØD	ød	Z	H				
T602	●	D040 d16 Z04 RH--10	40	16	4	40	RHKW 1003 INGRSL	TC040 M3,5	TC074 M4x10	T15
T604	●	D050 d22 Z05 RH--10	50	22	5	40				
T606	●	D063 d22 Z06 RH--10	63	22	6	40				
T608	●	D080 d27 Z07 RH--10	80	27	7	50				

INGRSL ucuna uygundur. / Compatible with INGRSL insert. / Kompatible für INGRSL WP

T54 RHKW 1204

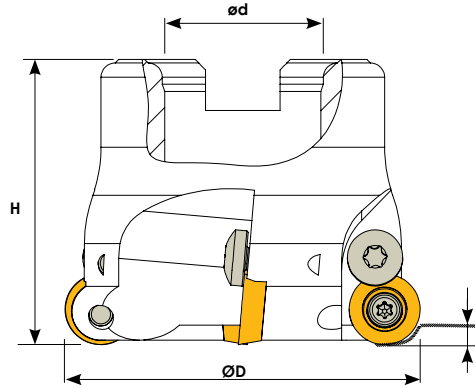

Ölçüler (mm) Dimensions (mm) Abmessungen (mm)		RHKW 1204	
d	S		
12	4,76		

Sipariş Kodu Order Code Best.-Nr.	Stok/Stock/Lager	Ürün Kodu Product Code Produkt-Code	Ölçüler (mm) Dimensions (mm) Abmessungen (mm)				Kullanılan Uç Insert WSP	Baskı Cıvatası Locking Screw Verriegelungs Schraube	Sıkma Cıvatası Clamp Screw Torx-Schraube	Anahtar Torx Key Torx-Schlüssel
			ØD	ød	Z	H				
T612	●	D040 d16 Z04 RH--12	40	16	4	40				
T613	●	D050 d22 Z05 RH--12	50	22	5	40				
T614	●	D063 d22 Z06 RH--12	63	22	6	45				
T615	●	D080 d27 Z07 RH--12	80	27	7	50				

T55 90° BOMT 1304

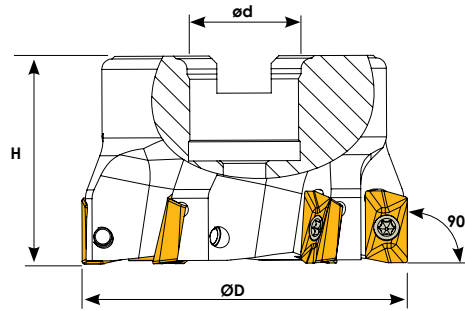

Ölçüler (mm) Dimensions (mm) Abmessungen (mm)			BOMT 1304	
L	S	A		
13	4,5	8		

Sipariş Kodu Order Code Best.-Nr.	Stok/Stock/Lager	Ürün Kodu Product Code Produkt-Code	Ölçüler (mm) Dimensions (mm) Abmessungen (mm)				Kullanılan Uç Insert WSP	Sıkma Cıvatası Clamp Screw Torx-Schraube	Anahtar Torx Key Torx-Schlüssel
			ØD	ød	Z	H			
T965	●	D040 d16 Z04 BO--13	40	16	4	40			
T966	●	D050 d22 Z05 BO--13	50	22	5	40			
T967	●	D063 d22 Z06 BO--13	63	22	6	40			

INGRSLL ucuna uygundur. / Compatible with INGRSLL insert. / Kompatibel für INGRSLL WP

RDMT 1003

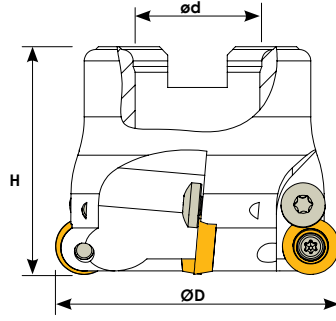

Ölçüler (mm) Dimensions (mm) Abmessungen (mm)		RDMT 1003	
d	S		
10	3,18		

Sipariş Kodu Order Code Best.-Nr.	Stok/Stock/Lager	Ürün Kodu Product Code Produkt-Code	Ölçüler (mm) Dimensions (mm) Abmessungen (mm)				Kullanılan Uç Insert WSP	Baskı Cıvatası Locking Screw Verriegelungs Schraube	Sıkma Cıvatası Clamp Screw Torx-Schraube	Anahtar Torx Key Torx-Schlüssel
			ØD	ød	Z	H				
T288	●	D040 d16 Z03 RD--10	40	16	3	40	RD--1003 ISO	TC040 M3,5	TC067 M3,5x9	T15
T289	●	D040 d16 Z04 RD--10	40	16	4	40				
T290	●	D050 d22 Z04 RD--10	50	22	4	40				
T291	●	D050 d22 Z05 RD--10	50	22	5	40				
T292	●	D063 d22 Z05 RD--10	63	22	5	40				
T293	●	D063 d22 Z06 RD--10	63	22	6	40				
T294	●	D080 d27 Z06 RD--10	80	27	6	50				
T294-1	●	D080 d27 Z07 RD--10	80	27	7	50				
T295	●	D100 d32 Z07 RD--10	100	32	7	50				
T295-1	●	D100 d32 Z08 RD--10	100	32	8	50				

1003 ISO'dur. / RDMT 1003 is ISO. / Kompatible für ISO WP

RDMT 12T3

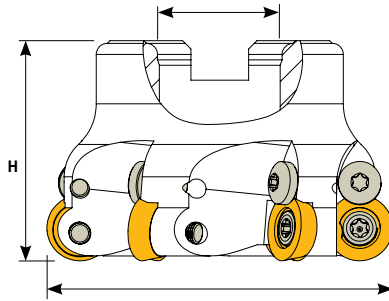

Ölçüler (mm) Dimensions (mm) Abmessungen (mm)		RDMT 12T3	
d	S		
12	3,97		

Sipariş Kodu Order Code Best.-Nr.	Stok/Stock/Lager	Ürün Kodu Product Code Produkt-Code	Ölçüler (mm) Dimensions (mm) Abmessungen (mm)				Kullanılan Uç Insert WSP	Baskı Cıvatası Locking Screw Verriegelungs Schraube	Sıkma Cıvatası Clamp Screw Torx-Schraube	Anahtar Torx Key Torx-Schlüssel
			ØD	ød	Z	H				
T280	●	D040 d16 Z03 RD--12	40	16	3	40	RD-- 12T3 ISO	TC040 M3,5	TC067 M3,5x9	T15
T281	●	D040 d16 Z04 RD--12	40	16	4	40				
T282	●	D050 d22 Z04 RD--12	50	22	4	40				
T283	●	D050 d22 Z05 RD--12	50	22	5	40				
T284	●	D063 d22 Z05 RD--12	63	22	5	40				
T285	●	D063 d22 Z06 RD--12	63	22	6	40				
T286	●	D080 d27 Z06 RD--12	80	27	6	50				
T286-1	●	D080 d27 Z07 RD--12	80	27	7	50				
T287	●	D100 d32 Z07 RD--12	100	32	7	50				
T287-1	●	D100 d32 Z08 RD--12	100	32	8	50				

RDMT 12T3 ISO'dur. / RDMT 12T3 is ISO. / Kompatible für ISO WP

RDMT 1604

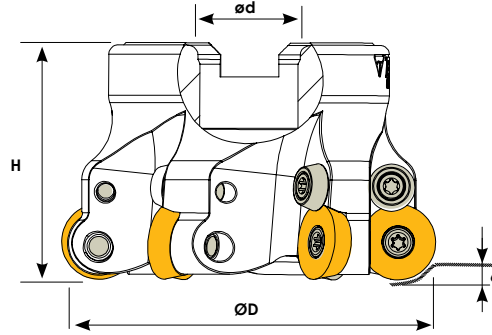

Ölçüler (mm) Dimensions(mm) Abmessungen (mm)		RD-- 1604	
d	S		
16	4,76		

Sipariş Kodu Order Code Best.-Nr.	Stok/Stock/Lager	Ürün Kodu Product Code Produkt-Code	Ölçüler (mm) Dimensions(mm) Abmessungen (mm)				Kullanılan Uç Insert WSP	Baskı Pulu Flat Washer U-Scheibe	Baskı Civatası Locking Screw Verriegelungs Schraube	Sıkma Civatası Clamp Screw Torx-Schraube	Anahtar Torx Key Torx-Schlüssel
			ØD	ød	Z	H					
T270	●	D050 d22 Z04 RD--16	50	22	4	50	RD-- 1604 ISO	BP10	TC074 M4x10	TC080 M4,5x11	T20
T271	●	D052 d22 Z04 RD--16	52	22	4	50					
T273	●	D063 d22 Z05 RD--16	63	22	5	45					
T272	●	D066 d27 Z05 RD--16	66	27	5	50					
T274	●	D080 d27 Z06 RD--16	80	27	6	50					
T275	●	D100 d32 Z07 RD--16	100	32	7	52					

RDMT 1604 ISO'dur. / RDMT 1604 is ISO. / Kompatible für ISO WP

T56 90° LNGU 15T6

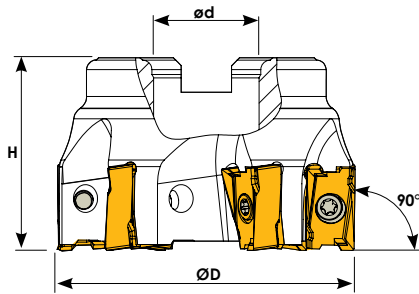

Ölçüler (mm) Dimensions(mm) Abmessungen (mm)			LNGU 15T6	
L	S	A		
17	6,96	10		

Sipariş Kodu Order Code Best.-Nr.	Stok/Stock/Lager	Ürün Kodu Product Code Produkt-Code	Ölçüler (mm) Dimensions(mm) Abmessungen (mm)				Kullanılan Uç Insert WSP	Sıkma Civatası Clamp Screw Torx-Schraube	Anahtar Torx Key Torx-Schlüssel
			ØD	ød	Z	H			
T956	●	D050 d22 Z05 LN--15	50	22	5	40	LNGU 15T6 KNNMTL	TC075 M4x11	T15
T958	●	D063 d22 Z06 LN--15	63	22	6	40			
T960	●	D080 d27 Z07 LN--15	80	27	7	50			
T961	●	D100 d32 Z08 LN--15	100	32	8	50			

KNNMTL ucuna uygundur. / Compatible with KNNMTL insert. / Kompatible für KNNMTL WP

75° SPKN 1203

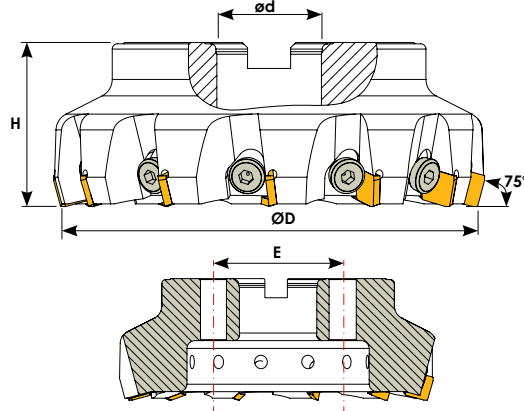

Ölçüler (mm)
Dimensions (mm)
Abmessungen (mm)

L	S
12,7	3,18

SPKN 1203

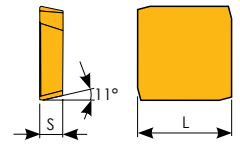

Sipariş Kodu Order Code Best.-Nr.	Stok/Stock/Lager	Ürün Kodu Product Code Produkt-Code	Ölçüler (mm) Dimensions (mm) Abmessungen (mm)					Kullanılan Uç Insert WSP	Sıkma Civatası Clamp Screw Inbuss-Schraube	Anahtar Allen Key Inbuss-Schlüssel
			ØD	ød	Z	H	E			
T152	●	D080 d27 Z06 SP--12	80	27	6	55	---	SPKN 1203 ISO	TC056 Sol M8x24-L	5 Allen
T154	●	D100 d32 Z08 SP--12	100	32	8	55	---			
T156	●	D125 d40 Z10 SP--12	125	40	10	62	---			
T158	●	D160 d40 Z12 SP--12	160	40	12	62	66,7			
T160	●	D200 d60 Z12 SP--12	200	60	12	62	101,6			
T162	●	D300 d60 Z20 SP--12	300	60	20	65	101,6			

75° SPKN 1203

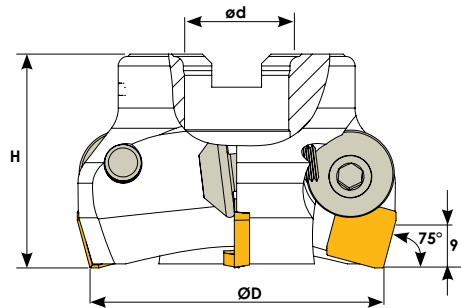

Ölçüler (mm)
Dimensions (mm)
Abmessungen (mm)

L	S
12,7	3,18

SPKN 1203

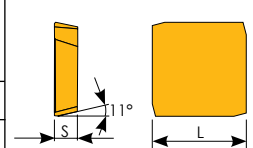

Sipariş Kodu Order Code Best.-Nr.	Stok/Stock/Lager	Ürün Kodu Product Code Produkt-Code	Ölçüler (mm) Dimensions (mm) Abmessungen (mm)				Kullanılan Uç Insert WSP	Sıkma Civatası Clamp Screw Inbuss-Schraube	Anahtar Allen Key Inbuss-Schlüssel
			ØD	ød	Z	H			
T148	●	D050 d22 Z03 SP--12	50	22	3	45	SPKN 1203 ISO	TC054 M8x24	5 Allen
T150	●	D063 d22 Z04 SP--12	63	22	4	45			

SPKN 1203 ISO'dur. / SPKN 1203 is ISO. / Kompatible für ISO WP

90° TPKN 1603-2204

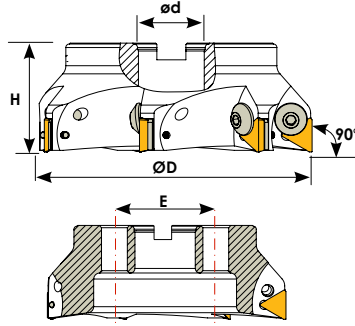

Ölçüler (mm) Dimensions (mm) Abmessungen (mm)		TPKN 1603	
L	S		
16,5	3,18		
22	4,76		

Altlıklı - With Shim - Mit U-Platte

Sipariş Kodu Order Code Best.-Nr.	Stok/Stock/Lager	Ürün Kodu Product Code Produkt-Code	Ölçüler (mm) Dimensions (mm) Abmessungen (mm)					Kullanılan Uç Insert WSP	Baskı Cıvatası Locking Screw Verriegelungs-Schraube	Altlık Shim U-Platte	Altlık Cıvatası Shim Screw Inbuss-Schraube	Anahtar Allen Key Inbuss-Schlüssel
			ØD	ød	Z	H	E					
T100	●	D080 d32 Z05 TP--16 A	80	32	5	52	--	TPKN 1603 ISO	TC052 M6x17	TA010	TC045 M3	4 Allen
T102	●	D100 d32 Z06 TP--16 A	100	32	6	52	--					
T104	●	D080 d32 Z04 TP--22 A	80	32	4	52	--	TPKN 2204 ISO	TC054 M8x24	TA012	TC038 M4x10	5 Allen
T106	●	D100 d32 Z05 TP--22 A	100	32	5	52	--					
T108	●	D125 d40 Z06 TP--22 A	125	40	6	62	--					
T110	●	D160 d40 Z07 TP--22 A	160	40	7	62	66,7					
T112	●	D200 d60 Z08 TP--22A	200	60	8	62	101,6					
T113	●	D250 d60 Z09 TP--22 A	250	60	9	62	101,6					

TPKN 1603-2204 ISO'dur. / TPKN 1603-2204 is ISO. / Kompatible für ISO WP

90° TPKN 1603-2204

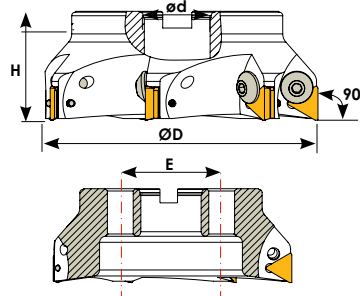

Ölçüler (mm) Dimensions (mm) Abmessungen (mm)		TPKN 1603	
L	S		
16,5	3,18		
22	4,76		

Sipariş Kodu Order Code Best.-Nr.	Stok/Stock/Lager	Ürün Kodu Product Code Produkt-Code	Ölçüler (mm) Dimensions (mm) Abmessungen (mm)					Kullanılan Uç Insert WSP	Sıkma Cıvatası Clamp Screw Inbuss-Schraube	Anahtar Allen Key Inbuss-Schlüssel
			ØD	ød	Z	H	E			
T114	●	D042 d16 Z03 TP--16	42	16	3	44	--	TPKN 1603 ISO	TC052 M6x17	4 Allen
T116	●	D050 d22 Z03 TP--16	50	22	3	44	--			
T118	●	D063 d22 Z03 TP--16	63	22	3	44	--			
T120	●	D063 d22 Z04 TP--16	63	22	4	44	--			
T122	●	D080 d32 Z05 TP--16	80	32	5	52	--			
T124	●	D100 d32 Z06 TP--16	100	32	6	52	--			
T126	●	D063 d22 Z03 TP--22	63	22	3	50	--	TPKN 2204 ISO	TC054 M8x24	5 Allen
T128	●	D080 d32 Z04 TP--22	80	32	4	52	--			
T130	●	D100 d32 Z05 TP--22	100	32	5	52	--			
T132	●	D125 d40 Z06 TP--22	125	40	6	62	--			
T134	●	D160 d40 Z07 TP--22	160	40	7	62	66,7			
T136	●	D200 d60 Z08 TP--22	200	60	8	62	101,6			
T138	●	D250 d60 Z09 TP--22	250	60	9	62	101,6			

TPKN 1603-2204 ISO'dur. / TPKN 1603-2204 is ISO. / Kompatible für ISO WP



Baralar
Boring Tools
Ausbohrwerkzeug

www.teknikcuttingtools.com



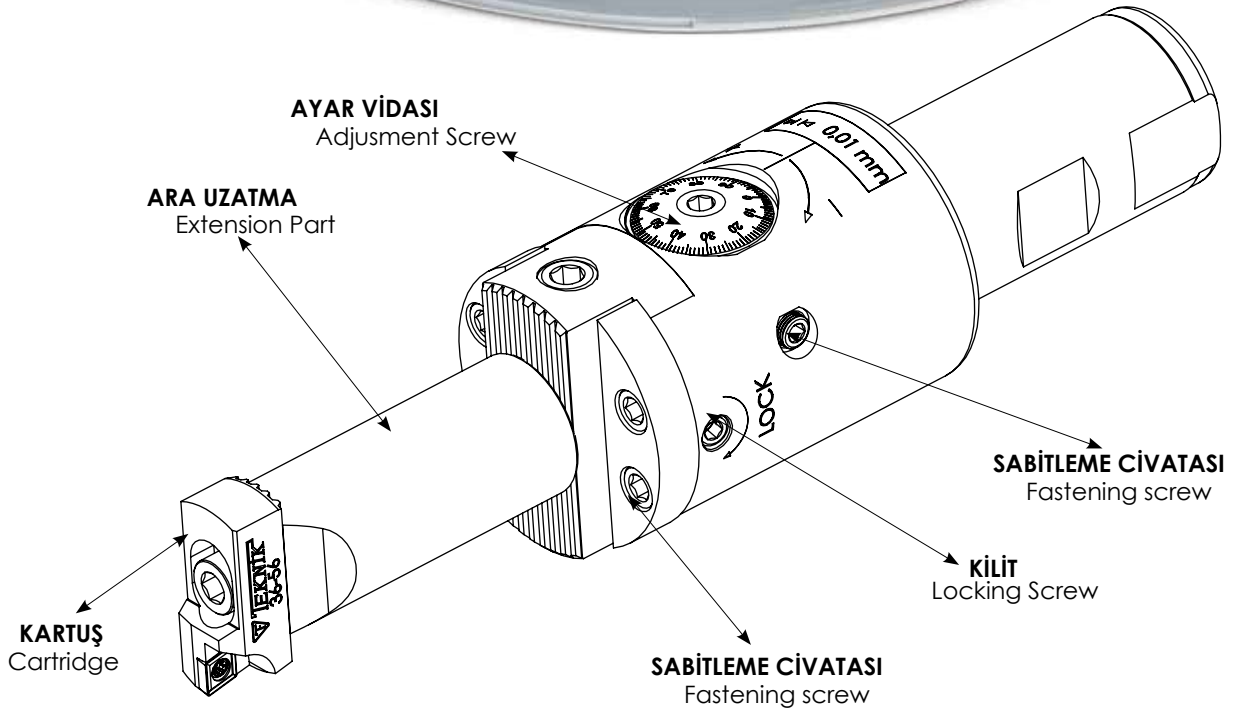
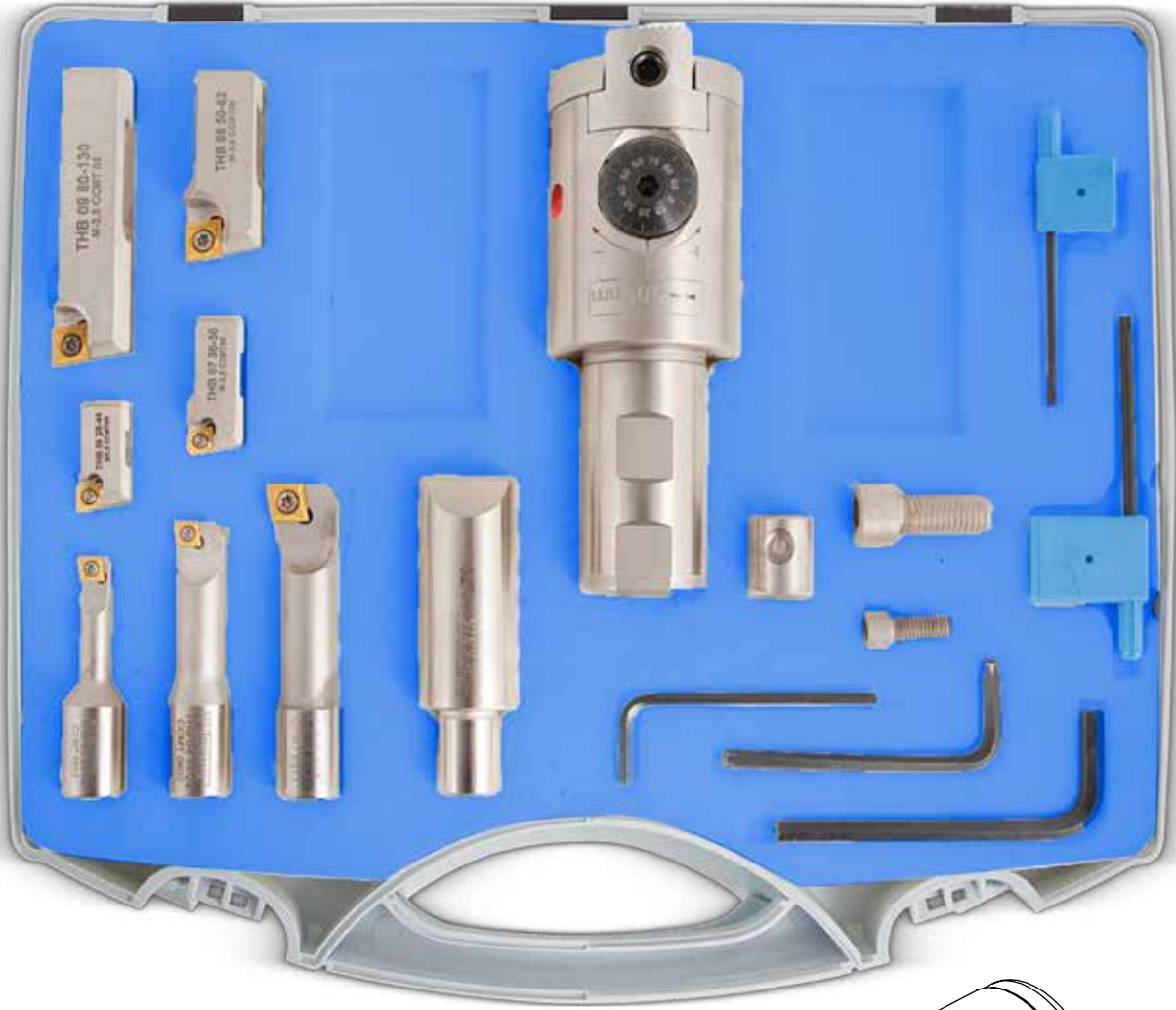

THB 01 SET (1 Gövde + 7 Kartuş)

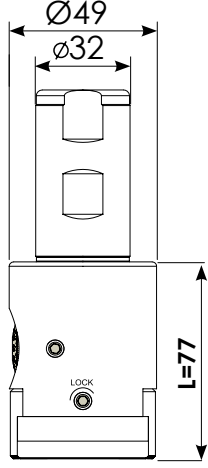

**THB 02
GÖVDE
BODY**

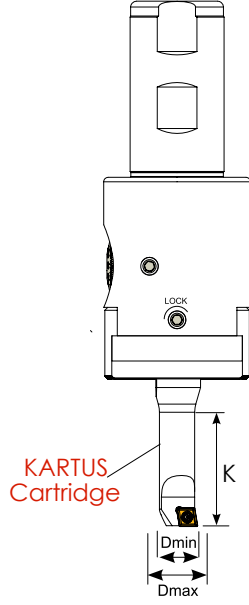

**THB 03
(9-18)**

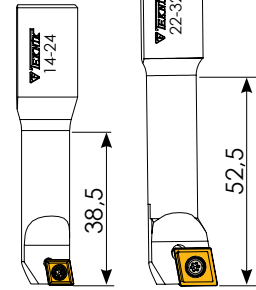

**THB 04
(14-24)**

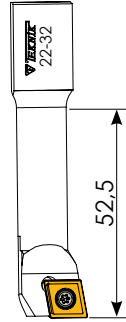

**THB 05
(22-32)**

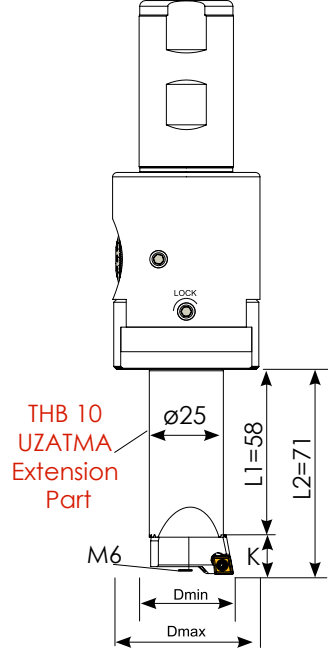

**THB 06
(28-44)**

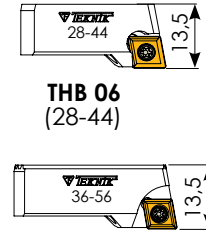

**THB 07
(36-56)**

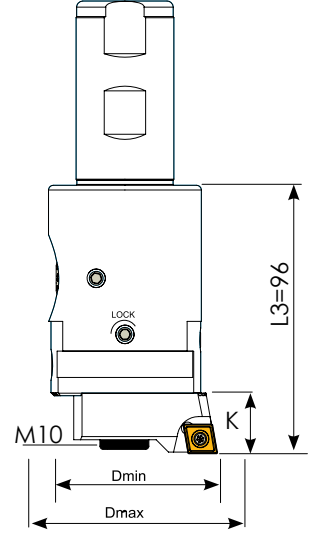

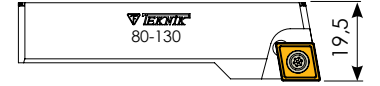

**THB 08
(50-82)**

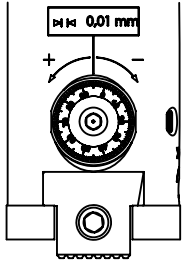

**THB 09
(80-130)**

**HASSASİYET
Fine / Fein**

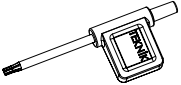

Sipariş Kodu Order Code Best.-Nr.	Stok/Stock/Lager	Ürün Kodu Product Code Produkt-Code	K	L1	L2	L3	Dmin - Dmax	Kullanılan Uç Insert WSP	Sıkma Cıvatası Clamp Screw Torx-Schraube	Anahtar Torx Key Torx-Schlüssel
										
THB 01	●	HASSAS BARA SETİ / SET	9-130
THB 02	●	GÖVDE / BODY
THB 03	●	09-18 Kartuş/Cartridge	32,5	9-18	CC -- 0602	TC060 M2,5x5,5	T8
THB 04	●	14-24 Kartuş/Cartridge	39,6	14-24	CC -- 0602	TC060 M2,5x5,5	T8
THB 05	●	22-32 Kartuş /Cartridge	52,5	22-32	CC -- 09T3	TC067 M3,5x9	T15
THB 06	●	28-44 Kartuş/Cartridge	13,7	...	71	...	28-44	CC -- 0602	TC060 M2,5x5,5	T8
THB 07	●	36-56 Kartuş /Cartridge	13,7	...	71	...	36-56	CC -- 0602	TC060 M2,5x5,5	T8
THB 08	●	50-82 Kartuş/Cartridge	19,5	95,5	50-82	CC -- 09T3	TC067 M3,5x8,5	T15
THB 09	●	80-130 Kartuş/Cartridge	19,5	95,5	80-130	CC -- 09T3	TC067 M3,5x8,5	T15
THB 10	●	ARA UZATMA/Extension Part	...	58



Sipari# Kodu Order Code Best.-Nr.	Stok/Stock/Lager	#r#n Kodu Product Code Produkt-Code	#l#ler (mm) Dimensions(mm) Abmessungen (mm)							Kullanılan U# Insert WSP	Hassasiyet Fine Fein
			Dmin	Dmax	K	øD1	L1	øD2	L		
THKB120	●	25-32 K050 CC--06	25	32	50	25	56	23	106	CC -- 0602	0,02
THKB122	●	25-32 K100 CC--06	25	32	100	25	56	23	156		
THKB126	●	32-40 K060 CC--06	32	40	60	25	56	29	116	CC -- 0602	0,01
THKB128	●	32-40 K104 CC--06	32	40	104	25	56	29	160		
THKB132	●	40-50 K069 CC--06	40	50	69	25	56	36	125		
THKB134	●	40-50 K110 CC--06	40	50	109	25	56	36	165		
THKB136	●	40-50 K190 CC--06	40	50	189	25	56	36	245	CC -- 09T3	0,01
THKB138	●	50-65 K065 CC--09	50	65	65	32	60	47	125		
THKB140	●	50-65 K130 CC--09	50	65	130	32	60	47	190		
THKB142	●	50-65 K220 CC--09	50	65	220	32	60	47	280		
THKB144	●	65-80 K085 CC--09	65	80	85	32	60	60	145		
THKB146	●	65-80 K130 CC--09	65	80	130	32	60	60	190		
THKB148	●	65-80 K220 CC--09	65	80	220	32	60	60	280		

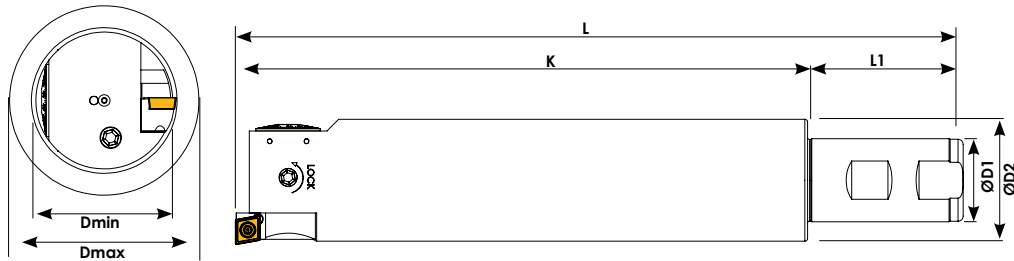

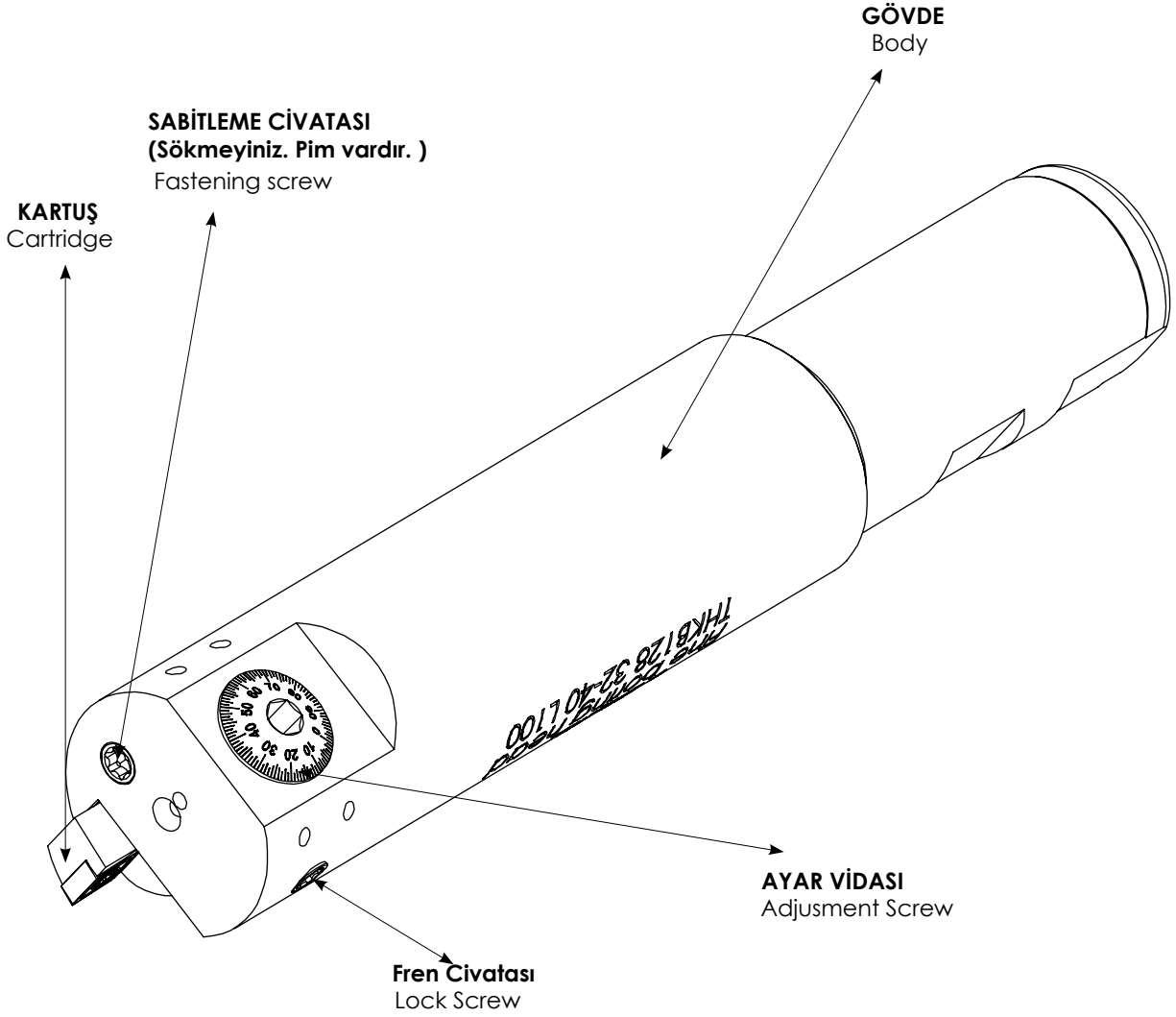

Dmin-Dmax	KartuŐlar Cartridges Kartusche	Kullanılan U# Insert WSP	Sıkma Cıvatası Clamp Screw Torx-Schraube	Sabitleme Cıvatası Locking Screw Verriegelungs Schraube	Ayar Cıvatası Adjustment Screw Einstell- schraube	Anahtar Torx Key Torx-Schl#ssel	
25-32	KR150	CC--0602	TC060 M2,5x5,5	SK47-M6x6	PC14-M5x17	T8	2,5 Allen
32-40	KR151	CC--0602	TC060 M2,5x5,5	SK47-M5x6	PC16-M5x19	T8	2,5 Allen
40-50	KR152	CC--0602	TC060 M2,5x5,5	SK47-M6x6	PC18-M5x23	T8	
50-65	KR153	CC--09T3	TC067 M3,5x9	SK48-M8x8	PC22-M8x37	T15	
65-80	KR154	CC--09T3	TC067 M3,5x9	SK48-M8x8	PC22-M8x37	T15	

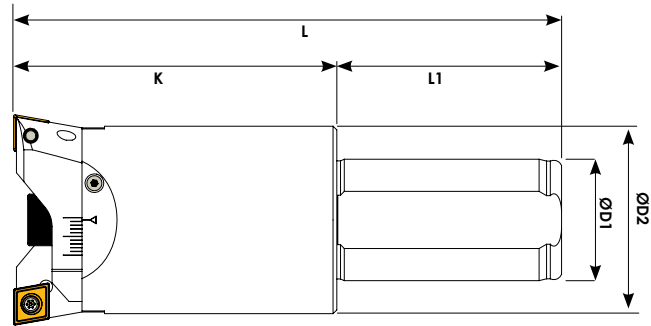
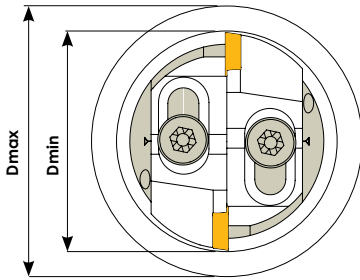

Sipariş Kodu Order Code Best.-Nr.	Stok/Stock/Lager	Ürün Kodu Product Code Produkt-Code	Ölçüler (mm) Dimensions(mm) Abmessungen (mm)							Kullanılan Uç Insert WSP
			Dmin	Dmax	K	øD1	L1	øD2	L	
TKB088	●	16-20 K052 WC--03	16	20	52	16	48	15,7	100	WC-- 0302
TKB090	●	16-20 K102 WC--03	16	20	102	16	48	15,7	150	
TKB092	●	16-20 K152 WC--03	16	20	152	16	48	15,7	200	
TKB094	●	19-23 K052 CC--06	19	23	52	16	48	17,7	100	CC -- 0602
TKB096	●	19-23 K102 CC--06	19	23	102	16	48	17,7	150	
TKB098	●	19-23 K152 CC--06	19	23	152	16	48	17,7	200	
TKB100	●	23-28 K050 CC--06	23	28	50	20	50	21,2	100	
TKB102	●	23-28 K100 CC--06	23	28	100	20	50	21,2	150	
TKB104	●	23-28 K185 CC--06	23	28	185	20	50	21,2	235	
TKB106	●	28-38 K055 CC--09	28	38	55	20	50	25,7	105	CC -- 09T3
TKB108	●	28-38 K105 CC--09	28	38	105	20	50	25,7	155	
TKB110	●	28-38 K174 CC--09	28	38	174	25	56	25,7	230	
TKB111	●	28-38 K274 CC--09	28	38	274	25	56	25,7	330	
TKB112	●	37-48 K064 CC--09	37	48	64	25	56	32	120	
TKB114	●	37-48 K114 CC--09	37	48	114	25	56	33	170	
TKB116	●	37-48 K204 CC--09	37	48	204	25	56	33	260	
TKB118	●	45-56 K070 CC--09	45	56	70	32	60	39,5	130	
TKB120	●	45-56 K117 CC--09	45	56	120	32	60	40	180	
TKB122	●	45-56 K200 CC--09	45	56	200	32	60	40	260	
TKB124	●	55-75 K085 CC--09	55	75	85	32	60	50	145	
TKB126	●	55-75 K135 CC--09	55	75	135	32	60	50	195	
TKB128	●	55-75 K220 CC--09	55	75	220	32	60	50	280	
TKB130	●	70-90 K085 CC--09	70	90	85	32	60	64	145	
TKB132	●	70-90 K135 CC--09	70	90	135	32	60	64	195	
TKB134	●	70-90 K220 CC--09	70	90	220	40	70	64	290	
TKB136	●	90-130 K115 CC--09	90	130	115	32	60	74	175	
TKB138	●	90-130 K165 CC--09	90	130	165	32	60	74	225	

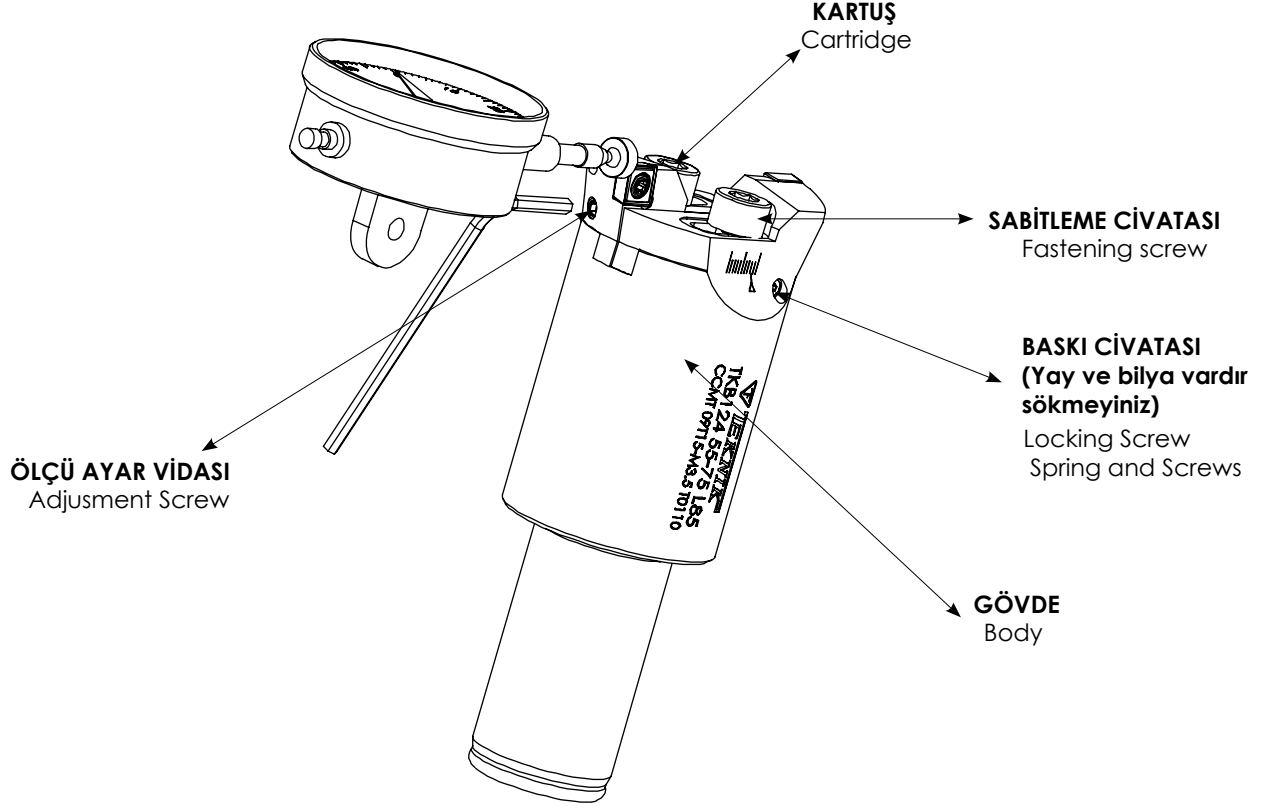

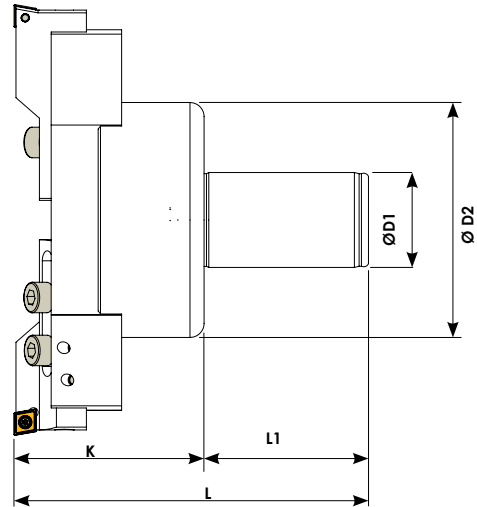
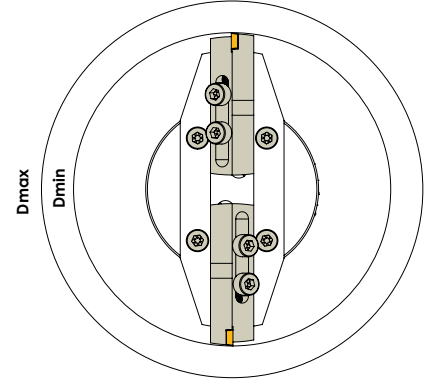

Dmin-Dmax	Kartuşlar Cartridges Kartusche	Kullanılan Uç Insert WSP	Sıkma Cıvatası Clamp Screw Torx-Schraube	Sabitleme Cıvatası Locking Screw Verriegelungs Schraube	Ayar Cıvatası Adjustment Screw Einstellschraube	Anahtar Torx Key Torx-Schlüssel
16-20	KR096	WC-- 0302	TC060 M2,5x5,5	TC102-M4x16	---	T8
19-23	KR098	CC-- 0602	TC060 M2,5x5,5	TC102-M4x16	---	T8
23-28	KR100	CC-- 0602	TC060 M2,5x5,5	TC104-M5x25	SK30-M3x5	T8
28-38	KR102	CC-- 09T3	TC067 M3,5x9	TC104-M5x25	SK32-M4x7	T15
37-48	KR104	CC-- 09T3	TC067 M3,5x9	TC106-M6x30	SK34-M4x10	T15
45-56	KR106	CC-- 09T3	TC067 M3,5x9	TC108-M8x30	SK36-M4x12	T15
55-75	KR108	CC-- 09T3	TC067 M3,5x9	TC108-M8x30	SK38-M4x16	T15
70-90	KR110	CC-- 09T3	TC067 M3,5x9	TC108-M8x30	SK38-M4x16	T15
90-130	KR112	CC-- 09T3	TC067 M3,5x9	TC108-M8x30	SK40-M4x25	T15
55-75	KR115	CC-- 1204	TC083 M5x12	TC108-M8x30	SK42-M8x30	T20
70-90	KR116	CC-- 1204	TC083 M5x12	TC108-M8x30	SK42-M8x30	T20
90-130	KR117	CC-- 1204	TC083 M5x12	TC108-M8x30	SK42-M8x30	T20

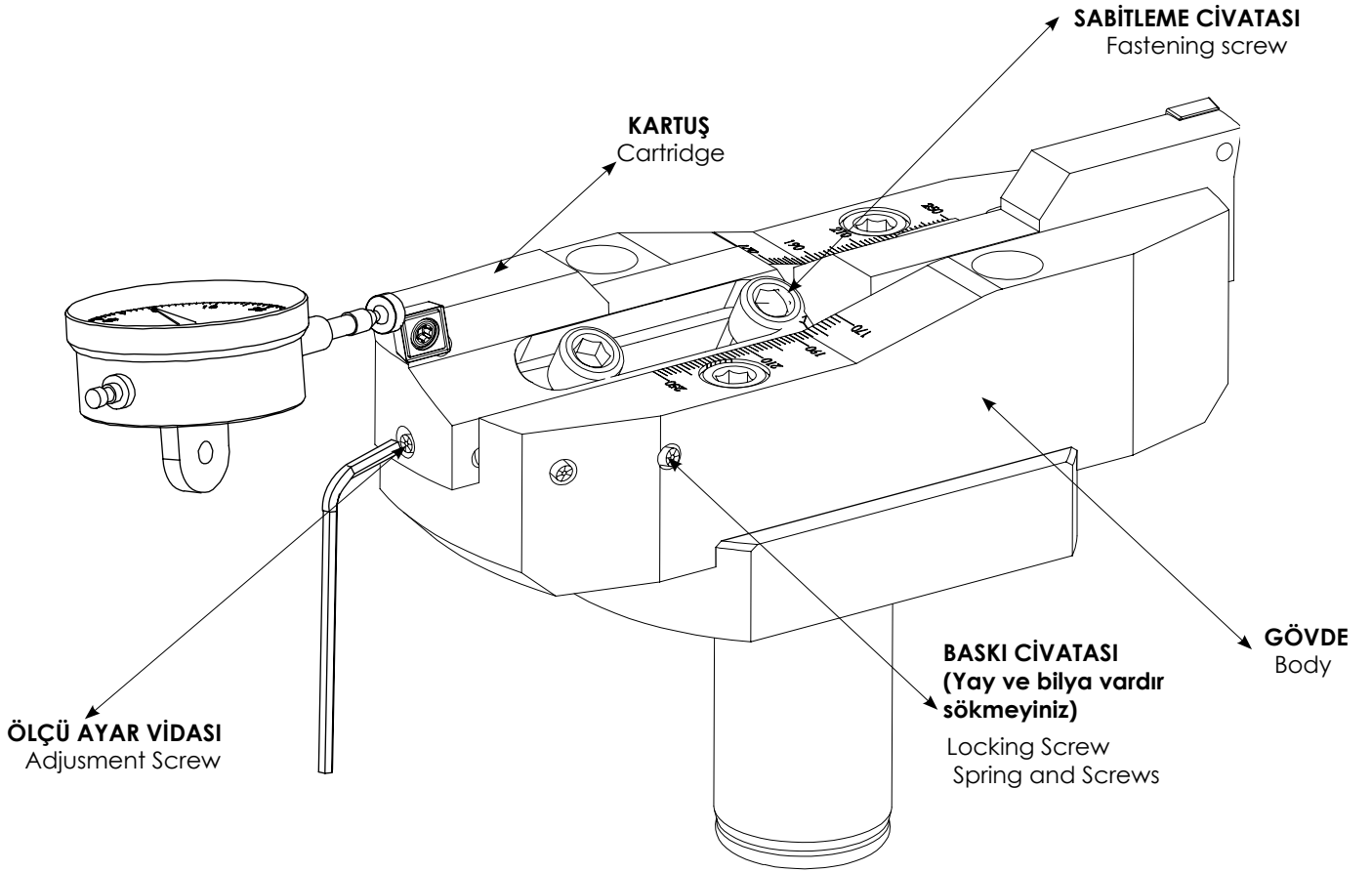

Sipariş Kodu Order Code Best.-Nr.	Stok/Stock/Lager	Ürün Kodu Product Code Produkt-Code	Ölçüler (mm) Dimensions (mm) Abmessungen (mm)							Kullanılan Uç Insert WSP
			Dmin	Dmax	K	ØD1	L1	ØD2	L	
TKB148	●	120-170 K069 CC--12	120	170	69	40	70	115,5	139	CC -- 1204
TKB150	●	170-250 K081 CC--12	170	250	81	40	70	99,5	151	
TKB152	●	240-350 K081 CC--12	240	350	81	40	70	149,5	151	

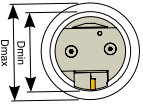
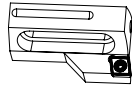

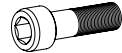
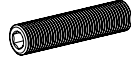
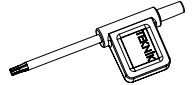

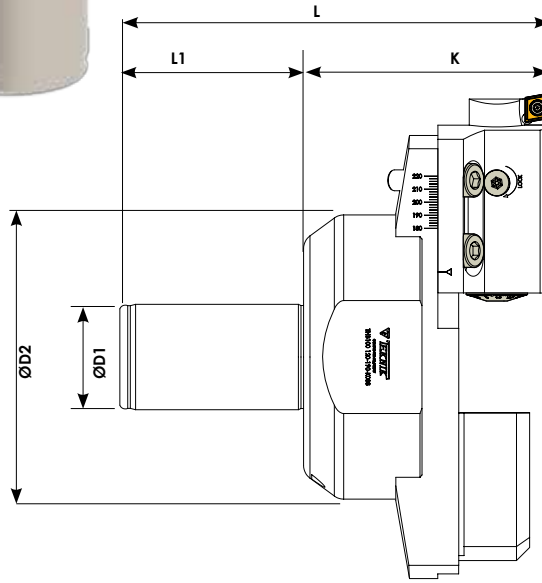
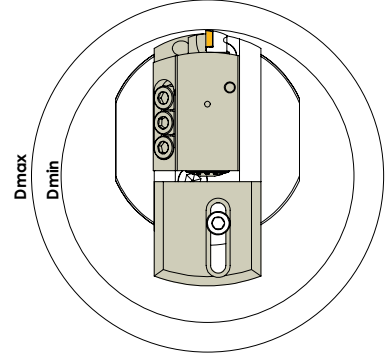
Dmin-Dmax	Kartuşlar Cartridges Kartusche	Kullanılan Uç Insert WSP	Sıkma Cıvatası Clamp Screw Torx-Schraube	Sabitleme Cıvatası Locking Screw Verriegelungs Schraube	Ayar Cıvatası Adjustment Screw Einstellschraube	Anahtar Torx Key Torx-Schlüssel
						
120-170	KR119	CC-- 1204	TC083 M5x12	TC109-M8x25	SK42-M8x30	T20
170-250	KR120	CC-- 1204	TC083 M5x12	TC109-M8x25	SK42-M8x30	T20
240-350	KR124	CC-- 1204	TC083 M5x12	TC109-M8x25	SK42-M8x30	T20

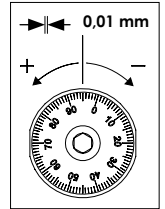

HASSASİYET
Fine / Fein



Sipariş Kodu Order Code Best.-Nr.	Stok/Stock/Lager	Ürün Kodu Product Code Produkt-Code	Ölçüler (mm) Dimensions(mm) Abmessungen (mm)							Kullanılan Uç Insert WSP	HASSASİYET Fine Fein
			Dmin	Dmax	K	øD1	L1	øD2	L		
THB100	●	120-190 K093 CC--09	120	190	93,7	40	70	109	163,7		 (mm)
THB101	●	180-240 K093 CC--09	180	240	93,7	40	70	109	163,7	CC -- 09T3	0,01
THB102	●	240-300 K093 CC--09	240	300	93,7	40	70	109	163,7		

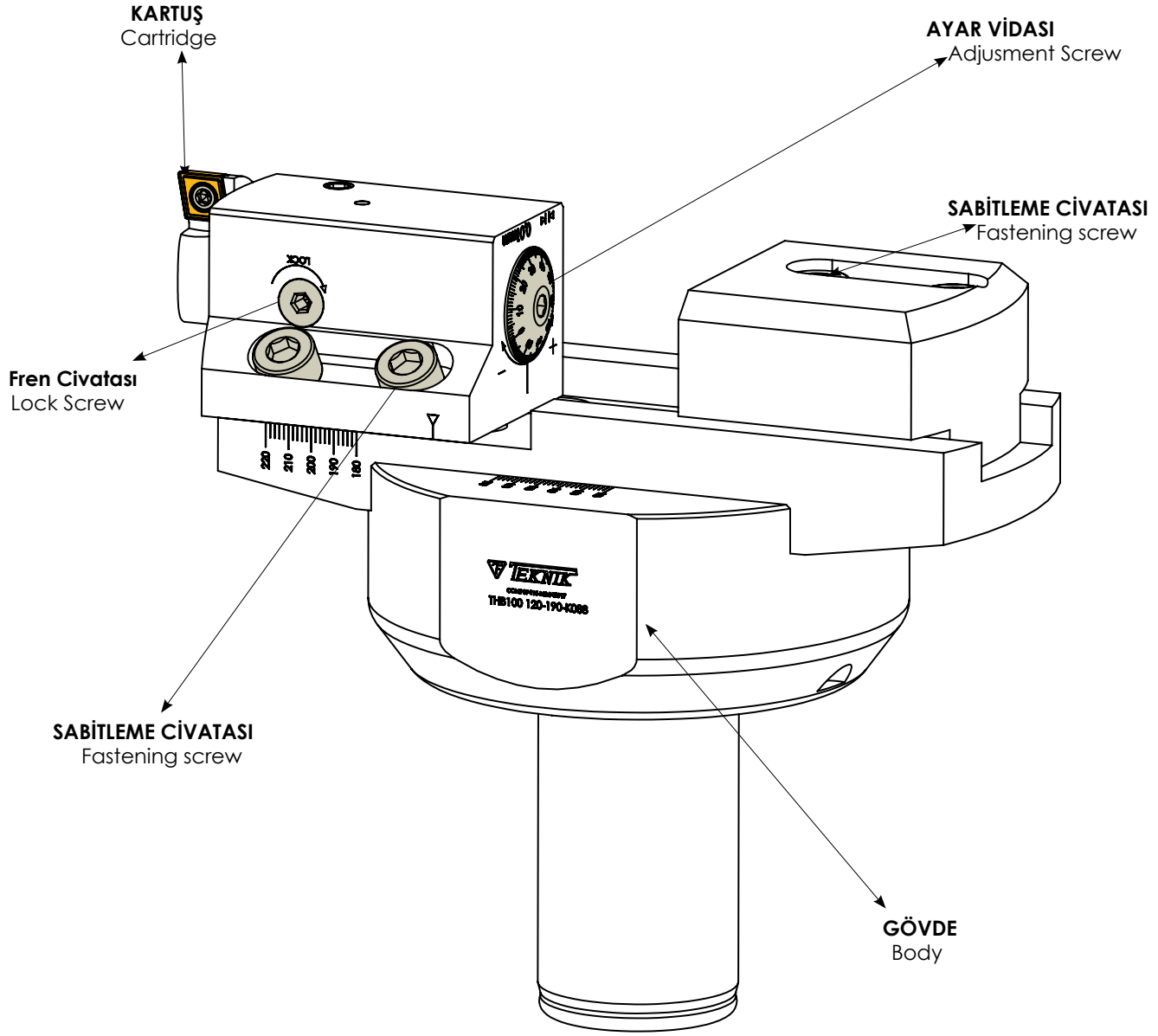

Dmin-Dmax	Kartuşlar Cartridges Kartusche	Kullanılan Uç Insert WSP	Sıkma Cıvatası Clamp Screw Torx-Schraube	Sabitleme Cıvatası Locking Screw Verriegelungs Schraube	Ayar Cıvatası Adjustment Screw Einstellschraube	Anahtar Torx Key Torx-Schlüssel
120-190	KR155	CC--09T3	TC067 M3,5x9	TC108-M8x30 SK42-M8x30	PC23-M8x46	T15
180-240	KR155	CC--09T3	TC067 M3,5x9	TC108-M8x30 SK42-M8x30	PC23-M8x46	T15
240-300	KR155	CC--09T3	TC067 M3,5x9	TC108-M8x30 SK42-M8x30	PC23-M8x46	T15

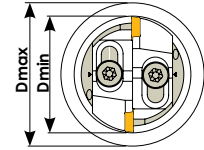
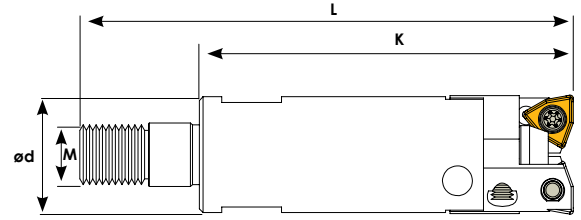

Sipariş Kodu Order Code Best.-Nr.	Stok/Stock/Lager	Ürün Kodu Product Code Produkt-Code	Ölçüler (mm) Dimensions(mm) Abmessungen (mm)						Kullanılan Uç Insert WSP
			Dmin	Dmax	M	K	L	ød	
TKB170	●	16-20 K050 M8 WC--03	16	20	M8	50	66	15,5	WC-- 0302
TKB172	●	19-23 K050 M10 CC--06	19	23	M10	50	70	17,5	CC -- 0602
TKB174	●	23-28 K050 M12 CC--06	23	28	M12	50	72	21,2	
TKB176	●	28-38 K050 M16 CC--09	28	38	M16	50	74,5	25,7	CC -- 09T3

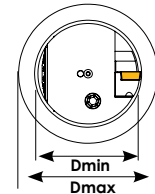
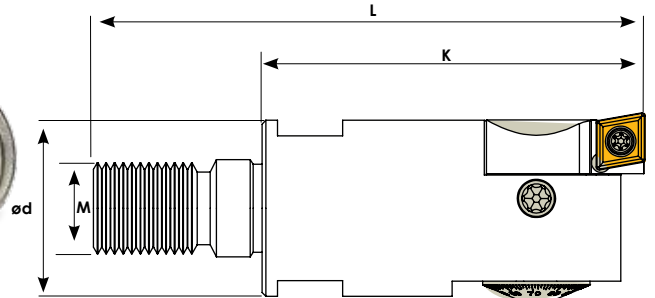

Sipariş Kodu Order Code Best.-Nr.	Stok/Stock/Lager	Ürün Kodu Product Code Produkt-Code	Ölçüler (mm) Dimensions(mm) Abmessungen (mm)						Kullanılan Uç Insert WSP	HASSASİYET Fine Fein
			Dmin	Dmax	M	K	L	ød		
THKB102	●	25-32 K050 M12 CC--06	25	32	M12	50	72	23	CC -- 0602	0,02
THKB104	●	32-40 K050 M16 CC--06	32	40	M16	50	74,3	29	CC -- 0602	0,01



Helis ve Disk Frezeler
Shoulder Milling & Disc Milling
Iğelfräser & Scheibenfräsen

H1 APKT 1604

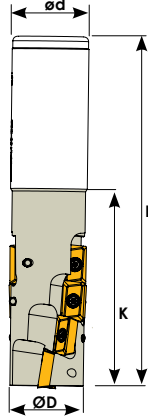

Ölçüler (mm) Dimensions(mm) Abmessungen (mm)		APKT 1604	
L	S		
16,40	4,76		

Sipariş Kodu Order Code Best.-Nr.	Stok/Stock/Lager	Ürün Kodu Product Code Produkt-Code	Ölçüler (mm) Dimensions(mm) Abmessungen (mm)					Kullanılan Uç Insert WSP	Sıkma Cıvatası Clamp Screw Torx-Schraube	Anahtar Torx Key Torx-Schlüssel
			ØD	Z	K	ød	L			
HF20	●	D32 Z06 K43 AP--16	32	6	43	32	125	AP-- 1604 KRLY	TC074 M4x10	T15
HF22	●	D40 Z09 K43 AP--16	40	9	43	32	125			
HF24	●	D32 Z08 K58 AP--16	32	8	58	32	150			
HF26	●	D40 Z12 K58 AP--16	40	12	58	32	150			
HF30	●	D32 Z08 K58 AP--16	32	8	58	32	200			
HF32	●	D40 Z12 K58 AP--16	40	12	58	32	200			

H2 APKT 1003

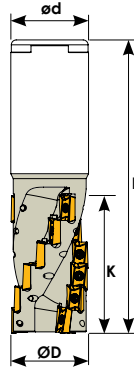

Ölçüler (mm) Dimensions(mm) Abmessungen (mm)		APKT 1003	
L	S		
10,05	3,52		

Sipariş Kodu Order Code Best.-Nr.	Stok/Stock/Lager	Ürün Kodu Product Code Produkt-Code	Ölçüler (mm) Dimensions(mm) Abmessungen (mm)					Kullanılan Uç Insert WSP	Sıkma Cıvatası Clamp Screw Torx-Schraube	Anahtar Torx Key Torx-Schlüssel
			ØD	Z	K	ød	L			
HF06	●	D20 Z06 K28 AP--10	20	6	28	20	120	AP-- 1003 KRLY	TC060 M2,5x5,5	T08
HF07	●	D25 Z08 K37 AP--10	25	8	37	25	120			
HF08	●	D32 Z15 K46 AP--10	32	15	46	32	120			
HF09	●	D40 Z18 K55 AP--10	40	18	55	32	125			
HF10	●	D20 Z06 K28 AP--10	20	6	28	20	150			
HF11	●	D25 Z08 K37 AP--10	25	8	37	25	150			
HF12	●	D32 Z15 K46 AP--10	32	15	46	32	150			
HF13	●	D40 Z18 K55 AP--10	40	18	55	32	150			
HF15	●	D20 Z06 K28 AP--10	20	6	28	20	200			
HF16	●	D25 Z08 K37 AP--10	25	8	37	25	200			
HF17	●	D32 Z15 K46 AP--10	32	15	46	32	200			
HF18	●	D40 Z18 K55 AP--10	40	18	55	32	200			

KRLY ucuna uygundur. / Compatible with KRLY insert. / Kompatible für KRLY WP

H3
APKT 1604

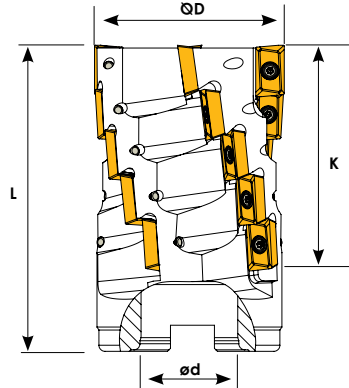

Ölçüler (mm) Dimensions (mm) Abmessungen (mm)		W 1604	
L	S		
16,4	4,76		

Sipariş Kodu Order Code Best.-Nr.	Stok/Stock/Lager	Ürün Kodu Product Code Produkt-Code	Ölçüler (mm) Dimensions (mm) Abmessungen (mm)					Kullanılan Uç Insert WSP	Sıkma Cıvatası Clamp Screw Torx-Schraube	Anahtar Torx Key Torx-Schlüssel
			ØD	Z	K	ød	L			
HF52	●	D63 Z20 K75 AP--16	63	20	75	32	100	AP-- 1604 KRLY	TC074 M4x10	
HF53	●	D80 Z25 K75 AP--16	80	25	75	32	100			
HF54	○	D100 Z30 K75 AP--16	100	30	75	40	100			

KRLY ucuna uygundur. / Compatible with KRLY insert. / Kompatible für KRLY WP

SCMT 09T3-1204

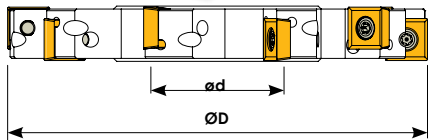

Ölçüler (mm) Dimensions (mm) Abmessungen (mm)		SCMT 09T3		SCMT 1204	
L	S				
9,52	3,97				
12,7	4,97				

Sipariş Kodu Order Code Best.-Nr.	Stok/Stock/Lager	Ürün Kodu Product Code Produkt-Code	Ölçüler (mm) Dimensions (mm) Abmessungen (mm)					Kullanılan Uç Insert WSP	Sıkma Cıvatası Clamp Screw Torx-Schraube	Anahtar Torx Key Torx-Schlüssel			
			ØD	A	Z	ød	Ap						
DF086	●	D080 A10 Z08 SC--09	80	10	8	27	17	SCMT 09T3 ISO	TC074-1 M4x10	T15			
DF092	●	D100 A10 Z08 SC--09	100	10	8	32	24						
DF100	●	D125 A10 Z10 SC--09	125	10	10	40	32						
DF108	●	D160 A10 Z12 SC--09	160	10	12	40	50						
DF116	●	D200 A10 Z14 SC--09	200	10	14	40	65						
DF088	●	D080 A12 Z08 SC--09	80	12	8	27	17						
DF094	●	D100 A12 Z08 SC--09	100	12	8	32	24						
DF102	●	D125 A12 Z10 SC--09	125	12	10	40	32						
DF110	●	D160 A12 Z12 SC--09	160	12	12	40	50						
DF118	●	D200 A12 Z14 SC--09	200	12	14	40	65						
DF090	●	D080 A16 Z08 SC--12	80	16	8	27	17				SCMT 1204 ISO	TC083 M5x12	T20
DF096	●	D100 A16 Z08 SC--12	100	16	8	32	24						
DF104	●	D125 A16 Z10 SC--12	125	16	10	40	32						
DF112	●	D160 A16 Z12 SC--12	160	16	12	40	50						
DF120	●	D200 A16 Z14 SC--12	200	16	14	40	65						
DF106	●	D125 A20 Z10 SC--12	125	20	10	40	32						
DF114	●	D160 A20 Z12 SC--12	160	20	12	40	50						

SCMT 09T3-1204 ISO'dur. / SCMT 09T3-1204 is ISO. / Kompatible für ISO WP

CCMT 0602-09T3-1204

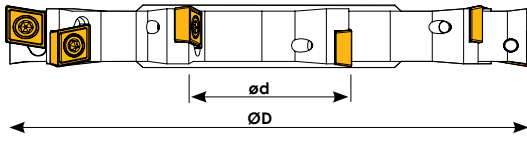

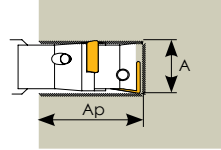
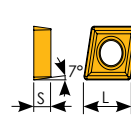
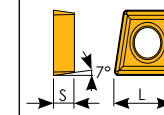
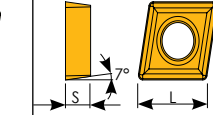
Ölçüler (mm) Dimensions (mm) Abmessungen (mm)				
L	S			
6,2	2,38			
9,4	3,97			
12,4	4,76			
		CCMT 0602	CCMT 09T3	CCMT 1204

Sipariş Kodu Order Code Best.-Nr.	Stok/Stock/Lager	Ürün Kodu Product Code Produkt-Code	Ölçüler (mm) Dimensions (mm) Abmessungen (mm)						Kullanılan Uç Insert WSP	Sıkma Cıvatası Clamp Screw Torx-Schraube	Anahtar Torx Key Torx-Schlüssel
			ØD	A	Z	ød	Ap				
DF150	●	D080 A08 Z10 CC--06	80	8	10	27	16	CCMT 0602 ISO	TC063 M2,5x7	T08	
DF160	●	D100 A08 Z12 CC--06	100	8	12	32	24				
DF170	●	D125 A08 Z14 CC--06	125	8	14	40	32				
DF182	●	D160 A08 Z16 CC--06	160	8	16	40	50				
DF194	●	D200 A08 Z18 CC--06	200	8	18	40	70				
DF152	●	D080 A10 Z10 CC--06	80	10	10	27	16				
DF162	●	D100 A10 Z12 CC--06	100	10	12	32	24				
DF172	●	D125 A10 Z14 CC--06	125	10	14	40	32				
DF184	●	D160 A10 Z16 CC--06	160	10	16	40	50				
DF196	●	D200 A10 Z18 CC--06	200	10	18	40	70				
DF154	●	D080 A12 Z08 CC--09	80	12	8	27	16	CCMT 09T3 ISO	TC067 M3,5x9	T15	
DF164	●	D100 A12 Z10 CC--09	100	12	10	32	24				
DF174	●	D125 A12 Z12 CC--09	125	12	12	40	32				
DF186	●	D160 A12 Z14 CC--09	160	12	14	40	50				
DF198	●	D200 A12 Z16 CC--09	200	12	16	40	70				
DF156	●	D080 A14 Z08 CC--09	80	14	8	27	16				
DF166	●	D100 A14 Z10 CC--09	100	14	10	32	24				
DF176	●	D125 A14 Z12 CC--09	125	14	12	40	32				
DF188	●	D160 A14 Z14 CC--09	160	14	14	40	50				
DF200	●	D200 A14 Z16 CC--09	200	14	16	40	70				
DF158	●	D080 A16 Z06 CC--12	80	16	6	27	16	CCMT 1204 ISO	TC083 M5x12	T20	
DF168	●	D100 A16 Z08 CC--12	100	16	8	32	24				
DF178	●	D125 A16 Z10 CC--12	125	16	10	40	32				
DF190	●	D160 A16 Z12 CC--12	160	16	12	40	50				
DF180	●	D125 A20 Z10 CC--12	125	20	10	40	32				
DF192	●	D160 A20 Z12 CC--12	160	20	12	40	50				



T Kanal Freze
T-Slot Milling Cutter
T- Nutenfräser

Arka Yüzey Frezeleme
Back Facing Milling Cutters

CCMT 0602-09T3-1204

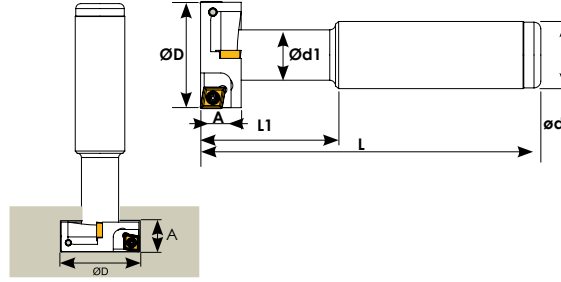

Ölçüler (mm) Dimensions (mm) Abmessungen (mm)		Uç Insert WSP
L	S	
6,2	2,38	CCMT 0602
9,4	3,97	CCMT 09T3
12,4	4,76	CCMT 1204

Sipariş Kodu Order Code Best.-Nr.	Stok/Stock/Lager	Ürün Kodu Product Code Produkt-Code	Ölçüler (mm) Dimensions (mm) Abmessungen (mm)							Kullanılan Uç Insert WSP	Sıkma Cıvatası Clamp Screw Torx-Schraube	Anahtar Torx Key Torx-Schlüssel
			ØD	A	Z	ød	ød1	L	L1			
TKÇ096	●	D17 A08 Z02 CC--06	17	8	2	16	10	100	28	CCMT 0602 ISO		
TKÇ098	●	D21 A09 Z02 CC--06	21	9	2	16	11	100	31,5			
TKÇ100	●	D25 A11 Z04 CC--06	25	11	4	20	15	100	32,5			
TKÇ102	●	D32 A12 Z04 CC--06	32	12	4	20	15	100	40	CCMT 09T3 ISO	TC067 M3,5x9	T15
TKÇ103	●	D32 A14 Z04 CC--09	32	14	4	25	16	100	33			
TKÇ104	●	D35 A15 Z04 CC--09	35	15	4	25	14	100	52			
TKÇ106	●	D40 A17 Z04 CC--09	40	17	4	25	20	110	50	CCMT 1204 ISO	TC083 M5x12	T20
TKÇ108	●	D50 A20 Z04 CC--12	50	20	4	32	26	110	50			
TKÇ120	●	D63 A09 Z08 CC--06	63	9	8	32	19,5	125	37	CCMT 0602 ISO	TC060 M2,5x5,5	T8
TKÇ122	●	D80 A09 Z10 CC--06	80	9	10	31,5	32	120	32			

CCMT 0602-09T3-1204 ISO'dur. / CCMT 0602-09T3-1204 is ISO. / Kompatible für ISO WP

S1 SPMG 05-06-07

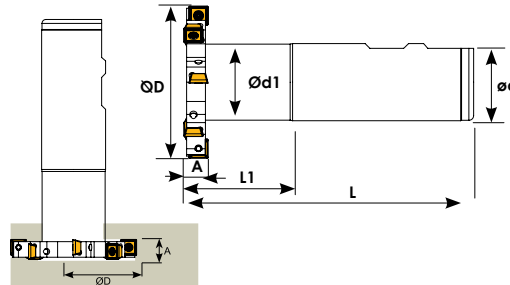

Ölçüler (mm) Dimensions (mm) Abmessungen (mm)		Uç Insert WSP
L	S	
5	2,38	SPMG 05
6	2,38	SPMG 06
7,94	3,97	SPMG 07

Sipariş Kodu Order Code Best.-Nr.	Stok/Stock/Lager	Ürün Kodu Product Code Produkt-Code	Ölçüler (mm) Dimensions (mm) Abmessungen (mm)							Kullanılan Uç Insert WSP	Sıkma Cıvatası Clamp Screw Torx-Schraube	Anahtar Torx Key Torx-Schlüssel
			ØD	A	Z	ød	ød1	L	L1			
TKÇ050	●	D50 A05 Z07 SP--05	50	5	7	32	31,5	120	45	SPMG 05 TGTC	TC058 M2x4,2	T6
TKÇ052	●	D63 A05 Z08 SP--05	63	5	8	32	31,5	120	45			
TKÇ054	●	D50 A06 Z07 SP--06	50	6	7	32	31,5	120	45			
TKÇ056	●	D63 A06 Z08 SP--06	63	6	8	32	31,5	120	45	SPMG 06 TGTC	TC059 M2,2x5	T7
TKÇ058	●	D80 A06 Z10 SP--06	80	6	10	32	31,5	120	45			
TKÇ060	●	D50 A08 Z06 SP--06	50	8	6	32	31,5	120	45			
TKÇ062	●	D63A08 Z08 SP--06	63	8	8	32	31,5	120	45	SPMG 07 TGTC	TC063 M2,5x7	T8
TKÇ064	●	D80 A08 Z10 SP--06	80	8	10	32	31,5	120	45			
TKÇ066	●	D50 A10 Z06 SP--07	50	10	6	32	31,5	120	45			
TKÇ068	●	D63 A10 Z08 SP--07	63	10	8	32	31,5	120	45			
TKÇ070	●	D80 A10 Z10 SP--07	80	10	10	32	31,5	120	45			

TGTCucuna uygundur. / Compatible with TGTCinsert. / Kompatible für TGTCWP

S2 DAIRE KANAL TAKIMI Round Milling Cutter

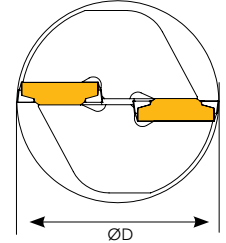
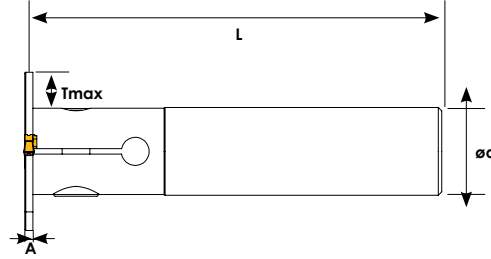

Sipariş Kodu Order Code Best.-Nr.	Stok/Stock/Lager	Ürün Kodu Product Code Produkt-Code	Ölçüler (mm) Dimensions (mm) Abmessungen (mm)						Kullanılan Uç Insert WSP	Sıkma Cıvatası Clamp Screw Torx-Schraube	Anahtar Torx Key Torx-Schlüssel
			ØD	A	Z	L	ød	Tmax			
TKÇ300	●	D50 A03 Z02 L-120	50	3	2	120	25	12,75	MGM 3C KRLY	M8	6 Allen
TKÇ301	●	D63 A03 Z02 L-120	63	3	2	120	25	19,25			
TKÇ302	●	D80 A03 Z02 L-120	80	3	2	120	32	24,25	MGM 4C KRLY	M8	6 Allen
TKÇ303	●	D50 A04 Z02 L-120	50	4	2	120	25	12,75			
TKÇ304	●	D63 A04 Z02 L-120	63	4	2	120	25	19,25	MGM 5C KRLY	M8	6 Allen
TKÇ305	●	D80 A04 Z02 L-120	80	4	2	120	32	24,25			
TKÇ306	●	D55 A05 Z02 L-120	55	5	2	120	25	15,25	MGM 5C KRLY	M8	6 Allen
TKÇ307	●	D63 A05 Z02 L-120	63	5	2	120	25	19,25			
TKÇ308	●	D80 A05 Z02 L-120	80	5	2	120	32	24,25			

KRLY ucuna uygundur. / Compatible with KRLY insert. / Kompatibel für KRLY WP

TCMT 1102 16T3 HAVŞA Chamfering end Milling

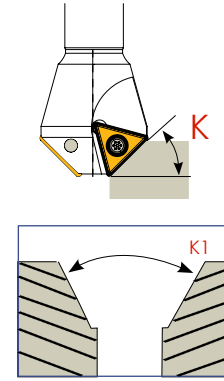
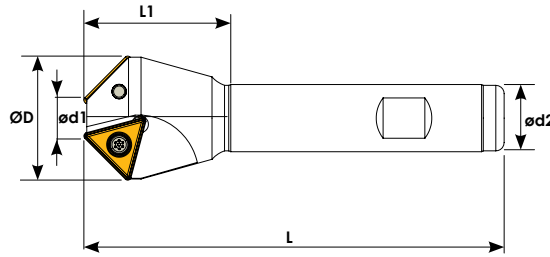

Sipariş Kodu Order Code Best.-Nr.	Stok/Stock/Lager	Ürün Kodu Product Code Produkt-Code	Ölçüler (mm) Dimensions (mm) Abmessungen (mm)								Kullanılan Uç Insert WSP	Sıkma Cıvatası Clamp Screw Torx-Schraube	Anahtar Torx Key Torx-Schlüssel
			ød1	ØD	Z	K	K1	ød2	L	L1			
S335	●	02-18 Z01 K30° TC--11	2	18	1	30°	60°	16	100	35	TCMT 1102 ISO	TC060 M2,5x5,5	T8
S334	●	04-16 Z01 K45° TC--11	4	16	1	45°	45°	16	100	35			
S339	●	10-31 Z02 K30° TC--16	10	31	2	30°	60°	16	100	35	TCMT 16T3 ISO	TC067 M3,5x9	T15
S337	●	06-20 Z01K30° TC--16	6	20	1	30°	60°	16	100	30			
S336	●	10-31 Z02 K45° TC--16	10	31	2	45°	45°	16	100	35			
S338	●	14-35 Z02 K45° TC--16	14	35	2	45°	45°	20	100	35			
S340	●	22-43 Z03 K45° TC--16	22	43	3	45°	45°	25	100	35			
S341	●	06-26 Z01 K45° TC--16	6	26	1	45°	45°	20	100	27,45			
S342	●	32-53 Z03 K45° TC--16	32	53	3	45°	45°	25	100	32,5			
S343	●	24-39 Z02 K60° TC--16	24	39	2	60°	30°	20	100	29,5			
S345	●	10-34 Z02 K60° TC--16	10	34	2	60°	30°	20	100	34			

TCMT 1102-16T3 ISO'dur. / TCMT 11T3-16T3 is ISO. / Kompatibel für ISO WP

Arka Yüzey Frezeleme Back Facing Milling Cutters

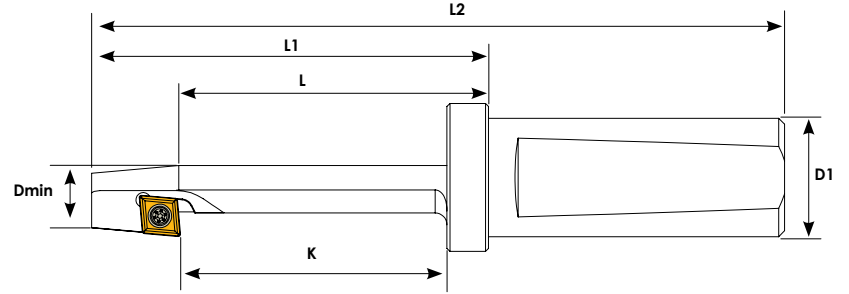

Sipariş Kodu Order Code Best.-Nr.	Stok/Stock/Lager	Ürün Kodu Product Code Produkt-Code	Ölçüler (mm) Dimensions(mm) Abmessungen (mm)							Kullanılan Uç Insert WSP	Sıkma Civatası Clamp Screw Torx-Schraube	Anahtar Torx Key Torx-Schlüssel
			ØD	Dmin	K	L	L1	L2	D1			
C100	●	D18-K40 CC--06	18	10	40	47	60	110	20	CCMT 060204 ISO	TC060 M2,5x5	T08
C102	●	D20-K45 CC--06	20	12	45	52	67	117	20			
C104	●	D26-K60 CC--06	26	17	60	67	82	132	20			
C106	●	D33-K75 CC--09	33	21	75	82	102	152	20	CCMT 09T304 ISO	TC067 M3,5x9	T15

CCMT 0602-09T3-1204 ISO'dur. / CCMT 0602-09T3-1204 is ISO. / Kompatible für ISO WP

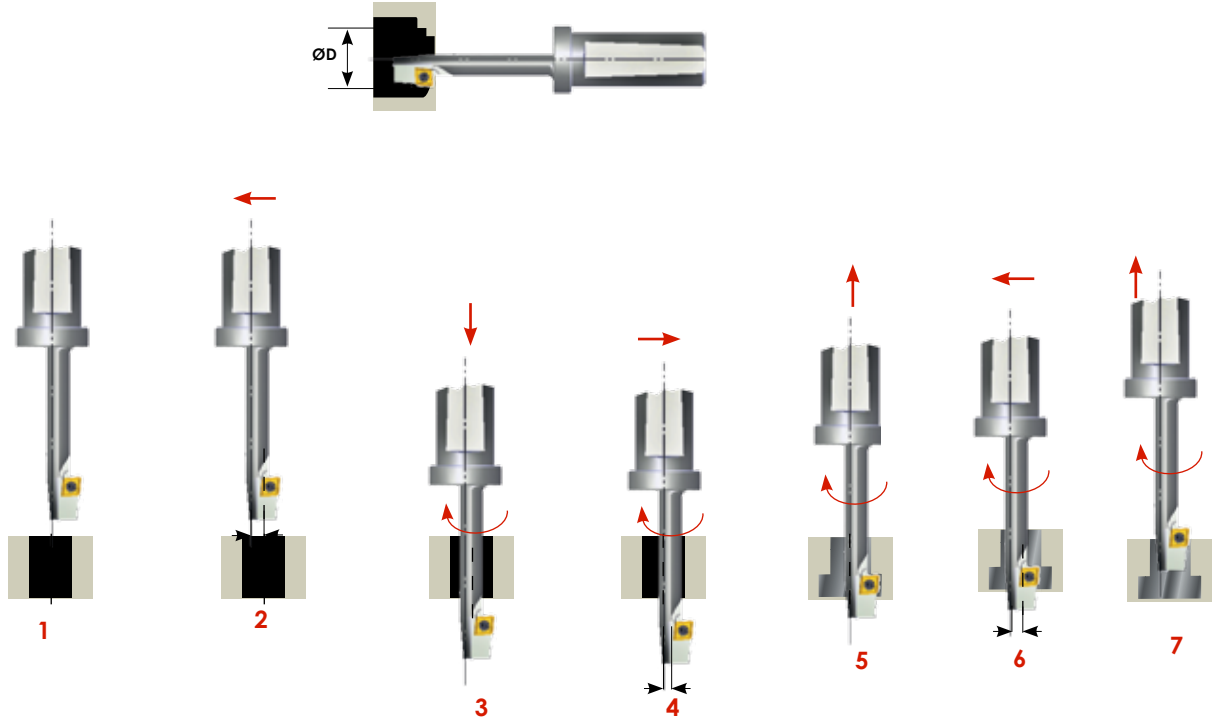

S3
RHKW 1003

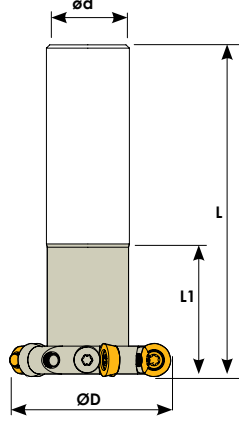

Ölçüler (mm) Dimensions(mm) Abmessungen (mm)		RHKW 1003	
d	S		
10	3,80		

Sipariş Kodu Order Code Best.-Nr.	Stok/Stock/Lager	Ürün Kodu Product Code Produkt-Code	Ölçüler (mm) Dimensions(mm) Abmessungen (mm)					Kullanılan Uç Insert WSP	Sıkma Cıvatası Clamp Screw Torx-Schraube	Baskı Cıvatası Locking Screw Verriegelungs Schraube	Anahtar Torx Key Torx-Schlüssel
			ØD	Z	L	ød	L1				
TKÇ200	●	D40 d20 Z04 L100 RH--10	40	4	100	20	40				
TKÇ202	●	D50 d25 Z05 L120 RH--10	50	5	120	25	40	RHKW 1003 INGRSLL	TC074 M4x10	TC040 M3,5	T15

INGRSLL ucuna uygundur. / Compatible with INGRSLL insert. / Kompatible für INGRSLL WP

S4
45° SPMG 0904

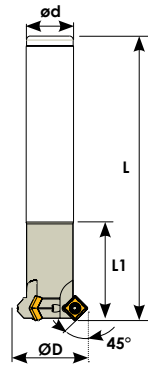

Ölçüler (mm) Dimensions(mm) Abmessungen (mm)		SPMG 0904	
L	S		
9,8	4,3		

Sipariş Kodu Order Code Best.-Nr.	Stok/Stock/Lager	Ürün Kodu Product Code Produkt-Code	Ölçüler (mm) Dimensions(mm) Abmessungen (mm)					Kullanılan Uç Insert WSP	Sıkma Cıvatası Clamp Screw Torx-Schraube	Anahtar Torx Key Torx-Schlüssel
			ØD	Z	L	ød	L1			
S060	●	D32 d25 Z02 L150 SP--09	32	2	150	25	30			
S062	●	D40 d25 Z03 L150 SP--09	40	3	150	25	50	SPMG 0904 TGTC	TC067 M3,5x9	T15

TGTCucuna uygundur. / Compatible with TGTCinsert. / Kompatible für TGTCWP

55° DCMT 11T3-35° VBMT 1604

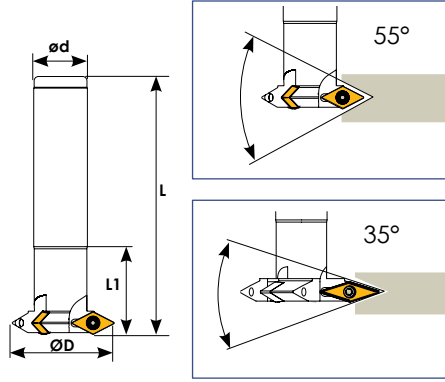

Ölçüler (mm) Dimensions (mm) Abmessungen (mm)		DCMT 11T3	
L	S		
11,3	3,97		
15,3	4,76	VBMT 1604	

Sipariş Kodu Order Code Best.-Nr.	Stok/Stock/Lager	Ürün Kodu Product Code Produkt-Code	Ölçüler (mm) Dimensions (mm) Abmessungen (mm)					Kullanılan Uç Insert WSP	Sıkma Civatası Clamp Screw Torx-Schraube	Anahtar Torx Key Torx-Schlüssel
			ØD	Z	L	ød	L1			
S070	●	D50 d25 Z03 L120-DC--11	50	3	120	25	40	DCMT 11T3	TC067	T15
S072	●	D63 d25 Z04 L120-DC--11	63	4	120	25	40	ISO	M3.5X9	T15
S073	●	D75 d25 Z03 L130-VB--16	75	3	130	25	40	VBMT 1604 ISO	TC074 M4x10	T15

DCMT 11T3 ISO'dur./ DCMT 11T3 is ISO. / Kompatible für ISO WP

60° DCMT 11T3

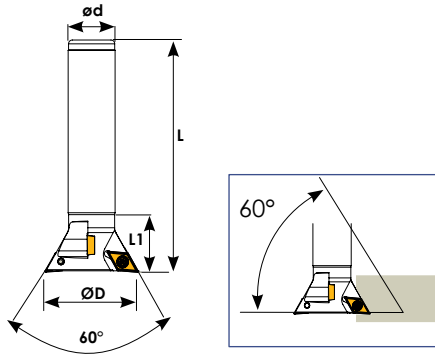

Ölçüler (mm) Dimensions (mm) Abmessungen (mm)		DCMT 11T3	
L	S		
11,3	3,97		

Sipariş Kodu Order Code Best.-Nr.	Stok/Stock/Lager	Ürün Kodu Product Code Produkt-Code	Ölçüler (mm) Dimensions (mm) Abmessungen (mm)					Kullanılan Uç Insert WSP	Sıkma Civatası Clamp Screw Torx-Schraube	Anahtar Torx Key Torx-Schlüssel
			ØD	Z	L	ød	L1			
TKÇ 250	●	D050 d25 Z04 L120 DC--11	50	4	120	25	30	DCMT 11T3	TC067	T15
								ISO	M3.5X9	T15

● Stokta/ In Stock / Lager ○ Sınırlı Stok / Limited Stock / Begrenzte Lagerhaltung

DCMT 11T3 ISO'dur./ DCMT 11T3 is ISO. / Kompatible für ISO WP

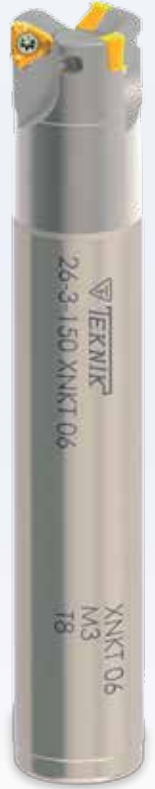

Saplı Tarama
End Mill
Schafffräser

S5
APKT 1003

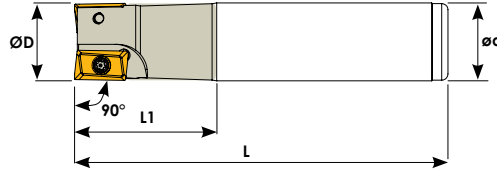

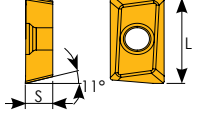
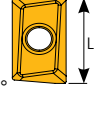
Ölçüler (mm) Dimensions (mm) Abmessungen (mm)		AP-- 1003	
L	S		
10	3,52		

Sipariş Kodu Order Code Best.-Nr.	Stok/Stok/Lager	Ürün Kodu Product Code Produkt-Code	Ölçüler (mm) Dimensions (mm) Abmessungen (mm)					Sıkma Civatası Clamp Screw Torx-Schraube	Kullanılan Uç Insert WSP	Anahtar Torx Key Torx-Schlüssel
			ØD	Z	L	ød	L1			
S136	●	D12 d12 Z01 L100 AP--10	12	1	100	12	27	TC060 M2,5x5,5	AP-- 1003 KRLY	T8
S138	●	D14 d14 Z01 L100 AP--10	14	1	100	14	30			
S140	●	D16 d16 Z02 L100 AP--10	16	2	100	16	30			
S142	●	D18 d16 Z02 L100 AP--10	18	2	100	16	30			
S144	●	D20 d20 Z03 L100 AP--10	20	3	100	20	30			
S146	●	D22 d20 Z03 L100 AP--10	22	3	100	20	30			
S148	●	D25 d25 Z03 L100 AP--10	25	3	100	25	35			
S150	●	D30 d25 Z04 L100 AP--10	30	4	100	25	40			
S152	●	D32 d25 Z04 L100 AP--10	32	4	100	25	35			
S154	●	D35 d25 Z04 L100 AP--10	35	4	100	25	30			
S156	●	D40 d25 Z05 L100 AP--10	40	5	100	25	30			
S158	●	D12 d12 Z01 L120 AP--10	12	1	120	12	27			
S160	●	D14 d14 Z01 L120 AP--10	14	1	120	14	30			
S162	●	D16 d16 Z02 L120 AP--10	16	2	120	16	40			
S164	●	D18 d16 Z02 L120 AP--10	18	2	120	16	45			
S166	●	D20 d20 Z03 L120 AP--10	20	3	120	20	40			
S168	●	D22 d20 Z03 L120 AP--10	22	3	120	20	40			
S169	●	D25 d25 Z03 L120 AP--10	25	3	120	25	40			
S170	●	D30 d25 Z04 L120 AP--10	30	4	120	25	40			
S171-1	●	D32 d25 Z04 L120 AP--10	32	4	120	25	40			
S171	●	D35 d25 Z04 L120 AP--10	35	4	120	25	40			
S172	●	D40 d25 Z05 L120 AP--10	40	5	120	25	40			

KRLY ucuna uygundur. / Compatible with KRLY insert. / Kompatible für KRLY WP

S7
APKT 1003

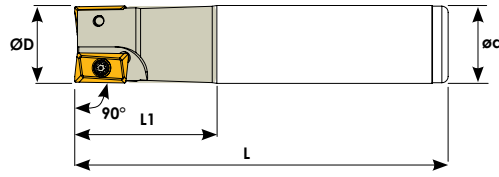

Ölçüler (mm) Dimensions (mm) Abmessungen (mm)		AP-- 1003	
L	S		
10	3,52		

Sipariş Kodu Order Code Best.-Nr.	Stok/Stock/Lager	Ürün Kodu Product Code Produkt-Code	Ölçüler (mm) Dimensions (mm) Abmessungen (mm)					Sıkma Civatası Clamp Screw Torx-Schraube	Kullanılan Uç Insert WSP	Anahtar Torx Key Torx-Schlüssel
			ØD	Z	L	ød	L1			
S173	●	D16 d16 Z02 L150 AP--10	16	2	150	16	50	 TC060 M2,5x5,5	 AP-- 1003 KRLY	 T8
S174	●	D18 d16 Z02 L150 AP--10	18	2	150	16	50			
S176	●	D20 d20 Z03 L150 AP--10	20	3	150	20	60			
S178	●	D22 d20 Z03 L150 AP--10	22	3	150	20	60			
S180	●	D25 d25 Z03 L150 AP--10	25	3	150	25	60			
S180-1	●	D30 d25 Z04 L150 AP--10	30	4	150	25	60			
S181	●	D32 d32 Z04 L150 AP--10	32	4	150	32	45			
S182	●	D16 d16 Z02 L200 AP--10	16	2	200	16	60			
S184	●	D18 d16 Z02 L200 AP--10	18	2	200	16	60			
S186	●	D20 d20 Z03 L200 AP--10	20	3	200	20	70			
S187	●	D22 d20 Z03 L200 AP--10	22	3	200	20	70			
S188	●	D25 d25 Z03 L200 AP--10	25	3	200	25	60			
S188-1	●	D30 d25 Z04 L200 AP--10	30	4	200	25	50			
S189	●	D32 d32 Z04 L200 AP--10	32	4	200	32	60			
S190	●	D16 d16 Z02 L250 AP--10	16	2	250	16	70			
S192	●	D20 d20 Z03 L250 AP--10	20	3	250	20	70			
S194	●	D25 d25 Z03 L250 AP--10	25	3	250	25	70			

KRLY ucuna uygundur. / Compatible with KRLY insert. / Kompatible für KRLY WP

S8
APKT 1604

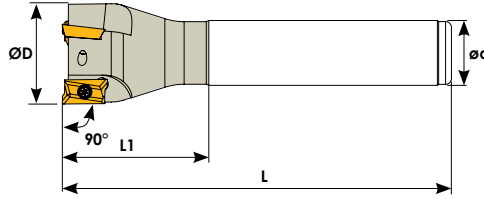

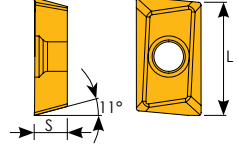
Ölçüler (mm) Dimensions(mm) Abmessungen (mm)		AP-- 1604	
L	S		
16,40	4,76		

Sipariş Kodu Order Code Best.-Nr.	Stok/Stock/Lager	Ürün Kodu Product Code Produkt-Code	Ölçüler (mm) Dimensions(mm) Abmessungen (mm)					Sıkma Cıvatası Clamp Screw Torx-Schraube	Kullanılan Uç Insert WSP	Anahtar Torx Key Torx-Schlüssel
			ØD	Z	L	ød	L1			
S256	●	D25 d25 Z02 L120 AP--16	25	2	120	25	45	TC074 M4x10	AP-- 1604 KRLY	T15
S258	●	D30 d25 Z03 L120 AP--16	30	3	120	25	45			
S260	●	D32 d25 Z03 L120 AP--16	32	3	120	25	45			
S262	●	D35 d25 Z03 L120 AP--16	35	3	120	25	45			
S264	●	D40 d25 Z04 L120 AP--16	40	4	120	25	45			
S266	●	D25 d25 Z02 L150 AP--16	25	2	150	25	55			
S268	●	D30 d25 Z03 L150 AP--16	30	3	150	25	55			
S270	●	D32 d32 Z03 L150 AP--16	32	3	150	32	55			
S272	●	D35 d32 Z03 L150 AP--16	35	3	150	32	55			
S274	●	D40 d25 Z04 L150 AP--16	40	4	150	32	55			
S276	●	D25 d25 Z02 L200 AP--16	25	2	200	25	65			
S278	●	D30 d25 Z03 L200 AP--16	30	3	200	25	55			
S280	●	D32 d32 Z03 L200 AP--16	32	3	200	32	55			
S282	●	D35 d32 Z03 L200 AP--16	35	3	200	32	55			
S283	●	D40 d32 Z04 L200 AP--16	40	4	200	32	55			
S432	●	D25 d25 Z02 L250 AP--16	25	2	250	25	70			
S434	●	D30 d25 Z03 L250 AP--16	30	3	250	25	55			
S436	●	D32 d32 Z03 L250 AP--16	32	3	250	32	60			
S438	●	D35 d32 Z03 L250 AP--16	35	3	250	32	65			
S440	●	D40 d32 Z04 L250 AP--16	40	4	250	32	60			
S442	●	D25 d25 Z02 L300 AP--16	25	2	300	25	70			
S444	●	D30 d25 Z03 L300 AP--16	30	3	300	25	60			
S446	●	D32 d32 Z03 L300 AP--16	32	3	300	32	70			
S448	●	D35 d32 Z03 L300 AP--16	35	3	300	32	65			
S450	●	D40 d32 Z04 L300 AP--16	40	4	300	32	70			
S453	●	D32 d32 Z03 L350 AP--16	32	3	350	32	80			
S454	●	D35 d32 Z03 L350 AP--16	35	3	350	32	65			
S456	●	D40 d32 Z04 L350 AP--16	40	4	350	32	55			

KRLY ucuna uygundur. / Compatible with KRLY insert. / Kompatible für KRLY WP

S9
APMT 0602

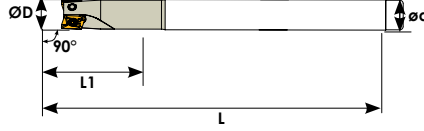

Ölçüler (mm) Dimensions(mm) Abmessungen (mm)	
L	S
6	2,6

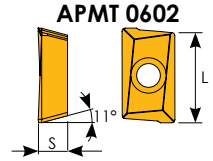

Sipariş Kodu Order Code Best.-Nr.	Stok/Stock/Lager	Ürün Kodu Product Code Produkt-Code	Ölçüler (mm) Dimensions(mm) Abmessungen (mm)					Kullanılan Uç Insert WSP	Sıkma Cıvatası Clamp Screw Torx-Schraube	Anahtar Torx Key Torx-Schlüssel
			ØD	Z	L	ød	L1			
S009	●	D10 d10 Z02 L120 AP--06	10	2	120	10	30	APMT 06 KRLY	TC058 M2x4,2	T6
S011	●	D12 d12 Z02 L120 AP--06	12	2	120	12	30			

KRLY ucuna uygundur. / Compatible with KRLY insert. / Kompatible für KRLY WP

S10
APMT 11T3

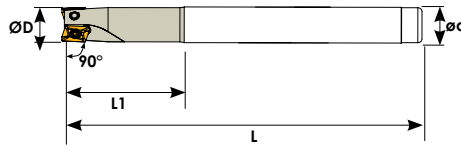

Ölçüler (mm) Dimensions(mm) Abmessungen (mm)	
L	S
11	3,97

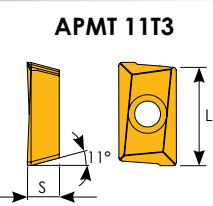

Sipariş Kodu Order Code Best.-Nr.	Stok/Stock/Lager	Ürün Kodu Product Code Produkt-Code	Ölçüler (mm) Dimensions(mm) Abmessungen (mm)					Kullanılan Uç Insert WSP	Sıkma Cıvatası Clamp Screw Torx-Schraube	Anahtar Torx Key Torx-Schlüssel
			ØD	Z	L	ød	L1			
S222	●	D10 d10 Z01 L085 AP--11	10	1	85	10	20	APMT 11T3 KRLY	TC060 N2,5x5,5	T8
S224	●	D12 d16 Z01 L085 AP--11	12	1	85	16	25			
S226	●	D14 d16 Z01 L090 AP--11	14	1	90	16	25			
S228	●	D16 d16 Z02 L090 AP--11	16	2	90	16	25			
S230	●	D16 d16 Z02 L180 AP--11	16	2	180	16	30			
S232	●	D20 d20 Z02 L100 AP--11	20	2	100	20	30			
S234	●	D20 d20 Z02 L210 AP--11	20	2	210	20	30			
S236	●	D25 d25 Z03 L115 AP--11	25	3	115	25	35			
S238	●	D25 d25 Z03 L180 AP--11	25	3	180	25	40			
S240	●	D32 d32 Z04 L125 AP--11	32	4	125	32	40			
S242	●	D32 d32 Z04 L180 AP--11	32	4	180	32	50			

S11
APMT 1604

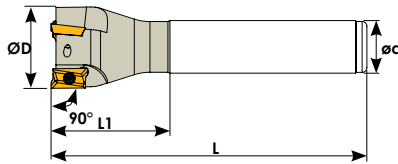
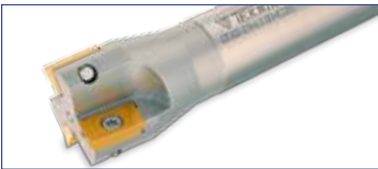

Ölçüler (mm) Dimensions(mm) Abmessungen (mm)	
L	S
16,40	4,76

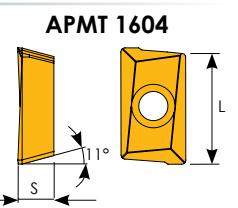



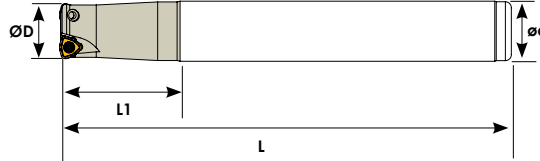

Sipariş Kodu Order Code Best.-Nr.	Stok/Stock/Lager	Ürün Kodu Product Code Produkt-Code	Ölçüler (mm) Dimensions(mm) Abmessungen (mm)					Kullanılan Uç Insert WSP	Sıkma Cıvatası Clamp Screw Torx-Schraube	Anahtar Torx Key Torx-Schlüssel
			ØD	Z	L	ød	L1			
S244	●	D25 d25 Z02 L120 AP--16	25	2	120	25	45	APMT 1604 KRLY	TC074 M4x10	T15
S245	●	D25 d25 Z02 L150 AP--16	25	2	150	25	55			
S247	●	D32 d25 Z03 L120 AP--16	32	3	120	25	45			
S248	●	D32 d32 Z03 L150 AP--16	32	3	150	32	55			
S250	●	D40 d32 Z04 L120 AP--16	40	4	120	32	45			
S251	●	D40 d32 Z04 L150 AP--16	40	4	150	32	55			

KRLY ucuna uygundur. / Compatible with KRLY insert. / Kompatible für KRLY WP

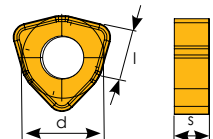
S12 WNMX 0603







Ölçüler (mm) Dimensions (mm) Abmessungen (mm)			WNMX 0603	
D	I	S		
6,35	4,28	3,18		

Sipariş Kodu Order Code Best.-Nr.	Stok/Stock/Lager	Ürün Kodu Product Code Produkt-Code	Ölçüler (mm) Dimensions (mm) Abmessungen (mm)					Kullanılan Uç Insert WSP	Sıkma Civatası Clamp Screw Torx-Schraube	Anahtar Torx Key Torx-Schlüssel
			ØD	Z	L	ød	L1			
S898	●	D16 d16 Z02 L150 WN--06	16	2	150	16	40	 WNMX 0603 KRLY	 TC060 M2,5x5,5	 T8
S899	●	D20 d20 Z02 L150 WN--06	20	2	150	20	40			
S903	●	D17 d16 Z02 L150 WN--06	17	2	150	16	40			
S904	●	D21 d20 Z02 L150 WN--06	21	2	150	20	40			
S905	●	D25 d25 Z03 L150 WN--06	25	3	150	25	60			
S906	●	D26 d25 Z04 L150 WN--06	26	4	150	25	60			

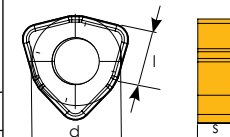
S13 WNMX 09T3



Ölçüler (mm) Dimensions (mm) Abmessungen (mm)			WNMX 09T3	
D	I	S		
9,52	6,8	3,97		

Sipariş Kodu Order Code Best.-Nr.	Stok/Stock/Lager	Ürün Kodu Product Code Produkt-Code	Ölçüler (mm) Dimensions (mm) Abmessungen (mm)					Kullanılan Uç Insert WSP	Sıkma Civatası Clamp Screw Torx-Schraube	Anahtar Torx Key Torx-Schlüssel
			ØD	Z	L	ød	L1			
S802	●	D25 d25 Z02 L150 WN--09	25	2	150	25	60	 WNMX 09T3 KRLY	 TC065 M3x7	 T8
S804	●	D30 d25 Z03 L150 WN--09	30	3	150	25	60			

KRLY ucuna uygundur. / Compatible with KRLY insert. / Kompatible für KRLY WP

S14 LNMX 1510

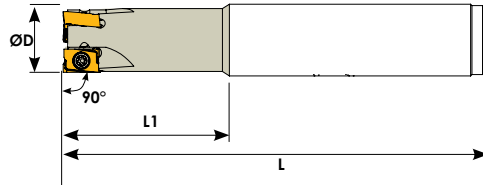

Ölçüler (mm) Dimensions (mm) Abmessungen (mm)			LNMX 1510	
L	S	A		
15	10	10		

Sipariş Kodu Order Code Best.-Nr.	Stok/Stock/Lager	Ürün Kodu Product Code Produkt-Code	Ölçüler (mm) Dimensions (mm) Abmessungen (mm)					Kullanılan Uç Insert WSP	Sıkma Cıvatası Clamp Screw Torx-Schraube	Anahtar Torx Key Torx-Schlüssel
			ØD	Z	L	ød	L1			
S361	●	D32 d32 Z02 L150 LN--15	32	2	150	32	50			
S362	●	D40 d32 Z03 L150 LN--15	40	3	150	32	50			

S15 LNMX 1006

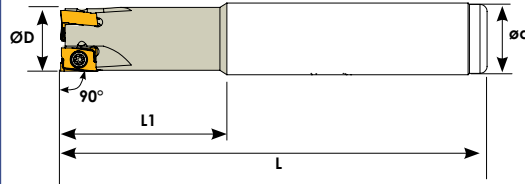

Ölçüler (mm) Dimensions (mm) Abmessungen (mm)			LNMX 1006	
L	S	A		
10	6,6 6,35			

Sipariş Kodu Order Code Best.-Nr.	Stok/Stock/Lager	Ürün Kodu Product Code Produkt-Code	Ölçüler (mm) Dimensions (mm) Abmessungen (mm)					Kullanılan Uç Insert WSP	Sıkma Cıvatası Clamp Screw Torx-Schraube	Anahtar Torx Key Torx-Schlüssel
			ØD	Z	L	ød	L1			
LN097	●	D22 d20 Z02 L100 LN--10	22	2	100	20	-			
LN098	●	D24 d25 Z03 L100 LN--10	24	3	100	25	15			
LN099	●	D20 d20 Z02 L120 LN--10	20	2	120	20	25			
LN100	●	D20 d20 Z03 L120 LN--10	20	3	120	20	25			
LN102	●	D25 d25 Z03 L120 LN--10	25	3	120	25	40			

KRLY ucuna uygundur. / Compatible with KRLY insert. / Kompatible für KRLY WP

S16
XNKT 0604



Ölçüler (mm) Dimensions(mm) Abmessungen (mm)			XNKT 0604	
d	l	s		
6,5	5,7	4		

Sipariş Kodu Order Code Best.-Nr.	Stok/Stock/Lager	Ürün Kodu Product Code Produkt-Code	Ölçüler (mm) Dimensions(mm) Abmessungen (mm)					Kullanılan Uç Insert WSP	Sıkma Civatası Clamp Screw Torx-Schraube	Anahtar Torx Key Torx-Schlüssel
			ØD	Z	L	ød	L1			
S834	●	D20 d20 Z02 L150 XN--06	20	2	150	20	40			
S836	●	D21 d20 Z02 L150 XN--06	21	2	150	20	40			
S838	●	D25 d25 Z03 L150 XN--06	25	3	150	25	40			
S840	●	D26 d25 Z03 L150 XN--06	26	3	150	25	40			
S841	●	D32 d32 Z04 L150 XN--06	32	4	150	32	40			

S17
F75° APKT 1003

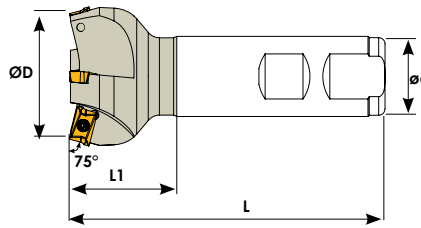

Ölçüler (mm) Dimensions(mm) Abmessungen (mm)		AP-- 1003	
L	S		
10	3,52		

Sipariş Kodu Order Code Best.-Nr.	Stok/Stock/Lager	Ürün Kodu Product Code Produkt-Code	Ölçüler (mm) Dimensions(mm) Abmessungen (mm)					Kullanılan Uç Insert WSP	Sıkma Civatası Clamp Screw Torx-Schraube	Anahtar Torx Key Torx-Schlüssel
			ØD	Z	L	ød	L1			
S344	●	D32 d25 Z03 L100 AP--10	32	3	100	25	35			
S346	●	D40 d25 Z04 L100 AP--10	40	4	100	25	35			
S348	●	D45 d25 Z04 L100 AP--10	45	4	100	25	35			
S350	●	D50 d25 Z05 L100 AP--10	50	5	100	25	35			

KRLY ucuna uygundur. / Compatible with KRLY insert. / Kompatible für KRLY WP

**S18
ADMX 0702**

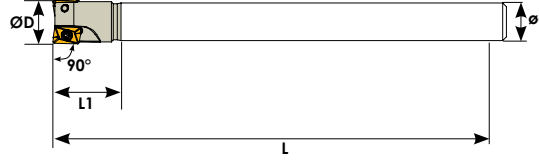

Ölçüler (mm) Dimensions (mm) Abmessungen (mm)		ADMX 0702	
L	S		
7,28	2,48		

Sipariş Kodu Order Code Best.-Nr.	Stok/Stock/Lager	Ürün Kodu Product Code Produkt-Code	Ölçüler (mm) Dimensions (mm) Abmessungen (mm)					Kullanılan Uç Insert WSP	Sıkma Civatası Clamp Screw Torx-Schraube	Anahtar Torx Key Torx-Schlüssel
			ØD	Z	L	ød	L1			
S751	●	D10 d10 Z02 L080 AD--07	10	2	80	10	16	ADMX 0702 PRMT	TC058 M2x4,2	T6
S754	●	D12 d12 Z03 L090 AD--07	12	3	90	12	16			
S755	●	D12 d12 Z03 L120 AD--07	12	3	120	12	17			
S756	●	D14 d12 Z03 L090 AD--07	14	3	90	12	16			
S757	●	D14 d12 Z03 L140 AD--07	14	3	140	12	18			
S758	●	D16 d16 Z03 L090 AD--07	16	3	90	16	16			
S759	●	D16 d16 Z03 L160 AD--07	16	3	160	16	18			
S760	●	D20 d20 Z04 L125 AD--07	20	4	125	20	17			
S761	●	D20 d20 Z05 L125 AD--07	20	5	125	20	17			

PRMT ucuna uygundur. / Compatible with PRMT insert. / Kompatible für PRMT WP

**S19
LNGU 15T6**

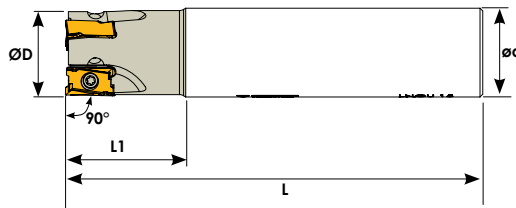

Ölçüler (mm) Dimensions (mm) Abmessungen (mm)			LNGU 15T6	
L	S	A		
17	6,96	10		

Sipariş Kodu Order Code Best.-Nr.	Stok/Stock/Lager	Ürün Kodu Product Code Produkt-Code	Ölçüler (mm) Dimensions (mm) Abmessungen (mm)					Kullanılan Uç Insert WSP	Sıkma Civatası Clamp Screw Torx-Schraube	Anahtar Torx Key Torx-Schlüssel
			ØD	Z	L	ød	L1			
S950	●	D25 d25 Z02 L150 LN--15	25	2	150	25	45	LNGU 15T6 KNNMTL	TC075 M4x11	T15
S951	●	D32 d32 Z03 L150 LN--15	32	3	150	32	45			

KNNMTL ucuna uygundur. / Compatible with KNNMTL insert. / Kompatible für KNNMTL WP

S20

XOMX 0602-0903-1204

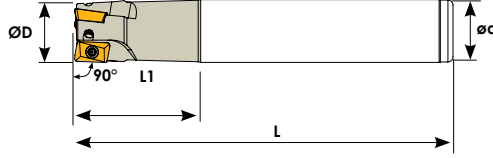

Ölçüler (mm) Dimensions (mm) Abmessungen (mm)		XOMX 1204	
L	S		
12	5,06		

Sipariş Kodu Order Code Best.-Nr.	Stok/Stock/Lager	Ürün Kodu Product Code Produkt-Code	Ölçüler (mm) Dimensions (mm) Abmessungen (mm)					Sıkma Cıvatası Clamp Screw Torx-Schraube	Kullanılan Uç Insert WSP	Anahtar Torx Key Torx-Schlüssel
			ØD	Z	L	ød	L1			
S623	●	D10 d10 Z02 L120 XO--06	10	2	120	10	40	TC051	XOMX 0602 SCO	T6
S625	●	D12 d12 Z02 L120 XO--06	12	2	120	12	30	M1,8x4		
S627	●	D16 d16 Z02 L120 XO--09	16	2	120	16	45	TC060 M2,5x5,5	XOMX 0903 SCO	T8
S626	●	D20 d20 Z03 L120 XO--09	20	3	120	20	40	TC063 M2,5x7		
S629	●	D16 d16 Z02 L150 XO--09	16	2	150	16	45	TC060 M2,5x5,5		
S628	●	D20 d20 Z03 L150 XO--09	20	3	150	20	55	TC063 M2,5x7	XOMX 1204 SCO	T10
S638	●	D20 d20 Z02 L120 XO--12	20	2	120	20	45	TC069 M3,5x8,5		
S640	●	D20 d20 Z02 L150 XO--12	20	2	150	20	55			
S641	●	D20 d20 Z02 L200 XO--12	20	2	200	20	60			
S636	●	D20 d20 Z03 L200 XO--12	20	3	200	20	55			
S642	●	D25 d25 Z03 L120 XO--12	25	3	120	25	45			
S632	●	D25 d25 Z03 L150 XO--12	25	3	150	25	55			
S643	●	D25 d25 Z03 L150 XO--12	25	3	150	25	55			
S644	●	D25 d25 Z03 L200 XO--12	25	3	200	25	60			
S645	●	D25 d25 Z03 L250 XO--12	25	3	250	25	70			
S647	●	D32 d32 Z04 L120 XO--12	32	4	120	25	45			
S648	●	D32 d32 Z04 L150 XO--12	32	4	150	32	55			
S650	●	D40 d32 Z04 L150 XO--12	40	4	150	32	45			

S21

LOEX 0804

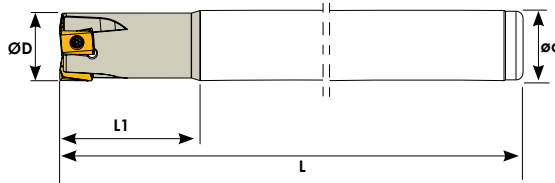

Ölçüler (mm) Dimensions (mm) Abmessungen (mm)		XOMX 0804	
L	S		
9,3	4,4		

Sipariş Kodu Order Code Best.-Nr.	Stok/Stock/Lager	Ürün Kodu Product Code Produkt-Code	Ölçüler (mm) Dimensions (mm) Abmessungen (mm)					Kullanılan Uç Insert WSP	Sıkma Cıvatası Clamp Screw Torx-Schraube	Anahtar Torx Key Torx-Schlüssel
			ØD	Z	L	ød	L1			
S295	●	D20 d20 Z03 L150 LO--08	20	3	150	20	40	LOEX 0804 SCO	TC063 M2,5x7	T8
S296	●	D25 d25 Z04 L150 LO--08	20	4	150	25	40			

SCO ucuna uygundur. / Compatible with SCO insert. / Kompatible für SCO WP

S22
BDMT 11T3



Ölçüler (mm) Dimensions (mm) Abmessungen (mm)		BDMT 11T3	
L	S		
11	3,80		

Sipariş Kodu Order Code Best.-Nr.	Stok/Stock/Lager	Ürün Kodu Product Code Produkt-Code	Ölçüler (mm) Dimensions (mm) Abmessungen (mm)					Kullanılan Uç Insert WSP	Sıkma Cıvatası Clamp Screw Torx-Schraube	Anahtar Torx Key Torx-Schlüssel
			ØD	Z	L	ød	L1			
S565	●	D16 d16 Z02 L150 BD--11	16	2	150	16	45			
S566	●	D18 d16 Z02 L150 BD--11	18	2	150	16	44			
S567	●	D20 d20 Z03 L150 BD--11	20	3	150	20	50			
S569	●	D25 d25 Z03 L150 BD--11	25	3	150	25	50			
S570	●	D25 d25 Z03 L200 BD--11	25	3	200	25	60			
S572	●	D32 d32 Z04 L150 BD--11	32	4	150	32	50			
S574	●	D32 d32 Z04 L200 BD--11	32	4	200	32	60			

S23
BDMT 1704

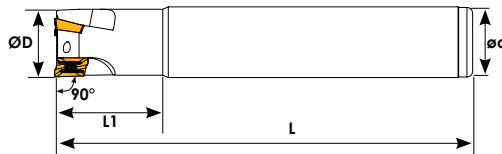
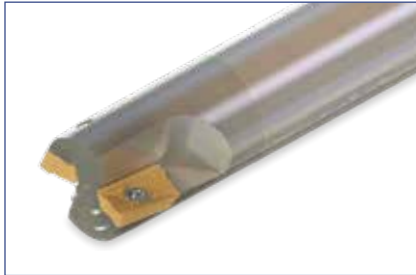

Ölçüler (mm) Dimensions (mm) Abmessungen (mm)		BDMT 1704	
L	S		
17	4,90		

Sipariş Kodu Order Code Best.-Nr.	Stok/Stock/Lager	Ürün Kodu Product Code Produkt-Code	Ölçüler (mm) Dimensions (mm) Abmessungen (mm)					Kullanılan Uç Insert WSP	Sıkma Cıvatası Clamp Screw Torx-Schraube	Anahtar Torx Key Torx-Schlüssel
			ØD	Z	L	ød	L1			
S578	●	D25 d25 Z02 L120 BD--17	25	2	120	25	35			
S579	●	D25 d25 Z02 L150 BD--17	25	2	150	25	50			
S581	●	D32 d25 Z03 L120 BD--17	32	3	120	25	40			
S582	●	D32 d32 Z03 L150 BD--17	32	3	150	32	60			
S584	●	D40 d32 Z04 L120 BD--17	40	4	120	32	40			
S585	●	D40 d32 Z04 L150 BD--17	40	4	150	32	40			

KYCRA ucuna uygundur. / Compatible with KYCRA insert. / Kompatibel für KYCRA WP

R390-11T3

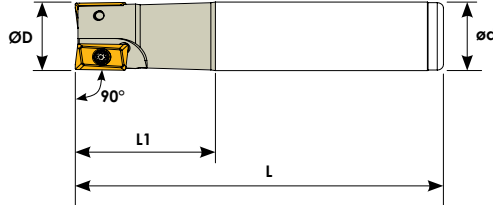

Ölçüler (mm) Dimensions(mm) Abmessungen (mm)		R390-11T3	
L	S	11	3,5

Sipariş Kodu Order Code Best.-Nr.	Stok/Stock/Lager	Ürün Kodu Product Code Produkt-Code	Ölçüler (mm) Dimensions(mm) Abmessungen (mm)					Sıkma Cıvatası Clamp Screw Torx-Schraube	Kullanılan Uç Insert WSP	Anahtar Torx Key Torx-Schlüssel
			ØD	Z	L	ød	L1			
S591	●	D16 d16 Z02 L120 AP--11	16	2	120	16	40	TC060 M2,5x5,5	R390-11T3 SNDVK	T8
S592	●	D20 d20 Z03 L120 AP--11	20	3	120	20	40	TC063 M2,5x7		
S592-1	●	D25 d25 Z03 L120 AP--11	25	3	120	25	45	TC063 M2,5x7		
S593	●	D16 d16 Z02 L150 AP--11	16	2	150	16	40	TC060 M2,5x5,5		
S593-1	●	D17 d16 Z02 L150 AP--11	17	2	150	16	40	TC063 M2,5x7		
S594	●	D20 d20 Z03 L150 AP--11	20	3	150	20	50			
S594-1	●	D21 d20 Z03 L150 AP--11	21	3	150	20	50			
S595	●	D25 d25 Z03 L150 AP--11	25	3	150	25	50			
S595-1	●	D26 d25 Z04 L150 AP--11	26	4	150	25	50			
S596	●	D20 d20 Z03 L200 AP--11	20	3	200	20	50			
S597	●	D25 d25 Z03 L200 AP--11	25	3	200	25	50			
S598	●	D25 d25 Z03 L250 AP--11	25	3	250	25	60			

S25 R390-1704

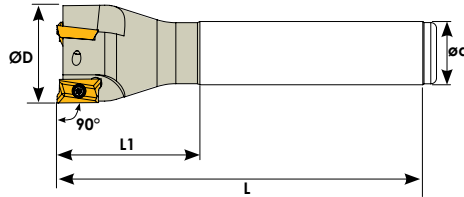
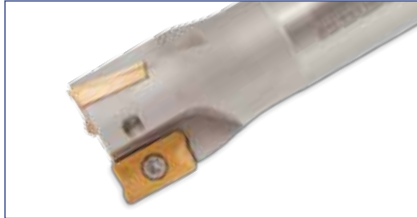

Ölçüler (mm) Dimensions(mm) Abmessungen (mm)		R390-1704	
L	S	17	4,76

Sipariş Kodu Order Code Best.-Nr.	Stok/Stock/Lager	Ürün Kodu Product Code Produkt-Code	Ölçüler (mm) Dimensions(mm) Abmessungen (mm)					Kullanılan Uç Insert WSP	Sıkma Cıvatası Clamp Screw Torx-Schraube	Anahtar Torx Key Torx-Schlüssel
			ØD	Z	L	ød	L1			
S510	●	D25 d25 Z02 L120 AP--17	25	2	120	25	45	R390-1704 SNDVK	TC067-1 M3,5x8,5	T15
S512	●	D30 d25 Z03 L120 AP--17	30	3	120	25	45			
S514	●	D32 d25 Z03 L120 AP--17	32	3	120	25	45			
S518	●	D40 d32 Z04 L120 AP--17	40	4	120	32	45			
S520	●	D25 d25 Z02 L150 AP--17	25	2	150	25	55			
S522	●	D30 d25 Z03 L150 AP--17	30	3	150	25	55			
S524	●	D32 d32 Z03 L150 AP--17	32	3	150	32	55			
S528	●	D40 d32 Z04 L150 AP--17	40	4	150	32	55			
S530	●	D25 d25 Z02 L200 AP--17	25	2	200	25	60			
S532	●	D30 d25 Z03 L200 AP--17	30	3	200	25	55			
S534	●	D32 d32 Z03 L200 AP--17	32	3	200	32	55			
S538	●	D40 d32 Z04 L200 AP--17	40	4	200	32	55			
S548	●	D25 d25 Z02 L300 AP--17	25	2	300	25	70			
S550	●	D32 d32 Z03 L300 AP--17	32	3	300	32	80			

SNDVK ucuna uygundur. / Compatible with SNDVK insert. / Kompatibel für SNDVK WP

S26
R390-1806

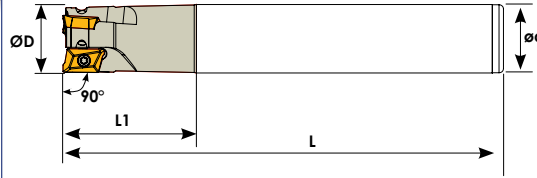

Ölçüler (mm) Dimensions (mm) Abmessungen (mm)	
L	S
18	6,3

R390-1806

Sipariş Kodu Order Code Best.-Nr.	Stok/Stock/Lager	Ürün Kodu Product Code Produkt-Code	Ölçüler (mm) Dimensions (mm) Abmessungen (mm)					Kullanılan Uç Insert WSP	Sıkma Cıvatası Clamp Screw Torx-Schraube	Anahtar Torx Key Torx-Schlüssel
			ØD	Z	L	ød	L1			
S603	●	D25 d25 Z02 L150 AP--18	25	2	150	25	60	R390-1806 SNDVK	TC074 M4x10	T15
S600	●	D25 d25 Z02 L200 AP--18	25	2	200	25	60			
S605	●	D32 d32 Z03 L150 AP--18	32	3	150	32	60			
S601	●	D32 d32 Z03 L200 AP--18	32	3	200	32	60			

SNDVK ucuna uygundur. / Compatible with SNDVK insert. / Kompatible für SNDVK WP

S27
APKT 0903

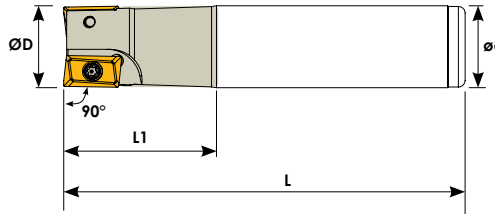

Ölçüler (mm) Dimensions (mm) Abmessungen (mm)	
L	S
9,52	3,18

APKT 0903

Sipariş Kodu Order Code Best.-Nr.	Stok/Stock/Lager	Ürün Kodu Product Code Produkt-Code	Ölçüler (mm) Dimensions (mm) Abmessungen (mm)					Sıkma Cıvatası Clamp Screw Torx-Schraube	Kullanılan Uç Insert WSP	Anahtar Torx Key Torx-Schlüssel
			ØD	Z	L	ød	L1			
S204	●	D16 d16 Z02 L120 AP--09	16	2	120	16	40	TC060 M2,5x5,5	APKT 0903 WLTR	T8
S206	●	D20 d20 Z03 L120 AP--09	20	3	120	20	45			
S208	●	D25 d25 Z03 L120 AP--09	25	3	120	25	45			
S210	●	D16 d16 Z02 L150 AP--09	16	2	150	16	50			
S212	●	D20 d20 Z03 L150 AP--09	20	3	150	20	45			
S214	●	D25 d25 Z03 L150 AP--09	25	3	150	25	45			
S216	●	D16 d16 Z02 L200 AP--09	16	2	200	16	60			
S218	●	D20 d20 Z03 L200 AP--09	20	3	200	20	60			
S220	●	D25 d25 Z03 L200 AP--09	25	3	200	25	60			

WLTR ucuna uygundur. / Compatible with WLTR insert. / Kompatible für WLTR WP

S28 ADMT 1204

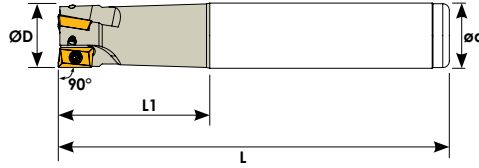

Ölçüler (mm) Dimensions (mm) Abmessungen (mm)	
L	S
13,6	4,76

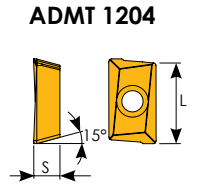

Sipariş Kodu Order Code Best.-Nr.	Stok/Stock/Lager	Ürün Kodu Product Code Produkt-Code	Ölçüler (mm) Dimensions (mm) Abmessungen (mm)					Kullanılan Uç Insert WSP	Sıkma Civatası Clamp Screw Torx-Schraube	Anahtar Torx Key Torx-Schlüssel
			ØD	Z	L	ød	L1			
S498	●	D20 d20 Z02 L120 AD--12	20	2	120	20	40	AD-- 1204 WLTR	TC065 M3x7	T8
S500	●	D20 d20 Z02 L150 AD--12	20	2	150	20	55			
S501	●	D20 d20 Z02 L200 AD--12	20	2	200	20	60			
S501-1	●	D25 d25 Z03 L120 AD--12	25	3	120	25	40			
S502	●	D25 d25 Z03 L150 AD--12	25	3	150	25	60			
S503	●	D30 d25 Z04 L150 AD--12	30	4	150	25	60			
S504	●	D32 d32 Z04 L150 AD--12	32	4	150	32	50			
S506	●	D40 d32 Z05 L150 AD--12	40	5	150	32	50			

S29 ADMT 1606

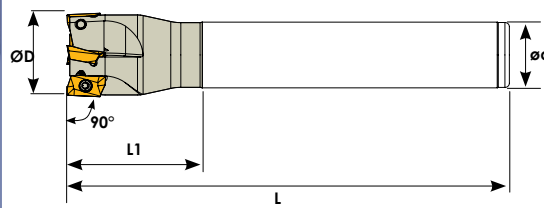

Ölçüler (mm) Dimensions (mm) Abmessungen (mm)	
L	S
17,5	6,15

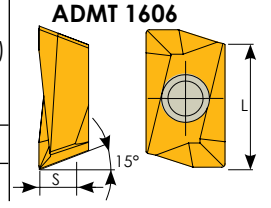

Sipariş Kodu Order Code Best.-Nr.	Stok/Stock/Lager	Ürün Kodu Product Code Produkt-Code	Ölçüler (mm) Dimensions (mm) Abmessungen (mm)					Kullanılan Uç Insert WSP	Sıkma Civatası Clamp Screw Torx-Schraube	Anahtar Torx Key Torx-Schlüssel
			ØD	Z	L	ød	L1			
S460	●	D25 d25 Z02 L150 AD--16	25	2	150	25	60	AD-- 1606 WLTR	TC079 M4x10	T15
S461	●	D25 d25 Z02 L200 AD--16	25	2	200	25	60			
S463	●	D26 d25 Z02 L150 AD--16	26	2	150	25	60			
S464	●	D26 d25 Z02 L200 AD--16	26	2	200	25	60			
S466	●	D32 d32 Z03 L150 AD--16	32	3	150	32	60			
S467	●	D32 d32 Z03 L200 AD--16	32	3	200	32	60			
S469	●	D40 d32 Z04 L150 AD--16	40	4	150	32	60			
S470	●	D40 d32 Z04 L200 AD--16	40	4	200	32	60			

WLTR ucuna uygundur. / Compatible with WLTR insert. / Kompatibel für WLTR WP

S30
LNHU 0904

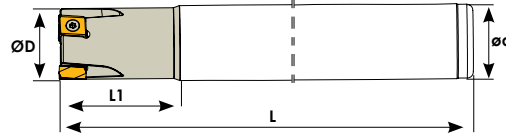

Ölçüler (mm) Dimensions (mm) Abmessungen (mm)			LNHU 0904	
I	I1	S	I	S
8	9	3,5	I1	S

Sipariş Kodu Order Code Best.-Nr.	Stok/Stock/Lager	Ürün Kodu Product Code Produkt-Code	Ölçüler (mm) Dimensions (mm) Abmessungen (mm)					Kullanılan Uç Insert WSP	Sıkma Cıvatası Clamp Screw Torx-Schraube	Anahtar Torx Key Torx-Schlüssel
			ØD	Z	L	ød	L1			
S328	●	D25 d25 Z03 L150 LH--09	25	3	150	25	40	LNHU 0904 WLTR	TC065 M3x7	T8
S329	●	D32 d32 Z04 L150 LH--09	32	4	150	32	40			

S31

Küre Uçlu Freze

Indexable Ball Nose End Mill

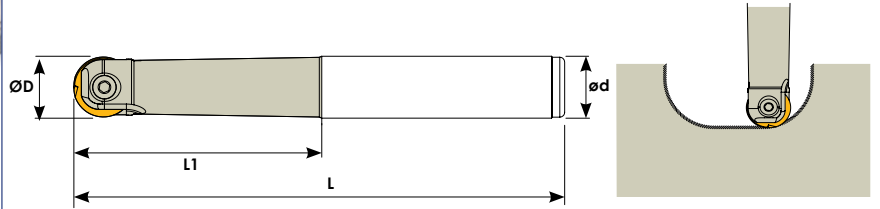

Sipariş Kodu Order Code Best.-Nr.	Stok/Stock/Lager	Ürün Kodu Product Code Produkt-Code	Ölçüler (mm) Dimensions (mm) Abmessungen (mm)				Kullanılan Uç Insert WSP	Sıkma Cıvatası Clamp Screw Torx-Schraube	Anahtar Torx Key Torx-Schlüssel
			ØD	L	ød	L1			
S370	●	D08 d10 L130 P32-08	8	130	10	36	P32 08 WLTR	TC170 M3	T8
S372	●	D10 d12 L130 P32-10	10	130	12	46	P32 10 WLTR	TC172 M4	T15
S374	●	D12 d12 L150 P32-12	12	150	12	46	P32 12 WLTR	TC174 M5	T20
S376	●	D16 d16 L175 P32-16	16	175	16	46	P32 16 WLTR	TC176 M5	T20
S378	●	D20 d20 L200 P32-20	20	200	20	56	P32 20 WLTR	TC178 M5	T20
S380	●	D25 d25 L200 P32-25	25	200	25	66	P32 25 WLTR	TC181 M6	3 Allen
S381	●	D30 d32 L200 P32-30	30	200	32	66	P32 30 WLTR	TC184 M8	4 Allen
S382	●	D32 d32 L200 P32-32	32	200	32	66	P32 32 WLTR	TC184 M8	4 Allen

WLTR ucuna uygundur. / Compatible with WLTR insert. / Kompatible für WLTR WP

S32 LNMT 0804

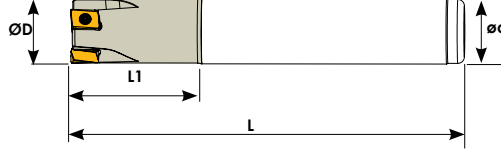

Ölçüler (mm) Dimensions (mm) Abmessungen (mm)			LNMT 0804	
L	S	A		

Sipariş Kodu Order Code Best.-Nr.	Stok/Stock/Lager	Ürün Kodu Product Code Produkt-Code	Ölçüler (mm) Dimensions (mm) Abmessungen (mm)					Kullanılan Uç Insert WSP	Sıkma Cıvatası Clamp Screw Torx-Schraube	Anahtar Torx Key Torx-Schlüssel
			ØD	Z	L	ød	L1			
S298	●	D16 d16 Z02 L120 LN--08	16	2	120	16	40	LNMT 0804 ISCR	TC063 M2,5x7	T8
S299	●	D20 d20 Z03 L120 LN--08	20	3	120	20	40			
S300	●	D25 d25 Z04 L120 LN--08	25	4	120	25	40			
S300-1	●	D32 d32 Z05 L120 LN--08	32	5	120	32	40			
S301	●	D16 d16 Z02 L150 LN--08	16	2	150	16	40			
S302	●	D20 d20 Z03 L150 LN--08	20	3	150	20	40			
S303	●	D25 d25 Z04 L150 LN--08	25	4	150	25	40			
S303-1	●	D32 d32 Z05 L150 LN--08	32	5	150	32	40			

S33 ADKT 1505

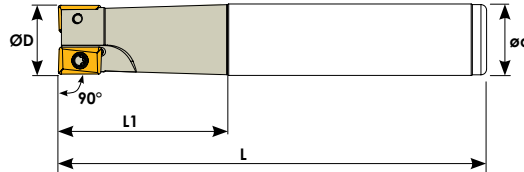

Ölçüler (mm) Dimensions (mm) Abmessungen (mm)		ADKT 1505	
L	S		
15,7	5,63		

Sipariş Kodu Order Code Best.-Nr.	Stok/Stock/Lager	Ürün Kodu Product Code Produkt-Code	Ölçüler (mm) Dimensions (mm) Abmessungen (mm)					Kullanılan Uç Insert WSP	Sıkma Cıvatası Clamp Screw Torx-Schraube	Anahtar Torx Key Torx-Schlüssel
			ØD	Z	L	ød	L1			
S304	●	D25 d25 Z02 L120 AD--15	25	2	120	25	45	ADKT 1505 ISCR	TC074 M4x10	T15
S306	●	D30 d25 Z03 L120 AD--15	30	3	120	25	45			
S307	●	D32 d25 Z03 L120 AD--15	32	3	120	25	45			
S308	●	D35 d25 Z03 L120 AD--15	35	3	120	25	45			
S310	●	D40 d32 Z04 L120 AD--15	40	4	120	32	45			
S312	●	D25 d25 Z02 L150 AD--15	25	2	150	25	60			
S314	●	D30 d25 Z03 L150 AD--15	30	3	150	25	50			
S315	●	D32 d32 Z03 L150 AD--15	32	3	150	32	60			
S316	●	D35 d32 Z03 L150 AD--15	35	3	150	32	50			
S317	●	D40 d32 Z04 L150 AD--15	40	4	150	32	45			
S318	●	D25 d25 Z02 L200 AD--15	25	2	200	25	55			
S319	●	D30 d25 Z03 L200 AD--15	30	3	200	25	50			
S320	●	D32 d32 Z03 L200 AD--15	32	3	200	32	60			
S321	●	D35 d32 Z03 L200 AD--15	35	3	200	32	50			
S322	●	D40 d32 Z04 L200 AD--15	40	4	200	32	60			
S327	●	D40 d32 Z04 L250 AD--15	40	4	250	32	60			

ISCR ucuna uygundur. / Compatible with ISCR insert. / Kompatibel für ISCR WP

S34
ANKX 1205

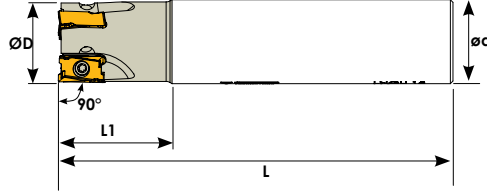

Ölçüler (mm) Dimensions (mm) Abmessungen (mm)			ANKX 1205	
L	S	A		
13,7	9,15	9,3	A	S

Sipariş Kodu Order Code Best.-Nr.	Stok/Stock/Lager	Ürün Kodu Product Code Produkt-Code	Ölçüler (mm) Dimensions (mm) Abmessungen (mm)					Kullanılan Uç Insert WSP	Sıkma Cıvatası Clamp Screw Torx-Schraube	Anahtar Torx Key Torx-Schlüssel
			ØD	Z	L	ød	L1			
S695	●	D32 d32 Z03 L120 AN--12	32	3	120	32	40			
								ANKX1205 ISCR	TC097 M4x11	T15

ISCR ucuna uygundur. / Compatible with ISCR insert. / Kompatible für ISCR WP

S35
BOMT 1304

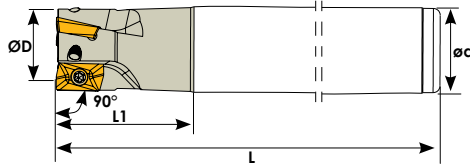

Ölçüler (mm) Dimensions (mm) Abmessungen (mm)			BOMT 1304	
L	S	A		
13	4,5	8	S	A

Sipariş Kodu Order Code Best.-Nr.	Stok/Stock/Lager	Ürün Kodu Product Code Produkt-Code	Ölçüler (mm) Dimensions (mm) Abmessungen (mm)					Kullanılan Uç Insert WSP	Sıkma Cıvatası Clamp Screw Torx-Schraube	Anahtar Torx Key Torx-Schlüssel
			ØD	Z	L	ød	L1			
S850	●	D20 d20 Z02 L120 BO--13	20	2	120	20	40			
S851	●	D20 d20 Z02 L150 BO--13	20	2	150	20	40	BOMT 1304 INGRSLL	TC069 M3,5x8,5	T10
S852	●	D25 d25 Z03 L120 BO--13	25	3	120	25	40			
S853	●	D25 d25 Z03 L150 BO--13	25	3	150	25	40			

INGRSLL ucuna uygundur. / Compatible with INGRSLL insert. / Kompatible für INGRSLL WP

S36

AXMT 0602 - 0903

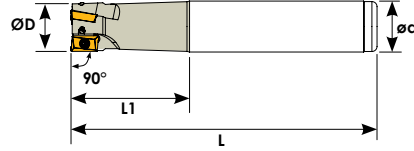

Ölçüler (mm) Dimensions(mm) Abmessungen (mm)		AXMT 0602	AXMT 0903
L	S		
9,5	3,6		
6	2,6		

Sipariş Kodu Order Code Best.-Nr.	Stok/Stock/Lager	Ürün Kodu Product Code Produkt-Code	Ölçüler (mm) Dimensions(mm) Abmessungen (mm)					Kullanılan Uç Insert WSP	Sıkma Civatası Clamp Screw Torx-Schraube	Anahtar Torx Key Torx-Schlüssel
			ØD	Z	L	ød	L1			
S010	●	D10 d10 Z02 L120 AX--06	10	2	120	10	30	AXMT 0602 TGTC	TC051 M1,8x4	T6
S012	●	D12 d12 Z02 L120 AX--06	12	2	120	12	30			
S014	●	D16 d16 Z02 L120 AX--09	16	2	120	16	40			
S016	●	D20 d20 Z03 L120 AX--09	20	3	120	20	45	AXMT 0903 TGTC	TC060 M2,5x5,5	T8
S018	●	D25 d25 Z03 L120 AX--09	25	3	120	25	45			
S020	●	D16 d16 Z02 L150 AX--09	16	2	150	16	50			
S022	●	D20 d20 Z03 L150 AX--09	20	3	150	20	60			
S024	●	D25 d25 Z03 L150 AX--09	25	3	150	25	60			
S026	●	D16 d16 Z02 L200 AX--09	16	2	200	16	60			
S028	●	D20 d20 Z03 L200 AX--09	20	3	200	20	70			
S030	●	D25 d25 Z03 L200 AX--09	25	3	200	25	70			

S37

APKT 1705

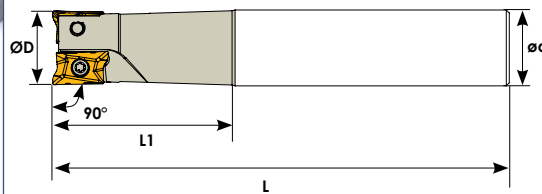

Ölçüler (mm) Dimensions(mm) Abmessungen (mm)		AP -- 1705	
L	S		
17	5,56		

Sipariş Kodu Order Code Best.-Nr.	Stok/Stock/Lager	Ürün Kodu Product Code Produkt-Code	Ölçüler (mm) Dimensions(mm) Abmessungen (mm)					Kullanılan Uç Insert WSP	Sıkma Civatası Clamp Screw Torx-Schraube	Anahtar Torx Key Torx-Schlüssel
			ØD	Z	L	ød	L1			
S660	●	D25 d25 Z02 L150 AP--17	25	2	150	25	60	AP-- 1705 TGTC	TC096 M4x10	T15
S660-1	●	D25 d25 Z02 L200 AP--17	25	2	200	25	60			
S662	●	D32 d32 Z03 L150 AP--17	32	3	150	32	60			
S662-1	●	D32 d32 Z03 L200 AP--17	32	3	200	32	60			
S664	●	D40 d32 Z04 L150 AP--17	40	4	150	32	60			

TGTCucuna uygundur. / Compatible with TGTCinsert. / Kompatible für TGTCWP

S38
4NKT 06

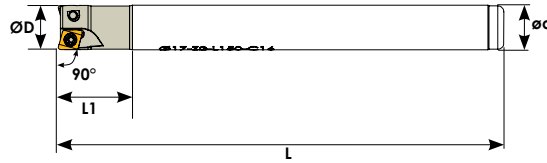

Ölçüler (mm)
Dimensions (mm)
Abmessungen (mm)

L	S
6,6	4,67

4NKT 06

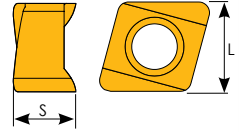

Sipariş Kodu Order Code Best.-Nr.	Stok/Stock/Lager	Ürün Kodu Product Code Produkt-Code	Ölçüler (mm) Dimensions (mm) Abmessungen (mm)					Kullanılan Uç Insert WSP	Sıkma Cıvatası Clamp Screw Torx-Schraube	Anahtar Torx Key Torx-Schlüssel
			ØD	Z	L	ød	L1			
S471	●	D16 d16 Z02 L120 4N--06	16	2	120	16	25	4NKT 06 TGTC	TC064 M3x6,5	T8
S471-1	●	D16 d16 Z02 L150 4N--06	16	2	150	16	25			
S472	●	D17 d16 Z02 L150 4N--06	17	2	150	16	22			
S473	●	D20 d20 Z03 L120 4N--06	20	3	120	20	25			
S474	●	D21 d20 Z03 L200 4N--06	21	3	200	20	25			
S475	●	D25 d25 Z04 L120 4N--06	25	4	120	25	30			
S475-1	●	D25 d25 Z03 L200 4N--06	25	3	200	25	30			
S476	●	D26 d25 Z03 L200 4N--06	26	3	200	25	30			
S477	●	D33 d32 Z04 L200 4N--06	33	4	200	32	35			
S477-1	●	D33 d32 Z04 L220 4N--06	33	4	220	32	35			
S477-2	●	D40 d32 Z05 L200 4N--06	40	5	200	32	40			

S39
BLMP 0603

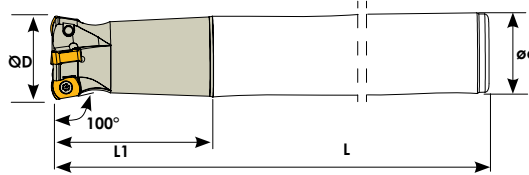

Ölçüler (mm)
Dimensions (mm)
Abmessungen (mm)

d	l	s
6,39	9	3,73

BLMP 0603

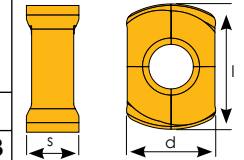

Sipariş Kodu Order Code Best.-Nr.	Stok/Stock/Lager	Ürün Kodu Product Code Produkt-Code	Ölçüler (mm) Dimensions (mm) Abmessungen (mm)					Kullanılan Uç Insert WSP	Sıkma Cıvatası Clamp Screw Torx-Schraube	Anahtar Torx Key Torx-Schlüssel
			ØD	Z	L	ød	L1			
S478	●	D17 d16 Z02 L150 BL--06	17	2	150	16	40	BLMP 0603 TGTC	TC064 M3x6,5	T8
S479	●	D16 d20 Z03 L150 BL--06	16	3	150	20	40			
S480	●	D21 d20 Z03 L200 BL--06	21	3	200	20	40			
S482	●	D26 d25 Z04 L200 BL--06	26	4	200	25	40			

TGTCucuna uygundur. / Compatible with TGTCinsert. / Kompatible für TGTCWP

S40
3PKT 1004

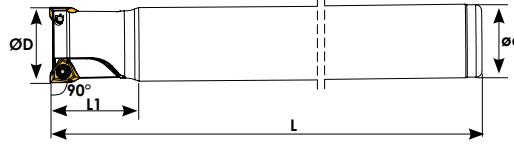

Ölçüler (mm) Dimensions (mm) Abmessungen (mm)			3PKT 1004	
d	l	s		
6,9	7	4		

Sipariş Kodu Order Code Best.-Nr.	Stok/Stock/Lager	Ürün Kodu Product Code Produkt-Code	Ölçüler (mm) Dimensions (mm) Abmessungen (mm)					Kullanılan Uç Insert WSP	Sıkma Cıvatası Clamp Screw Torx-Schraube	Anahtar Torx Key Torx-Schlüssel
			ØD	Z	L	ød	L1			
S485	●	D21 d20 Z02 L200 3P--10	21	2	200	20	30	3PKT 1004 TGTC	TC098 M2,5x7	T15
S486	●	D26 d25 Z02 L200 3P--10	26	2	200	25	30			
S487	●	D33 d32 Z03 L200 3P--10	33	3	200	32	40			

S41

SPMG 0502 - 0602 - 07T3 - 0904



Ölçüler (mm) Dimensions (mm) Abmessungen (mm)		SPMG 0502	SPMG 0602
L	S		
5	2,38		
6	2,38		

Ölçüler (mm) Dimensions (mm) Abmessungen (mm)		SPMG 07T3	SPMG 0904
L	S		
7,94	3,97		
9,8	4,3		

Sipariş Kodu Order Code Best.-Nr.	Stok/Stock/Lager	Ürün Kodu Product Code Produkt-Code	Ölçüler (mm) Dimensions (mm) Abmessungen (mm)					Kullanılan Uç Insert WSP	Sıkma Cıvatası Clamp Screw Torx-Schraube	Anahtar Torx Key Torx-Schlüssel
			ØD	Z	L	ød	L1			
S810	●	D013 d14 Z02 L120 SP--05	13	2	120	14	40	SPMG 0502 TGTC	TC058 M2x4,2	T6
S812	●	D13,5 d14 Z02 L120 SP--05	13,5	2	120	14	40			
S814	●	D014 d14 Z02 L120 SP--06	14	2	120	14	40	SPMG 0602 TGTC	TC059 M2,2x5	T7
S816	●	D14,5 d14 Z02 L120 SP--06	14,5	2	120	14	40			
S818	●	D015 d16 Z02 L120 SP--06	15	2	120	16	40			
S820	●	D15,5 d16 Z02 L120 SP--06	15,5	2	120	16	40			
S822	●	D016 d16 Z02 L120 SP--06	16	2	120	16	40			
S824	●	D020 d20 Z02 L150 SP--07	20	2	150	20	50			
S826	●	D20,5 d20 Z02 L120 SP--07	20,5	2	120	20	50	SPMG 07T3 TGTC	TC063 M2,5x7	T8
S828	●	D025 d25 Z02 L150 SP--09	25	2	150	25	50	SPMG 0904 TGTC	TC067 M3,5x9	T15
S830	●	D032 d32 Z03 L150 SP--09	32	3	150	32	40			

TGTCucuna uygundur. / Compatible with TGTCinsert. / Kompatible für TGTCWP

S42

SDMT 09T3

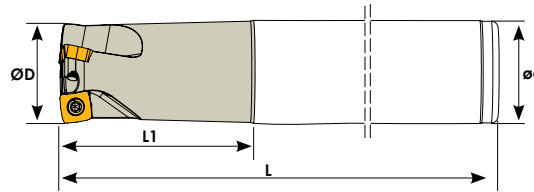

Ölçüler (mm)
Dimensions (mm)
Abmessungen (mm)

L	S
9,52	3,97

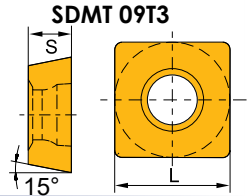

Sipariş Kodu Order Code Best.-Nr.	Ürün Kodu Product Code Produkt-Code	Ölçüler (mm) Dimensions (mm) Abmessungen (mm)					Kullanılan Uç Insert WSP	Sıkma Cıvatası Clamp Screw Torx-Schraube	Anahtar Torx Key Torx-Schlüssel
		ØD	Z	L	ød	L1			
S395	D25 d25 Z02 L150 SD--09	25	2	150	25	60	SDMT 09T3 ZCC	TC067 M3,5x9	T15
S396	D32 d32 Z03 L150 SD--09	32	3	150	32	60			

S43

Küre Uçlu Freze

Indexable Ball Nose End Mill

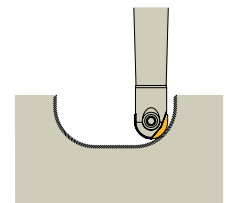
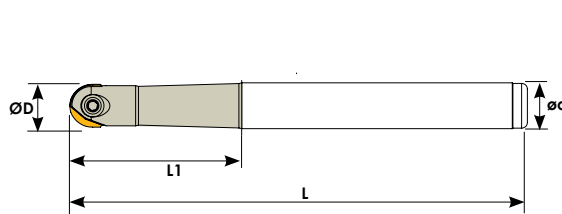
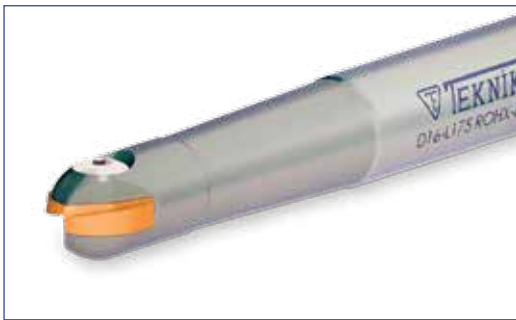

Sipariş Kodu Order Code Best.-Nr.	Stok/Stok/Lager	Ürün Kodu Product Code Produkt-Code	Ölçüler (mm) Dimensions (mm) Abmessungen (mm)				Kullanılan Uç Insert WSP	Sıkma Cıvatası Clamp Screw Torx-Schraube	Anahtar Torx Key Torx-Schlüssel
			ØD	L	ød	L1			
S364	●	D12 d12 L150 ROHX	12	150	12	35	ROHX D12 ZCC	TC172 M4	T15
S366	●	D16 d16 L160 ROHX	16	160	16	45	ROHX D16 ZCC	TC176 M5	T20
S368	●	D20 d20 L180 ROHX	20	180	20	56	ROHX D20 ZCC	TC178 M5	T20

ZCC ucuna uygundur. / Compatible with ZCC insert. / Kompatibel für ZCC WP

S44
RT 0702
RT 1003
RT 1606

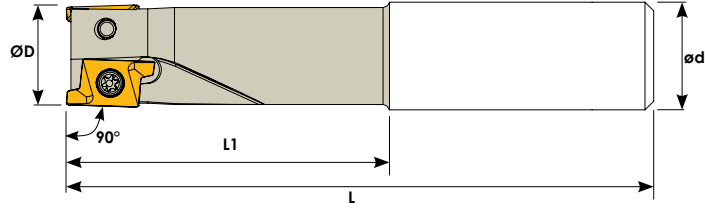

Ölçüler (mm) Dimensions(mm) Abmessungen (mm)	
L	S
7	2,38

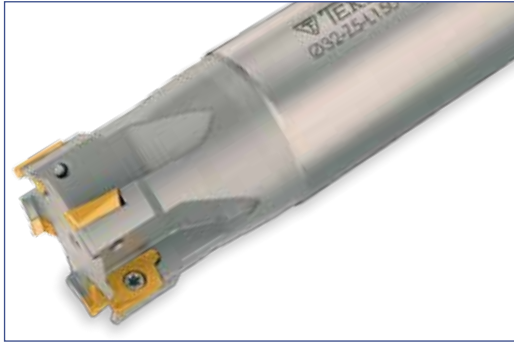
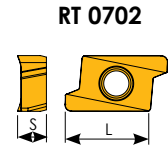

Ölçüler (mm) Dimensions(mm) Abmessungen (mm)	
L	S
10 18	3,4 6,35

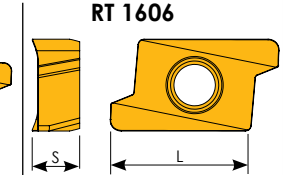
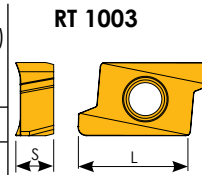

Sipariş Kodu Order Code Best.-Nr.	Stok/Stock/Lager	Ürün Kodu Product Code Produkt-Code	Ölçüler (mm) Dimensions(mm) Abmessungen (mm)					Kullanılan Uç Insert WSP	Sıkma Cıvatası Clamp Screw Torx-Schraube	Anahtar Torx Key Torx-Schlüssel
			ØD	Z	L	ød	L1			
G100	○	D10 d10 Z02 L120 RT--07	10	2	120	10	30	RT 0702 SFTY	TC058 M2x4,2	T6
G102	○	D12 d12 Z02 L120 RT--07	12	2	120	12	30	RT 1003 SFTY	TC063 M2,5x7	T8
G110	○	D16 d16 Z02 L120 RT--10	16	2	120	16	40			
G114	○	D20 d20 Z03 L120 RT--10	20	3	120	20	40			
G118	○	D25 d25 Z04 L120 RT--10	25	4	120	25	40			
G130	○	D16 d16 Z02 L150 RT--10	16	2	150	16	40			
G134	○	D20 d20 Z03 L150 RT--10	20	3	150	20	60			
G150	○	D16 d16 Z02 L200 RT--10	16	2	200	16	80	RT 1606 SFTY	TC075 M4x11	T15
G152	○	D20 d20 Z03 L200 RT--10	20	3	200	20	80			
G156	○	D25 d25 Z04 L200 RT--10	25	4	200	25	80			
G202	○	D32 d32 Z03 L200 RT--16	32	3	200	32	60			
G206	○	D32 d32 Z03 L250 RT--16	32	3	250	32	60			
G208	○	D32 d32 Z03 L270 RT--16	32	3	270	32	70			

SFTY ucuna uygundur. / Compatible with SFTY insert. / Kompatible für SFTY WP

VCGT 1604

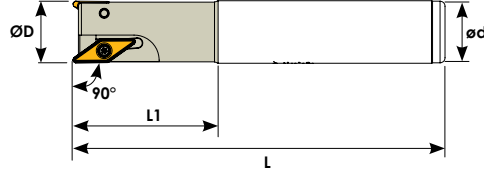

Ölçüler (mm)
Dimensions (mm)
Abmessungen (mm)

L	S
16,6	4,76

VCGT 1604

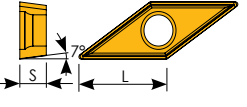

Sipariş Kodu Order Code Best.-Nr.	Stok/Stok/Lager	Ürün Kodu Product Code Produkt-Code	Ölçüler (mm) Dimensions (mm) Abmessungen (mm)					Kullanılan Uç Insert WSP	Sıkma Cıvatası Clamp Screw Torx-Schraube	Anahtar Torx Key Torx-Schlüssel
			ØD	Z	L	ød	L1			
S710	●	D25 d25 Z02 L150 VC--16	25	2	150	25	50	VCGT 1604 ISO	TC074 M4x10	T15
S712	●	D32 d32 Z02 L150 VC--16	32	2	150	32	60			
S714	●	D40 d32 Z03 L150 VC--16	40	3	150	32	60			
S718	●	D25 d25 Z02 L200 VC--16	25	2	200	25	60			
S720	●	D32 d32 Z02 L200 VC--16	32	2	200	32	60			
S724	●	D25 d25 Z02 L250 VC--16	25	2	250	25	60			
S726	●	D32 d32 Z02 L250 VC--16	32	2	250	32	60			

VCGT 16 ISO'dur. / VCGT 16 is ISO. / Kompatible für ISO WP

TPKN 1103 - 1603 - 2204

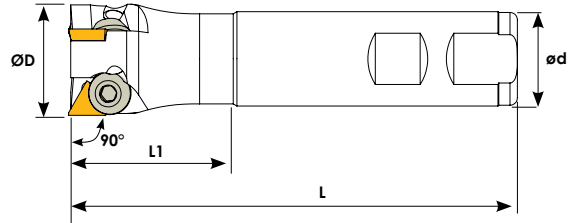

Ölçüler (mm)
Dimensions (mm)
Abmessungen (mm)

L	S
11	3,18
16,5	3,18
22	4,76

TPKN 1103

TPKN 1603

TPKN 2204

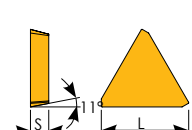

Sipariş Kodu Order Code Best.-Nr.	Stok/Stok/Lager	Ürün Kodu Product Code Produkt-Code	Ölçüler (mm) Dimensions (mm) Abmessungen (mm)					Kullanılan Uç Insert WSP	Baskı Cıvatası Locking Screw Verriegelungsschraub	Anahtar Allen Key Inbuss-Schlüssel
			ØD	Z	L	ød	L1			
S116	●	D22 d20 Z02 L120 TP--11	22	2	120	20	45	TPKN 1103 ISO	TC050 M6x14	3 Allen
S118	●	D25 d25 Z02 L120 TP--11	25	2	120	25	45			
S120	●	D28 d25 Z02 L120 TP--11	28	2	120	25	45			
S122	●	D30 d25 Z03 L120 TP--11	30	3	120	25	45			
S124	●	D32 d25 Z03 L120 TP--11	32	3	120	25	45			
S126	●	D35 d25 Z03 L120 TP--11	35	3	120	25	45			
S128	●	D35 d25 Z02 L120 TP--16	35	2	120	25	45	TPKN 1603 ISO	TC052 M6x17	4 Allen
S130	●	D40 d25 Z03 L120 TP--16	40	3	120	25	45			
S132	●	D45 d25 Z03 L120 TP--16	45	3	120	25	45			
S134	●	D50 d32 Z03 L120 TP--22	50	3	120	32	55	TPKN 2204 ISO	TC054 M8x24	5 Allen

TPKN 1103-1603-2204 ISO'dur. / TPKN 1103-1603-2204 is ISO. / Kompatible für ISO WP

S45
RDMW 0501

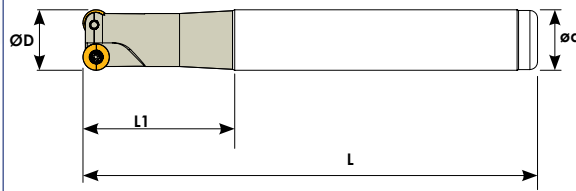

Ölçüler (mm) Dimensions (mm) Abmessungen (mm)		RDMW 0501	
d	S		
5	1,5		

Sipariş Kodu Order Code Best.-Nr.	Stok/Stock/Lager	Ürün Kodu Product Code Produkt-Code	Ölçüler (mm) Dimensions (mm) Abmessungen (mm)					Kullanılan Uç Insert WSP	Sıkma Cıvatası Clamp Screw Torx-Schraube	Anahtar Torx Key Torx-Schlüssel
			ØD	Z	L	ød	L1			
R080	●	D08 d10 Z01 L080 RD--05	8	1	80	10	27	RD-- 0501 TGTC	TC058 M2x4,2	T6
R082	●	D10 d12 Z02 L080 RD--05	10	2	80	12	34			
R084	●	D10 d12 Z02 L120 RD--05	10	2	120	12	45			
R086	●	D12 d12 Z02 L100 RD--05	12	2	100	12	40			
R088	●	D12 d12 Z02 L120 RD--05	12	2	120	12	45			

S46
RDMW 0702

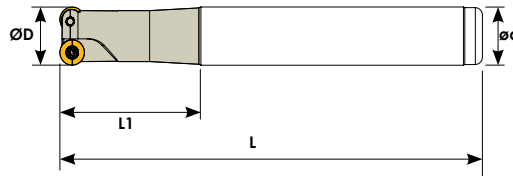

Ölçüler (mm) Dimensions (mm) Abmessungen (mm)		RDMW 0702	
d	S		
7	2,38		

Sipariş Kodu Order Code Best.-Nr.	Stok/Stock/Lager	Ürün Kodu Product Code Produkt-Code	Ölçüler (mm) Dimensions (mm) Abmessungen (mm)					Kullanılan Uç Insert WSP	Sıkma Cıvatası Clamp Screw Torx-Schraube	Anahtar Torx Key Torx-Schlüssel
			ØD	Z	L	ød	L1			
R136	●	D15 d16 Z02 L120 RD--07	15	2	120	16	40	RD-- 0702 TGTC	TC060 M2,5x5,5	T8
R138	●	D16 d16 Z02 L120 RD--07	16	2	120	16	40			
R142	●	D20 d20 Z03 L120 RD--07	20	3	120	20	45			
R143	●	D15 d16 Z02 L150 RD--07	15	2	150	16	50			
R144	●	D16 d16 Z02 L150 RD--07	16	2	150	16	60			
R148	●	D20 d20 Z03 L150 RD--07	20	3	150	20	60			

TGTCucuna uygundur. / Compatible with TGTCinsert. / Kompatible für TGTCWP

RDMT 1003

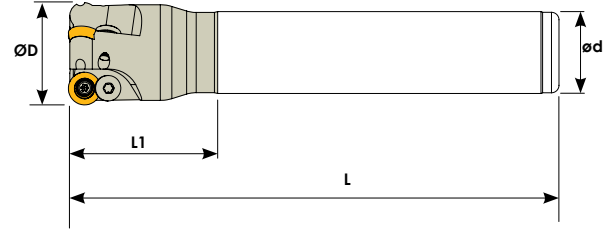

Ölçüler (mm) Dimensions (mm) Abmessungen (mm)		RDMT 1003	
d	S		
10	3,18		

Sipariş Kodu Order Code Best.-Nr.	Stok/Stok/Lager	Ürün Kodu Product Code Produkt-Code	Ölçüler (mm) Dimensions (mm) Abmessungen (mm)					Kullanılan Uç Insert WSP	Sıkma Cıvatası Clamp Screw Torx-Schraube	Baskı Cıvatası Locking Screw Verriegelungs Schraube	Anahtar Torx Key Torx-Schlüssel
			ØD	Z	L	ød	L1				
R190	●	D20 d20 Z02 L120 RD--10	20	2	120	20	55	RD-- 1003 ISO	TC067 M3,5x9	TC040 M3,5	T15
R192	●	D25 d25 Z02 L120 RD--10	25	2	120	25	50				
R193	●	D30 d25 Z03 L120 RD--10	30	3	120	25	40				
R194	●	D32 d25 Z03 L120 RD--10	32	3	120	25	40				
R196	●	D35 d25 Z03 L120 RD--10	35	3	120	25	45				
R198	●	D40 d25 Z04 L120 RD--10	40	4	120	25	45				
R200	●	D20 d20 Z02 L150 RD--10	20	2	150	20	60				
R202	●	D25 d25 Z02 L150 RD--10	25	2	150	25	60				
R203	●	D30 d25 Z03 L150 RD--10	30	3	150	25	40				
R204	●	D32 d32 Z03 L150 RD--10	32	3	150	32	45				
R206	●	D35 d32 Z03 L150 RD--10	35	3	150	32	45				
R208	●	D40 d32 Z04 L150 RD--10	40	4	150	32	45				
R210	●	D20 d20 Z02 L200 RD--10	20	2	200	20	80				
R212	●	D25 d25 Z02 L200 RD--10	25	2	200	25	70				
R213	●	D30 d25 Z03 L200 RD--10	30	3	200	25	40				
R214	●	D32 d32 Z03 L200 RD--10	32	3	200	32	45				
R216	●	D35 d32 Z03 L200 RD--10	35	3	200	32	45				
R218	●	D40 d32 Z04 L200 RD--10	40	4	200	32	45				

RDMT 1003 ISO'dur. / RDMT 1003 is ISO. / Kompatible für ISO WP

RDMT 12T3

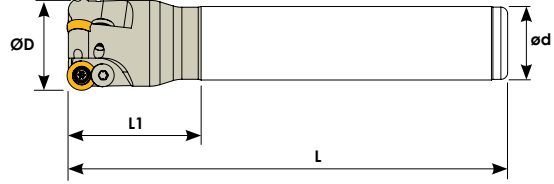

Ölçüler (mm)
Dimensions (mm)
Abmessungen (mm)

d	S
12	3,97

RDMT 12T3

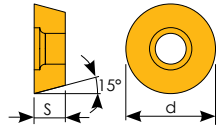

Sipariş Kodu Order Code Best.-Nr.	Stok/Stock/Lager	Ürün Kodu Product Code Produkt-Code	Ölçüler (mm) Dimensions (mm) Abmessungen (mm)					Kullanılan Uç Insert WSP	Sıkma Cıvatası Clamp Screw Torx-Schraube	Baskı Cıvatası Locking Screw Verriegelungs Schraube	Anahtar Torx Key Torx-Schlüssel
			ØD	Z	L	ød	L1				
R228	●	D25 d25 Z02 L120 RD--12	25	2	120	25	50	RD-- 12T3 ISO	TC060 M3,5x9	TC040 M3,5	T15
R229	●	D30 d25 Z02 L120 RD--12	30	2	120	25	40				
R230	●	D32 d25 Z03 L120 RD--12	32	3	120	25	40				
R232	●	D35 d25 Z03 L120 RD--12	35	3	120	25	40				
R234	●	D40 d25 Z03 L120 RD--12	40	3	120	25	40				
R236	●	D25 d25 Z02 L150 RD--12	25	2	150	25	60				
R237	●	D30 d25 Z02 L150 RD--12	30	2	150	25	55				
R238	●	D32 d32 Z03 L150 RD--12	32	3	150	32	45				
R240	●	D35 d32 Z03 L150 RD--12	35	3	150	32	45				
R242	●	D40 d32 Z03 L150 RD--12	40	3	150	32	45				
R244	●	D25 d25 Z02 L200 RD--12	25	2	200	25	70				
R245	●	D30 d25 Z02 L200 RD--12	30	2	200	25	55				
R246	●	D32 d32 Z03 L200 RD--12	32	3	200	32	45				
R248	●	D35 d32 Z03 L200 RD--12	35	3	200	32	45				
R250	●	D40 d32 Z03 L200 RD--12	40	3	200	32	45				
R255	●	D30 d25 Z02 L300 RD--12	30	2	300	25	55				
R256	●	D32 d32 Z03 L300 RD--12	32	3	300	32	70				
R258	●	D35 d32 Z03 L300 RD--12	35	3	300	32	45				
R260	●	D40 d32 Z03 L300 RD--12	40	3	300	32	45				

RDMT 12T3 ISO'dur. / RDMT 12T3 is ISO. / Kompatible für ISO WP



Vidalı Takımları
Modular End Mill
Einschraubfräser

Vidalı Takım Tutucu

Screw Head Holder

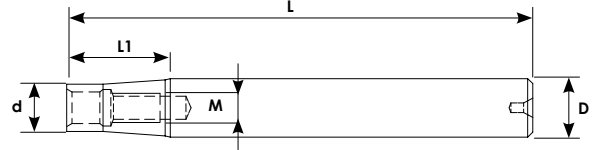

Sipariş Kodu Order Code Best.-Nr.	Stok/Stock/Lager	Ürün Kodu Product Code Produkt-Code	Ölçüler (mm) Dimensions(mm) Abmessungen (mm)				
			D	d	L	L1	M
VT500	●	D15-L150 M08 VIDALI TAKIM TUTUCU	15	12,7	150	30	M8
VT502	●	D16-L100 M08 VIDALI TAKIM TUTUCU	16	14	100	30	M8
VT504	●	D16-L150 M8 VIDALI TAKIM TUTUCU	16	14	150	30	M8
VT506	●	D19-L150 M10 VIDALI TAKIM TUTUCU	19	17,7	150	30	M10
VT508	●	D20-L100 M10 VIDALI TAKIM TUTUCU	20	17,7	100	30	M10
VT510	●	D20-L150 M10 VIDALI TAKIM TUTUCU	20	17,7	150	40	M10
VT512	●	D24-L150 M12 VIDALI TAKIM TUTUCU	24	20,7	150	40	M12
VT514	●	D25-L150 M12 VIDALI TAKIM TUTUCU	25	20,7	150	40	M12
VT516	●	D25-L200 M12 VIDALI TAKIM TUTUCU	25	20,7	200	40	M12
VT518	●	D25-L250 M12 VIDALI TAKIM TUTUCU	25	20,7	250	40	M12
VT520	●	D32-L170 M16 VIDALI TAKIM TUTUCU	32	28,7	170	40	M16
VT522	●	D32-L220 M16 VIDALI TAKIM TUTUCU	32	28,7	220	40	M16
VT524	●	D32-L300 M16 VIDALI TAKIM TUTUCU	32	28,7	300	40	M16



V1 APKT 1003

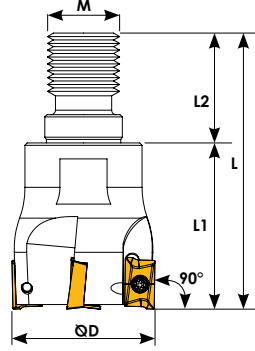

Ölçüler (mm) Dimensions (mm) Abmessungen (mm)		AP-- 1003	
L	S		
10,5	3,52		

Sipariş Kodu Order Code Best.-Nr.	Stok/Stock/Lager	Ürün Kodu Product Code Produkt-Code	Ölçüler (mm) Dimensions (mm) Abmessungen (mm)						Kullanılan Uç Insert WSP	Sıkma Cıvatası Clamp Screw Torx-Schraube	Anahtar Torx Key Torx-Schlüssel
			ØD	Z	M	L	L1	L2			
VT136	●	D16 Z02 M08 AP--10	16	2	M08	41	25	16	AP-- 1003 KRLY	TC060 M2,5x5,5	T8
VT138	●	D20 Z03 M10 AP--10	20	3	M10	55	35	20			
VT140	●	D25 Z03 M12 AP--10	25	3	M12	55	33	22			
VT143	●	D32 Z04 M16 AP--10	32	4	M16	60	35,5	24,5			
VT146	●	D35 Z04 M16 AP--10	35	4	M16	60	35,5	24,5			
VT148	●	D40 Z05 M16 AP--10	40	5	M16	60	35,5	24,5			
VT150	●	D42 Z05 M16 AP--10	42	5	M16	60	35,5	24,5			

V2 APKT 1604

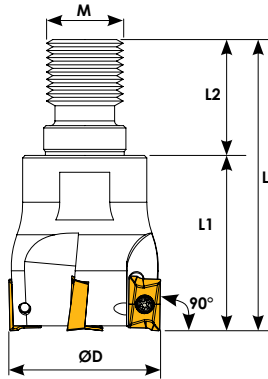

Ölçüler (mm) Dimensions (mm) Abmessungen (mm)		AP-- 1604	
L	S		
16,40	4,76		

Sipariş Kodu Order Code Best.-Nr.	Stok/Stock/Lager	Ürün Kodu Product Code Produkt-Code	Ölçüler (mm) Dimensions (mm) Abmessungen (mm)						Kullanılan Uç Insert WSP	Sıkma Cıvatası Clamp Screw Torx-Schraube	Anahtar Torx Key Torx-Schlüssel
			ØD	Z	M	L	L1	L2			
VT160	●	D25 Z02 M12 AP--16	25	2	M12	55	33	22	AP-- 1604 KRLY	TC074 M4x10	T15
VT163	●	D32 Z03 M16 AP--16	32	3	M16	60	35,5	24,5			
VT166	●	D35 Z03 M16 AP--16	35	3	M16	60	35,5	24,5			
VT168	●	D40 Z04 M16 AP--16	40	4	M16	60	35,5	24,5			
VT170	●	D42 Z04 M16 AP--16	42	4	M16	60	35,5	24,5			

KRLY ucuna uygundur. / Compatible with KRLY insert. / Kompatible für KRLY WP

V3
APMT 0903

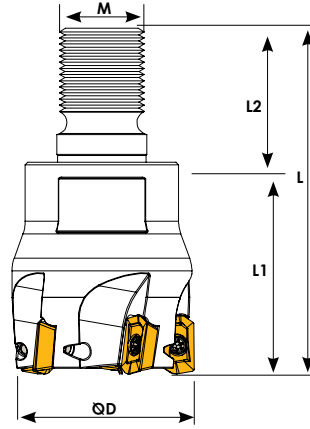

Ölçüler (mm) Dimensions(mm) Abmessungen (mm)			APMT 0903	
l	s	d		
9,4	3,6	6,21		

Sipariş Kodu Order Code Best.-Nr.	Stok/Stoek/Lager	Ürün Kodu Product Code Produkt-Code	Ölçüler (mm) Dimensions(mm) Abmessungen (mm)						Kullanılan Uç Insert WSP	Sıkma Cıvatası Clamp Screw Torx-Schraube	Anahtar Torx Key Torx-Schlüssel
			ØD	Z	M	L	L1	L2			
VT224	●	D16 Z02 M08 AP--09	16	2	M08	41	16	25			
VT225	●	D20 Z03 M10 AP--09	20	3	M10	48	18	30			
VT226	●	D25 Z04 M12 AP--09	25	4	M12	57	22	35			
VT227	●	D32 Z05 M16 AP--09	32	5	M16	65,3	25,3	40			
VT228	●	D35 Z05 M16 AP--09	35	5	M16	65,3	25,3	40			
VT229	●	D40 Z05 M16 AP--09	40	6	M16	65,3	25,3	40			
			APMT 0903 KRLY								

KRLY ucuna uygundur. / Compatible with KRLY insert. / Kompatible für KRLY WP

V4
BLMP 0603

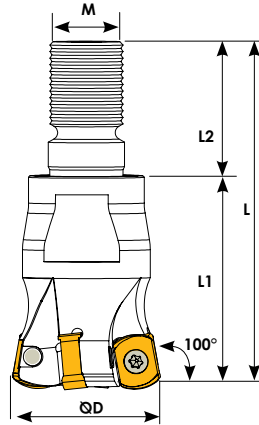

Ölçüler (mm) Dimensions(mm) Abmessungen (mm)			BLMP 0603	
d	l	s		
6,39	9	3,73		

Sipariş Kodu Order Code Best.-Nr.	Stok/Stoek/Lager	Ürün Kodu Product Code Produkt-Code	Ölçüler (mm) Dimensions(mm) Abmessungen (mm)						Kullanılan Uç Insert WSP	Sıkma Cıvatası Clamp Screw Torx-Schraube	Anahtar Torx Key Torx-Schlüssel
			ØD	Z	M	L	L1	L2			
VT190	●	D16 Z02 M08 BL--06	16	2	M08	41	25	16			
VT191	●	D20 Z03 M10 BL--06	20	3	M10	48	30	18			
VT192	●	D25 Z04 M12 BL--06	25	4	M12	57	35	22			
VT193	●	D32 Z05 M16 BL--06	32	5	M16	65,3	40	25,3			
VT194	●	D35 Z05 M16 BL--06	35	5	M16	65,3	40	25,3			
VT195	●	D40 Z06 M16 BL--06	40	6	M16	68,3	43	25,3			
VT196	●	D42 Z06 M16 BL--06	42	6	M16	68,3	43	25,3			
			BLMP 0603 TGTC								

TGTCucuna uygundur. / Compatible with TGTCinsert. / Kompatible für TGTCWP

**V5
ADMX 0702**

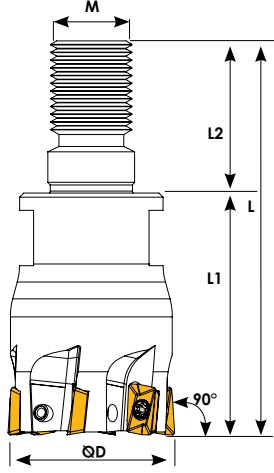

Ölçüler (mm) Dimensions (mm) Abmessungen (mm)		ADMX 0702	
L	S	L	
7,28	2,57	L	

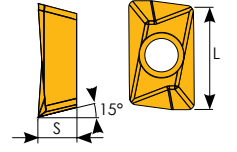

Sipariş Kodu Order Code Best.-Nr.	Stok/Stock/Lager	Ürün Kodu Product Code Produkt-Code	Ölçüler (mm) Dimensions (mm) Abmessungen (mm)						Kullanılan Uç Insert WSP	Sıkma Cıvatası Clamp Screw Torx-Schraube	Anahtar Torx Key Torx-Schlüssel
			ØD	Z	M	L	L1	L2			
VT200	●	D16 Z04 M08 AD--07	16	4	M08	41	23	18	ADMX 0702 PRMT	TC058 M2x4,2	T6
VT201	●	D20 Z05 M10 AD--07	20	5	M10	49	30	19			
VT202	●	D25 Z06 M12 AD--07	25	6	M12	57	35	22			
VT203	●	D32 Z08 M16 AD--07	32	8	M16	66	43	23			

PRMT ucuna uygundur. / Compatible with PRMT insert. / Kompatibel für PRMT WP

**V6
SDMT 09T3**

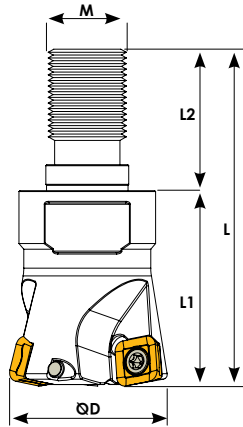

Ölçüler (mm) Dimensions (mm) Abmessungen (mm)		SDMT 09T3	
L	S	L	
9,52	3,18	L	

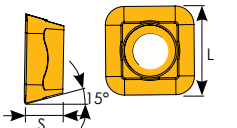

Sipariş Kodu Order Code Best.-Nr.	Stok/Stock/Lager	Ürün Kodu Product Code Produkt-Code	Ölçüler (mm) Dimensions (mm) Abmessungen (mm)						Kullanılan Uç Insert WSP	Sıkma Cıvatası Clamp Screw Torx-Schraube	Anahtar Torx Key Torx-Schlüssel
			ØD	Z	M	L	L1	L2			
VT240	●	D32 Z03 M16 SD--09	32	3	M16	60	36	24	SDMT 09T3 ZCC	TC067 M3,5x9	T15
VT241	●	D35 Z03 M16 SD--09	35	3	M16	60	36	24			
VT242	●	D40 Z04 M16 SD--09	40	3	M16	60	36	24			

ZCC ucuna uygundur. / Compatible with ZCC insert. / Kompatibel für ZCC WP

V7
RPMT 10

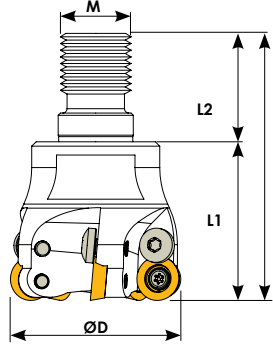

Ölçüler (mm) Dimensions(mm) Abmessungen (mm)		RPMT 10T3	
d	S		
10	3,97		

Sipariş Kodu Order Code Best.-Nr.	Stok/Stock/Lager	Ürün Kodu Product Code Produkt-Code	Ölçüler (mm) Dimensions(mm) Abmessungen (mm)						Kullanılan Uç Insert WSP	Baskı Cıvatası Locking Screw Verriegelungs Schraube	Sıkma Cıvatası Clamp Screw Torx-Schraube	Anahtar Torx Key Torx-Schlüssel
			ØD	Z	M	L	L1	L2				
VT180	●	D25 Z03 M12 RP--10	25	3	M12	55	33	22				
VT182	●	D32 Z03 M16 RP--10	32	3	M16	68	36	24,5				
									RPMT 10 MTSBSH	TC040 M3,5	TC067 M3,5x9	T15

V8
RPMT 12

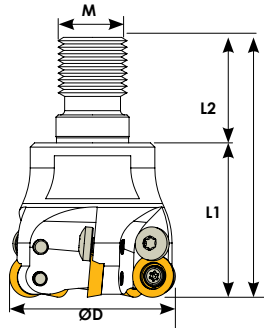

Ölçüler (mm) Dimensions(mm) Abmessungen (mm)		RPMT 1204	
d	S		
12	4,76		

Sipariş Kodu Order Code Best.-Nr.	Stok/Stock/Lager	Ürün Kodu Product Code Produkt-Code	Ölçüler (mm) Dimensions(mm) Abmessungen (mm)						Kullanılan Uç Insert WSP	Baskı Cıvatası Locking Screw Verriegelungs Schraube	Sıkma Cıvatası Clamp Screw Torx-Schraube	Anahtar Torx Key Torx-Schlüssel
			ØD	Z	M	L	L1	L2				
VT174	●	D25 Z02 M12 RP--12	25	2	M12	55	33	22				
VT176	●	D32 Z03 M16 RP--12	32	3	M16	60	34,7	25,3				
									RPMT 12 MTSBSH	TC040 M3,5	TC067 M3,5x9	T15

MTSBSH ucuna uygundur. / Compatible with MTSBSH insert. / Kompatible für MTSBSH WP

RDMT 1003

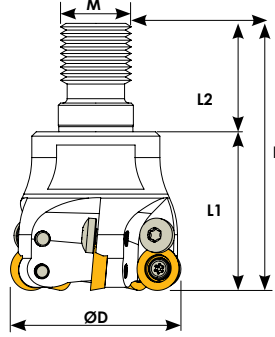

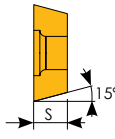
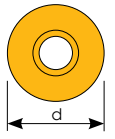
Ölçüler (mm) Dimensions (mm) Abmessungen (mm)		RDMT 1003	
d	S		
10	3,18		

Sipariş Kodu Order Code Best.-Nr.	Stok/Stock/Lager	Ürün Kodu Product Code Produkt-Code	Ölçüler (mm) Dimensions (mm) Abmessungen (mm)						Kullanılan Uç Insert WSP	Baskı Cıvatası Locking Screw Verriegelungs Schraube	Sıkma Cıvatası Clamp Screw Torx-Schraube	Anahtar Torx Key Torx-Schlüssel
			ØD	Z	M	L	L1	L2				
VT098	●	D20 Z02 M10 RD--10	20	2	M10	55	35	20	RD-- 1003 ISO	TC040 M3,5	TC067 M3,5x9	T15
VT100	●	D25 Z03 M12 RD--10	25	3	M12	55	33	22				
VT103	●	D32 Z03 M16 RD--10	32	3	M16	60	35,5	24,5				
VT106	●	D35 Z04 M16 RD--10	35	4	M16	60	35,5	24,5				
VT107	●	D35 Z05 M16 RD--10	35	5	M16	60	35,5	24,5				
VT108	●	D40 Z05 M16 RD--10	40	5	M16	60	35,5	24,5				
VT110	●	D42 Z05 M16 RD--10	42	5	M16	60	35,5	24,5				

RDMT 1003 ISO'dur./ RDMT 1003 is ISO. / Kompatible für ISO WP

RDMT 12T3

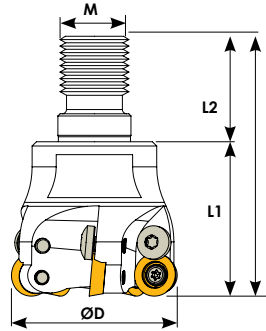

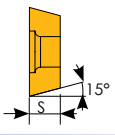
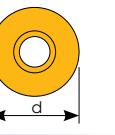
Ölçüler (mm) Dimensions (mm) Abmessungen (mm)		RDMT 12T3	
d	S		
12	3,97		

Sipariş Kodu Order Code Best.-Nr.	Stok/Stock/Lager	Ürün Kodu Product Code Produkt-Code	Ölçüler (mm) Dimensions (mm) Abmessungen (mm)						Kullanılan Uç Insert WSP	Baskı Cıvatası Locking Screw Verriegelungs Schraube	Sıkma Cıvatası Clamp Screw Torx-Schraube	Anahtar Torx Key Torx-Schlüssel
			ØD	Z	M	L	L1	L2				
VT120	●	D25 Z02 M12 RD--12	25	2	M12	55	33	22	RDMT 12T3 ISO	TC040 M3,5	TC067 M3,5x9	T15
VT123	●	D32 Z03 M16 RD--12	32	3	M16	60	35,5	24,5				
VT126	●	D35 Z03 M16 RD--12	35	3	M16	60	35,5	24,5				
VT128	●	D40 Z04 M16 RD--12	40	4	M16	60	35,5	24,5				
VT130	●	D42 Z04 M16 RD--12	42	4	M16	60	35,5	24,5				

RDMT 12T3 ISO'dur./ RDMT 12T3 is ISO. / Kompatible für ISO WP

V9
APKT 11T3 R390

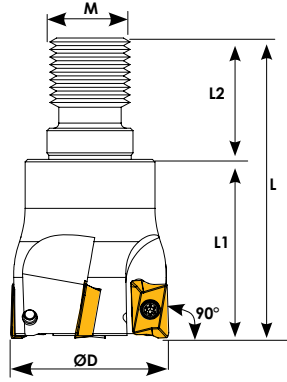

Ölçüler (mm) Dimensions (mm) Abmessungen (mm)		APKT 11T3 R390	
L	S		
11	3,18		

Sipariş Kodu Order Code Best.-Nr.	Stok/Stock/Lager	Ürün Kodu Product Code Produkt-Code	Ölçüler (mm) Dimensions (mm) Abmessungen (mm)						Kullanılan Uç Insert WSP	Sıkma Cıvatası Clamp Screw Torx-Schraube	Anahtar Torx Key Torx-Schlüssel
			ØD	Z	M	L	L1	L2			
VT210	●	D16 Z02 M08 AP--11	16	2	M08	55	33	17	APKT 11T3 R390 SNDVK	TC063 M2,5x7	T8
VT211	●	D20 Z03 M10 AP--11	20	3	M10	55	33	17			
VT212	●	D25 Z03 M12 AP--11	25	3	M12	55	33	22			
VT213	●	D32 Z03 M16 AP--11	32	3	M16	60	36	24			

SNDVK ucuna uygundur. / Compatible with SNDVK insert. / Kompatible für SNDVK WP

V10
XOMX 1204

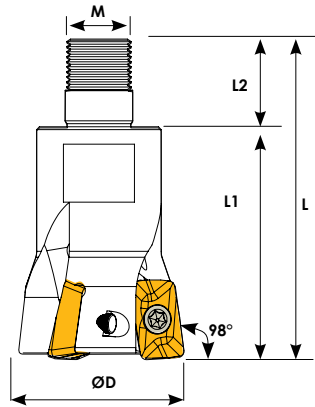

Ölçüler (mm) Dimensions (mm) Abmessungen (mm)		XO-- 1204	
L	S		
12	5,06		

Sipariş Kodu Order Code Best.-Nr.	Stok/Stock/Lager	Ürün Kodu Product Code Produkt-Code	Ölçüler (mm) Dimensions (mm) Abmessungen (mm)						Kullanılan Uç Insert WSP	Sıkma Cıvatası Clamp Screw Torx-Schraube	Anahtar Torx Key Torx-Schlüssel
			ØD	Z	M	L	L1	L2			
VT220	●	D24,6 Z02 M10 XO--12	24,6	2	M10	59	40	19	XO-- 1204 SCO	TC069 M3,5x8,5	T10
VT222	●	D31,6 Z03 M12 XO--12	31,6	3	M12	62	40	22			

SCO ucuna uygundur. / Compatible with SCO insert. / Kompatible für KRLY WP

V11
EPMT 0603

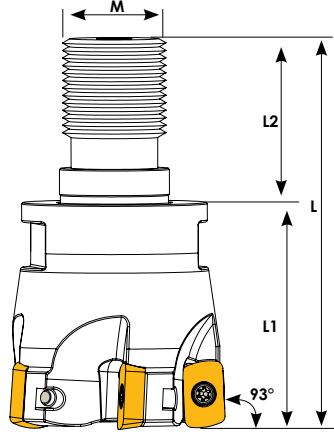

Ölçüler (mm) Dimensions (mm) Abmessungen (mm)		EPMT 0603	
l	s		
10	3,18		

Sipariş Kodu Order Code Best.-Nr.	Stok/Stock/Lager	Ürün Kodu Product Code Produkt-Code	Ölçüler (mm) Dimensions (mm) Abmessungen (mm)							Kullanılan Uç Insert WSP	Sıkma Cıvatası Clamp Screw Torx-Schraube	Anahtar Torx Key Torx-Schlüssel
			ØD	Z	M	L	L1	L2				
VT230	●	D16 Z02 M08 EP--06	16	2	M08	41	16	25	EPMT 0603 HTCH			
VT231	●	D20 Z03 M10 EP--06	20	3	M10	48	18	30				
VT232	●	D25 Z04 M12 EP--06	25	4	M12	55	20	35				
VT233	●	D32 Z05 M16 EP--06	32	5	M16	60	25,3	34,7				
VT234	●	D35 Z05 M16 EP--06	35	5	M16	60	25,3	34,7				
VT235	●	D40 Z06 M16 EP--06	40	6	M16	60	25,3	34,7				
VT236	●	D42 Z06 M16 EP--06	42	6	M16	65,3	25,3	40				

HTCH ucuna uygundur. / Compatible with HTCH insert. / Kompatible für HTCH WP



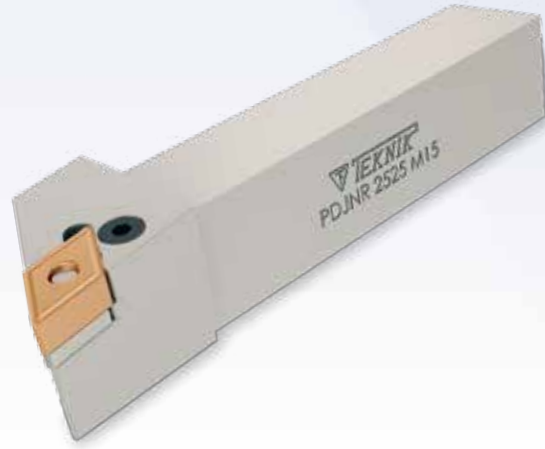

P-AP Sistem Kater
P-AP System

93° PDJNR

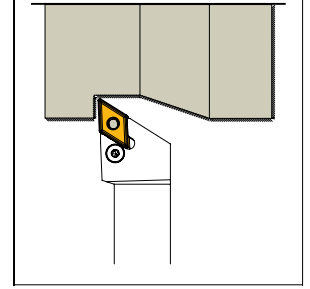
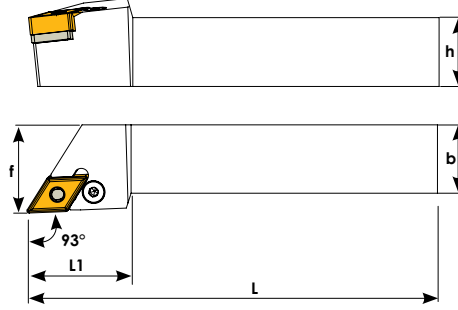

Sipariş Kodu Order Code Best.-Nr.	Stok/Stock/Lager	Ürün Kodu Product Code Produkt-Code	Ölçüler (mm) Dimensions(mm) Abmessungen (mm)					Kullanılan Uç Insert WSP	Sıkma Cıvatası Clamp Screw Klemm-Schraube	Aflık Shim U-Platte	Levyeye Sacı Lock Pin Rohrstift	Levyeye Lever Kniehebel	Anahtar Allen Key Inbus-Schlüssel
			L	L1	h	f	b						
P110	●	PDJNR 2020 K15	125	35	20	25	20						
P112	●	PDJNR 2525 M15	150	38	25	32	25						
P114	●	PDJNR 3232 P15	170	38	32	40	32						

93° PDJNL

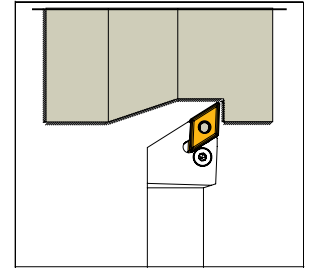
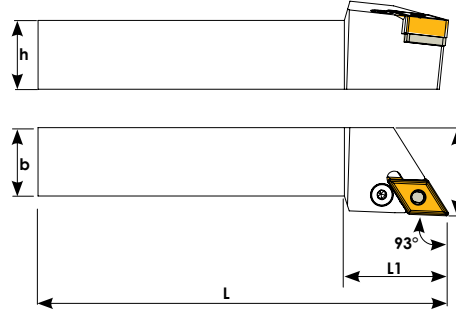

Sipariş Kodu Order Code Best.-Nr.	Stok/Stock/Lager	Ürün Kodu Product Code Produkt-Code	Ölçüler (mm) Dimensions(mm) Abmessungen (mm)					Kullanılan Uç Insert WSP	Sıkma Cıvatası Clamp Screw Klemm-Schraube	Aflık Shim U-Platte	Levyeye Sacı Lock Pin Rohrstift	Levyeye Lever Kniehebel	Anahtar Allen Key Inbus-Schlüssel
			L	L1	h	f	b						
P122	●	PDJNL 2020 K15	125	35	20	25	20						
P124	●	PDJNL 2525 M15	150	38	25	32	25						
P126	●	PDJNL 3232 P15	170	38	32	40	32						

95° PCLNR

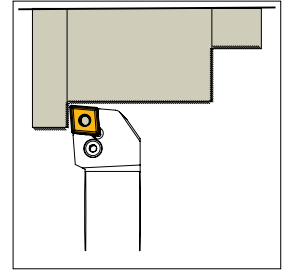
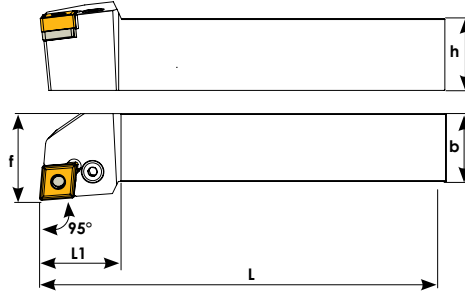

Sipariş Kodu Order Code Best.-Nr.	Stok/Stock/Lager	Ürün Kodu Product Code Produkt-Code	Ölçüler (mm) Dimensions(mm) Abmessungen (mm)					Kullanılan Uç Insert WSP	Sıkma Civatası Clamp Screw Klemm-Schraube	Altlık Shim U-Platte	Levy Sacı Lock Pin Rohrstift	Levy Lever Kniehebel	Anahtar Allen Key Inbuss-Schlüssel
			L	L1	h	f	b						
P129	●	PCLNR 1616 H12	100	30	16	20	16	CNMG 1204	TH818 M8	TA016-1	TS4	TL4	3 Allen
P130	●	PCLNR 2020 K12	125	30	20	25	20	CNMG 1204	TH821 M8	TA016-1	TS4	TL4	
P132	●	PCLNR 2525 M12	150	30	25	32	25						
P134	●	PCLNR 3232 P12	170	30	32	40	32						

95° PCLNL

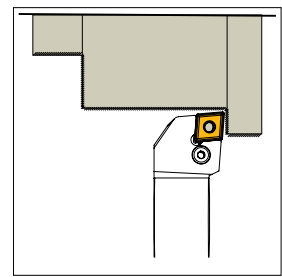
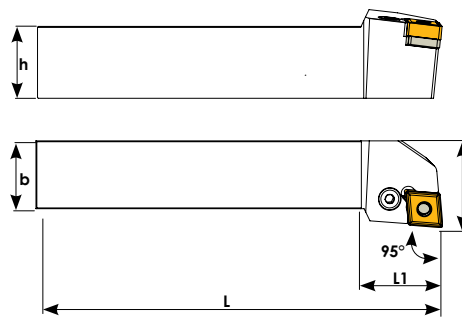

Sipariş Kodu Order Code Best.-Nr.	Stok/Stock/Lager	Ürün Kodu Product Code Produkt-Code	Ölçüler (mm) Dimensions(mm) Abmessungen (mm)					Kullanılan Uç Insert WSP	Sıkma Civatası Clamp Screw Klemm-Schraube	Altlık Shim U-Platte	Levy Sacı Lock Pin Rohrstift	Levy Lever Kniehebel	Anahtar Allen Key Inbuss-Schlüssel
			L	L1	h	f	b						
P139	●	PCLNL 1616 H12	100	30	16	20	16	CNMG 1204	TH 818 M8	TA016-1	TS4	TL4	3 Allen
P140	●	PCLNL 2020 K12	125	30	20	25	20	CNMG 1204	TH821 M8	TA016-1	TS4	TL4	
P142	●	PCLNL 2525 M12	150	30	25	32	25						
P144	●	PCLNL 3232 P12	170	30	32	40	32						

95° PWLNR 08

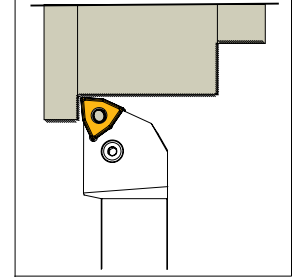
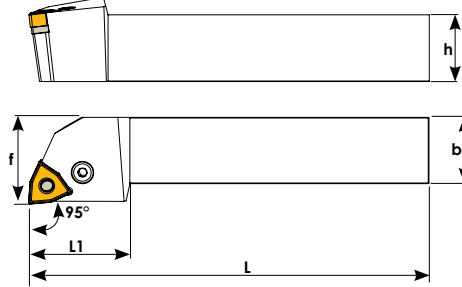

Sipariş Kodu Order Code Best.-Nr.	Stok/Stock/Lager	Ürün Kodu Product Code Produkt-Code	Ölçüler (mm) Dimensions (mm) Abmessungen (mm)					Kullanılan Uç Insert WSP	Sıkma Civatası Clamp Screw Klemm Schraube	Aflık Shim U-Platte	Levyé Sacı Lock Pin Rohrstift	Levyé Lever Kniehebel	Anahtar Allen Key Inbuss-Schlüssel
			L	L1	h	f	b						
P150	●	PWLNR 2020 K08	125	30	20	25	20	WNMG 0804	TH-821 M8	TA020-1	TS4	TL4	3 Allen
P151	●	PWLNR 2525 M08	150	38	25	32	25						
P152	●	PWLNR 3232 P08	170	38	32	40	32						

95° PWLNL 08

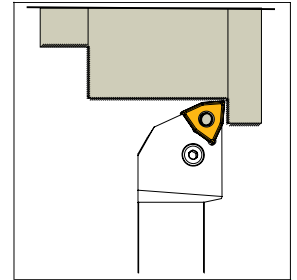
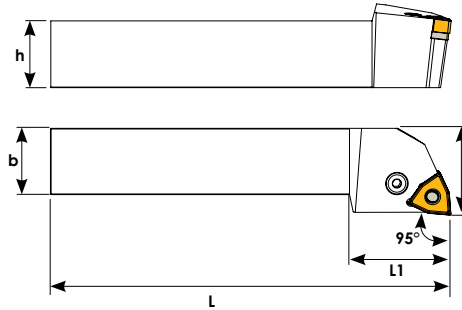

Sipariş Kodu Order Code Best.-Nr.	Stok/Stock/Lager	Ürün Kodu Product Code Produkt-Code	Ölçüler (mm) Dimensions (mm) Abmessungen (mm)					Kullanılan Uç Insert WSP	Sıkma Civatası Clamp Screw Klemm-Schraube	Aflık Shim U-Platte	Levyé Sacı Lock Pin Rohrstift	Levyé Lever Kniehebel	Anahtar Allen Key Inbuss-Schlüssel
			L	L1	h	f	b						
P155	●	PWLNL 2020 K08	125	30	20	25	20	WNMG 0804	TH-821 M8	TA020-1	TS4	TL4	3 Allen
P156	●	PWLNL 2525 M08	150	38	25	32	25						
P157	●	PWLNL 3232 P08	170	38	32	40	32						

95° PWLNR 06

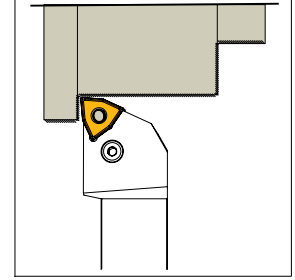
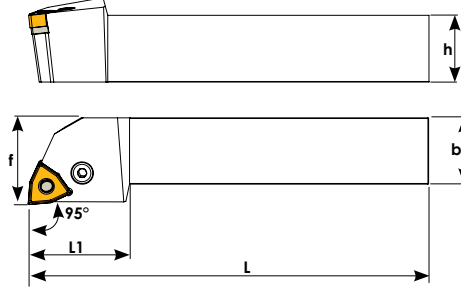

Sipariş Kodu Order Code Best.-Nr.	Stok/Stock/Lager	Ürün Kodu Product Code Produkt-Code	Ölçüler (mm) Dimensions (mm) Abmessungen (mm)					Kullanılan Uç Insert WSP	Sıkma Civatası Clamp Screw Klemm-Schraube	Altlık Shim U-Platte	Levyeye Sacı Lock Pin Rohrstift	Levyeye Lever Kniehebel	Anahtar Allen Key Inbuss-Schlüssel
			L	L1	h	f	b						
P158	●	PWLNR 1616 H06	100	30	16	20	16	WNGM 0604	TH-617 M6	TA021	TS3	TL3	2,5 Allen
P160	●	PWLNR 2020 K06	125	30	20	25	20						
P161	●	PWLNR 2525 M06	150	30	25	32	25						

95° PWLNL 06

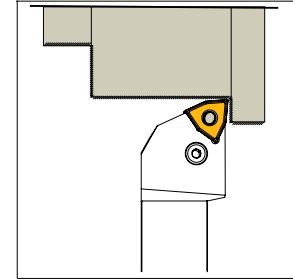
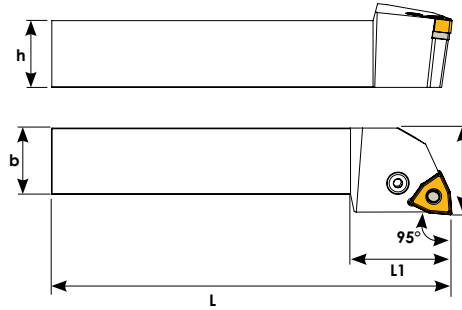

Sipariş Kodu Order Code Best.-Nr.	Stok/Stock/Lager	Ürün Kodu Product Code Produkt-Code	Ölçüler (mm) Dimensions (mm) Abmessungen (mm)					Kullanılan Uç Insert WSP	Sıkma Civatası Clamp Screw Klemm-Schraube	Altlık Shim U-Platte	Altlık Pimi Lock Pin Rohrstift	Levyeye Lever Kniehebel	Anahtar Allen Key Inbuss-Schlüssel
			L	L1	h	f	b						
P164	●	PWLNL 1616 H06	100	30	16	20	16	WNGM 0604	TH-617 M6	TA021	TS3	TL3	2,5 Allen
P165	●	PWLNL 2020 K06	125	30	20	25	20						
P166	●	PWLNL 2525 M06	150	30	25	32	25						

93° PDUNR

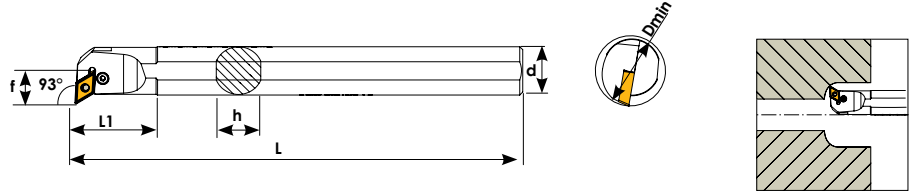

Sipariş Kodu Order Code Best.-Nr.	Stok/Stock/Lager	Ürün Kodu Product Code Produkt-Code	Ölçüler (mm) Dimensions(mm) Abmessungen (mm)						Kullanılan U Insert WSP	Sıkma Cıvatası Clamp Screw Klemm- Schraube	Altlık Shim U-Platte	Levyeye Sacı Lock Pin Rohrstift	Levyeye Lever Kniehebel	Anahtar Allen Key Inbuss-Schlüssel
			Dmin	d	L	L1	f	h						
P300	●	S25S PDUNR 15	32	25	250	50	17	23	DNMG 1506	TH6134A M6	---	---	TL4A	2,5 Allen
P302	●	S32T PDUNR 15	40	32	300	55	22	30		TH822 M8	TA014-1	TS-4	TL4B	3 Allen
P304	●	S40T PDUNR 15	50	40	300	55	27	38						

93° PDUNL

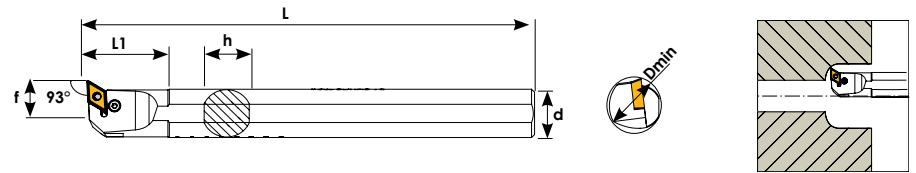

Sipariş Kodu Order Code Best.-Nr.	Stok/Stock/Lager	Ürün Kodu Product Code Produkt-Code	Ölçüler (mm) Dimensions(mm) Abmessungen (mm)						Kullanılan U Insert WSP	Sıkma Cıvatası Clamp Screw Klemm- Schraube	Altlık Shim U-Platte	Levyeye Sacı Lock Pin Rohrstift	Levyeye Lever Kniehebel	Anahtar Allen Key Inbuss-Schlüssel
			Dmin	d	L	L1	f	h						
P310	●	S25S PDUNL 15	32	25	250	50	17	23	DNMG 1506	TH6134A M6	---	---	TL4A	2,5 Allen
P312	●	S32T PDUNL 15	40	32	300	55	22	30		TH822 M8	TA014-1	TS-4	TL4B	3 Allen
P314	●	S40T PDUNL 15	50	40	300	55	27	38						

95° PCLNR

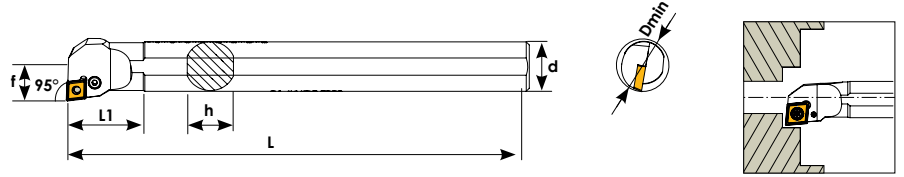

Sipariş Kodu Order Code Best.-Nr.	Stok/Stock/Lager	Ürün Kodu Product Code Produkt-Code	Ölçüler (mm) Dimensions (mm) Abmessungen (mm)						Kullanılan Uç Insert WSP	Sıkma Cıvatası Clamp Screw Klemm-Schraube	Aftlık Shim U-Platte	Levye Sacı Lock Pin Rohrstift	Levye Lever Kniehebel	Anahtar Allen Key Inbuss-Schlüssel
			Dmin	d	L	L1	f	h						
P340	●	S25S PCLNR 12	32	25	250	50	17	23	CNMG 1204	TH6134A M6	---	---	TL4A	2,5 Allen
P342	●	S32T PCLNR 12	40	32	300	50	22	30		TH821 M8	TA016-1	TS-4	TL4	3 Allen
P344	●	S40T PCLNR 12	50	40	300	55	27	38						

95° PCLNL

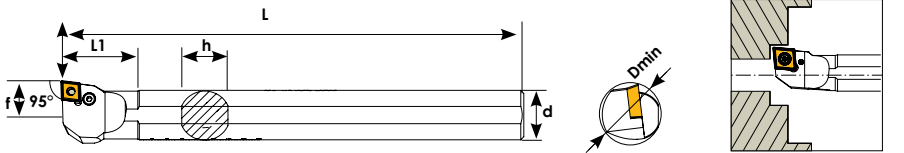

Sipariş Kodu Order Code Best.-Nr.	Stok/Stock/Lager	Ürün Kodu Product Code Produkt-Code	Ölçüler (mm) Dimensions (mm) Abmessungen (mm)						Kullanılan Uç Insert WSP	Sıkma Cıvatası Clamp Screw Klemm-Schraube	Aftlık Shim U-Platte	Levye Sacı Lock Pin Rohrstift	Levye Lever Kniehebel	Anahtar Allen Key Inbuss-Schlüssel
			Dmin	d	L	L1	f	h						
P350	●	S25S PCLNL 12	32	25	250	50	17	23	CNMG 1204	TH6134A M6	---	---	TL4A	2,5 Allen
P352	●	S32T PCLNL 12	40	32	300	50	22	30		TH821 M8	TA016-1	TS-4	TL4	3 Allen
P354	●	S40T PCLNL 12	50	40	300	55	27	38						

95° PWLNR 08

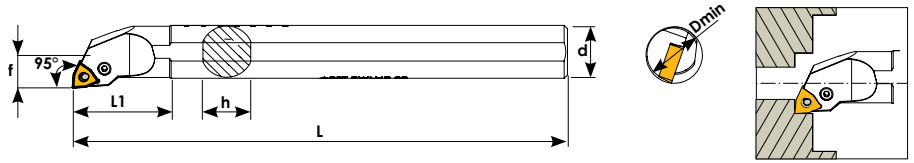

Sipariş Kodu Order Code Best.-Nr.	Stok/Stock/Lager	Ürün Kodu Product Code Produkt-Code	Ölçüler (mm) Dimensions (mm) Abmessungen (mm)						Kullanılan Uç Insert WSP	Sıkma Cıvatası Clamp Screw Klemm-Schraube	Aflık Shim U-Platte	Levye Sacı Lock Pin Rohrstift	Levye Lever Kniehebel	Anahtar Allen Key Inbuss-Schlüssel
			Dmin	d	L	L1	f	h						
P360	●	S25S PWLNR 08	32	25	250	50	17	23	WNUMG 0804	TH6134A M6	---	---	TL4A	2,5 Allen
P362	●	S32T PWLNR 08	40	32	300	60	22	30		TH821 M8	TA020-1	TS-4	TL4	3 Allen
P364	●	S40T PWLNR 08	50	40	300	60	27	38						

95° PWLNL 08

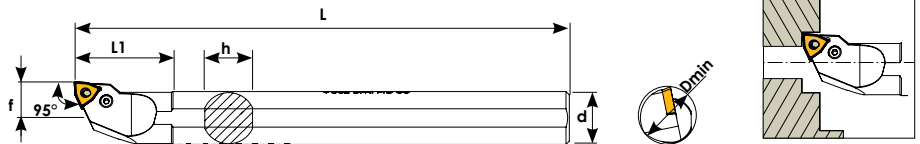
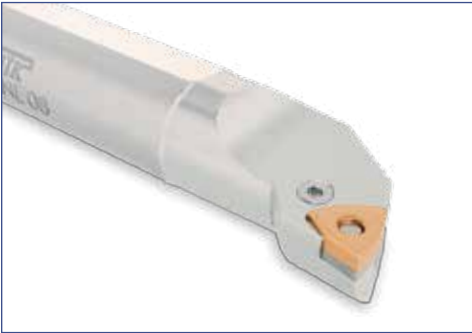

Sipariş Kodu Order Code Best.-Nr.	Stok/Stock/Lager	Ürün Kodu Product Code Produkt-Code	Ölçüler (mm) Dimensions (mm) Abmessungen (mm)						Kullanılan Uç Insert WSP	Sıkma Cıvatası Clamp Screw Klemm-Schraube	Aflık Shim U-Platte	Levye Sacı Lock Pin Rohrstift	Levye Lever Kniehebel	Anahtar Allen Key Inbuss-Schlüssel
			Dmin	d	L	L1	f	h						
P370	●	S25S PWLNL 08	32	25	250	50	17	23	WNUMG 0804	TH6134A M6	---	---	TL4A	2,5 Allen
P372	●	S32T PWLNL 08	40	32	300	60	22	30		TH821 M8	TA020-1	TS-4	TL4	3 Allen
P374	●	S40T PWLNL 08	50	40	300	60	27	38						

95° PWLNR 06

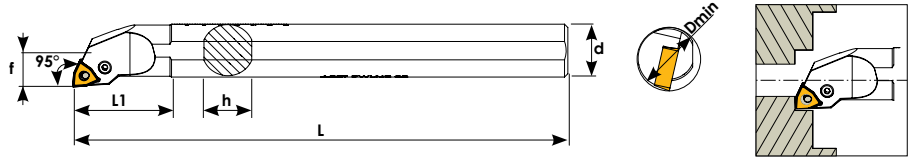
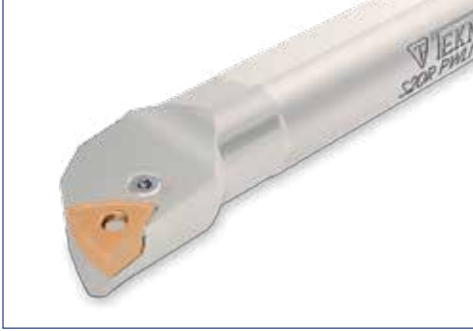

Sipariş Kodu Order Code Best.-Nr.	Stok/stock/Lager	Ürün Kodu Product Code Produkt-Code	Ölçüler (mm) Dimensions(mm) Abmessungen (mm)						Kullanılan Uç Insert WSP	Sıkma Civatası Clamp Screw Klemm-Schraube	Altlık Shim U-Platte	Levyeye Sacı Lock Pin Rohrstift	Levyeye Lever Kniehebel	Anahtar Allen Key Inbuss-Schlüssel
			Dmin	d	L	L1	f	h						
P380	●	S16R PWLNR 06	20	16	200	40	11	15	WNMG 0604	TH512 M5	TA021	TS3	TL3B	2 Allen
P382	●	S20R PWLNR 06	25	20	200	40	13	18						

95° PWLNL 06

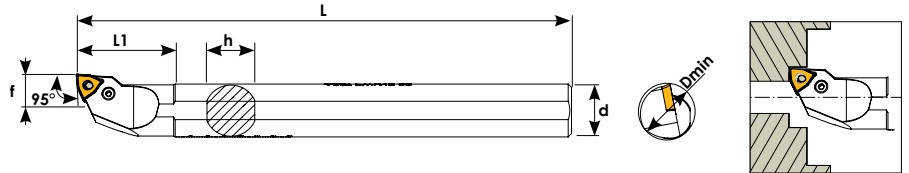
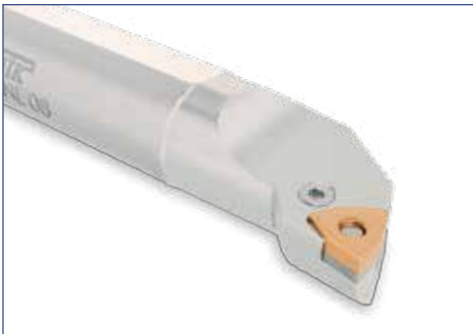

Sipariş Kodu Order Code Best.-Nr.	Stok/stock/Lager	Ürün Kodu Product Code Produkt-Code	Ölçüler (mm) Dimensions(mm) Abmessungen (mm)						Kullanılan Uç Insert WSP	Sıkma Civatası Clamp Screw Klemm-Schraube	Altlık Shim U-Platte	Levyeye Sacı Lock Pin Rohrstift	Levyeye Lever Kniehebel	Anahtar Allen Key Inbuss-Schlüssel
			Dmin	d	L	L1	f	h						
P388	●	S16R PWLNL 06	20	16	200	40	11	15	WNMG 0604	TH512 M5	TA021	TS3	TL3B	2 Allen
P390	●	S20R PWLNL 06	25	20	200	40	13	18						

**NEW
PRODUCT**

93° PDJNR

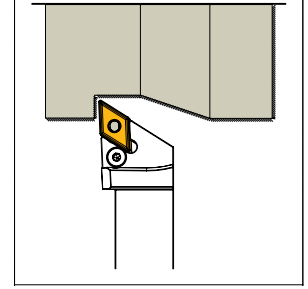
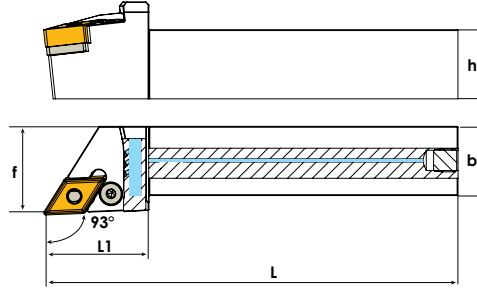
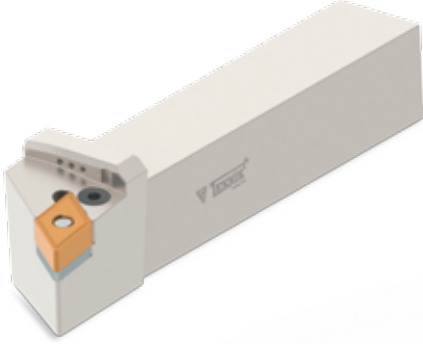

Sipariş Kodu Order Code Best.-Nr.	Stok/Stock/Lager	Ürün Kodu Product Code Produkt-Code	Ölçüler (mm) Dimensions(mm) Abmessungen (mm)					Kullanılan Uç Insert WSP	Sıkma Cıvatası Clamp Screw Klemm- Schraube	Altlık Shim U-Platte	Levyeye Sacı Lock Pin Rohrstift	Levyeye Lever Kniehebel	Anahtar Allen Key Inbuss-Schlüssel
			L	L1	h	f	b						
AP110	●	PDJNR 2020 K15	125	40	20	25	20						
AP112	●	PDJNR 2525 M15	150	40	25	32	25						

93° PDJNL

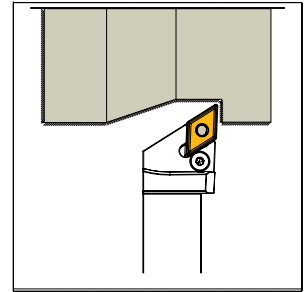
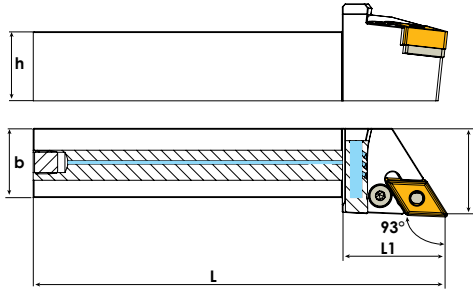

Sipariş Kodu Order Code Best.-Nr.	Stok/Stock/Lager	Ürün Kodu Product Code Produkt-Code	Ölçüler (mm) Dimensions(mm) Abmessungen (mm)					Kullanılan Uç Insert WSP	Sıkma Cıvatası Clamp Screw Klemm- Schraube	Altlık Shim U-Platte	Levyeye Sacı Lock Pin Rohrstift	Levyeye Lever Kniehebel	Anahtar Allen Key Inbuss-Schlüssel
			L	L1	h	f	b						
AP122	●	PDJNL 2020 K15	125	40	20	25	20						
AP124	●	PDJNL 2525 M15	150	40	25	32	25						

● Stokta / In Stock / Lager ○ Sınırlı Stok / Limited Stock / Begrenzte Lagerhaltung

95° PCLNR

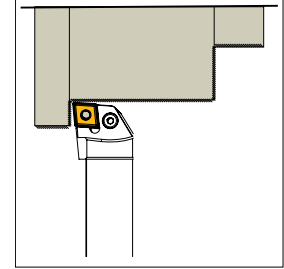
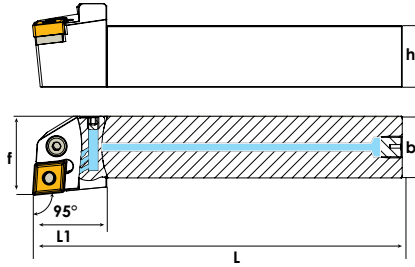
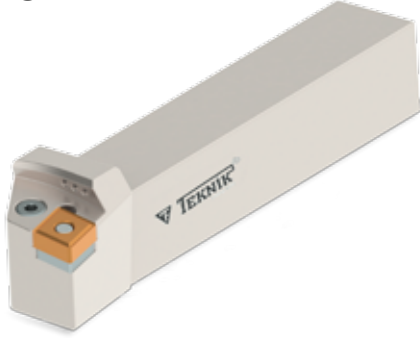

**NEW
PRODUCT**



Sipariş Kodu Order Code Best.-Nr.	Stok/Stock/Lager	Ürün Kodu Product Code Produkt-Code	Ölçüler (mm) Dimensions(mm) Abmessungen (mm)					Kullanılan Uç Insert WSP	Sıkma Civatası Clamp Screw Klemm-Schraube	Aftlık Shim U-Platte	Levyeye Sacı Lock Pin Rohrstift	Levyeye Lever Kniehebel	Anahtar Allen Key Inbuss-Schlüssel
			L	L1	h	f	b						
AP129	●	PCLNR 1616 H12	100	28	16	20	16	CNMG 1204	TH818 M8	TA016-1	TS4	TL4	3 Allen
AP130	●	PCLNR 2020 K12	125	28	20	25	20	CNMG 1204	TH821 M8	TA016-1	TS4	TL4	
AP132	●	PCLNR 2525 M12	150	30	25	32	25						

95° PCLNL

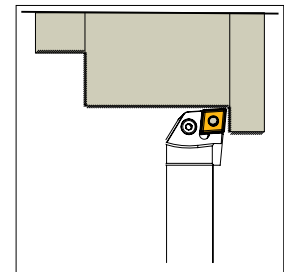
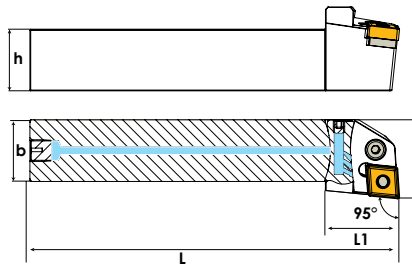
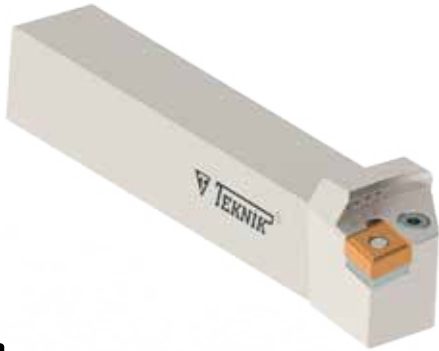

Sipariş Kodu Order Code Best.-Nr.	Stok/Stock/Lager	Ürün Kodu Product Code Produkt-Code	Ölçüler (mm) Dimensions(mm) Abmessungen (mm)					Kullanılan Uç Insert WSP	Sıkma Civatası Clamp Screw Klemm-Schraube	Aftlık Shim U-Platte	Levyeye Sacı Lock Pin Rohrstift	Levyeye Lever Kniehebel	Anahtar Allen Key Inbuss-Schlüssel
			L	L1	h	f	b						
AP139	●	PCLNL 1616 H12	100	28	16	20	16	CNMG 1204	TH 818 M8	TA016-1	TS4	TL4	3 Allen
AP140	●	PCLNL 2020 K12	125	28	20	25	20	CNMG 1204	TH821 M8	TA016-1	TS4	TL4	
AP142	●	PCLNL 2525 M12	150	30	25	32	25						

● Stokta / In Stock / Lager ○ Sınırlı Stok / Limited Stock / Begrenzte Lagerhaltung

95° PWLNR 08

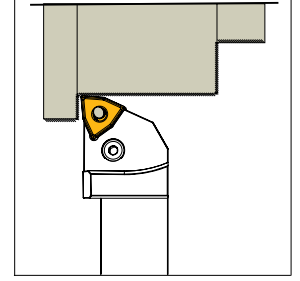
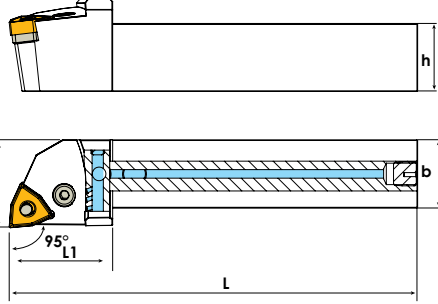

Sipariş Kodu Order Code Best.-Nr.	Stok/Stock/Lager	Ürün Kodu Product Code Produkt-Code	Ölçüler (mm) Dimensions(mm) Abmessungen (mm)					Kullanılan Uç Insert WSP	Sıkma Cıvatası Clamp Screw Klemm-Schraube	Altlık Shim U-Platte	Levyeye Sacı Lock Pin Rohrstift	Levyeye Lever Kniehebel	Anahtar Allen Key Inbuss-Schlüssel
			L	L1	h	f	b						
AP150	●	PWLNR 2020 K08	125	30	20	25	20	WNGM 0804	TH-821 M8	TA020-1	TS4	TL4	3 Allen
AP151	●	PWLNR 2525 M08	150	38	25	32	25						

95° PWLNL 08

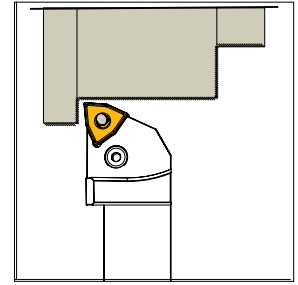
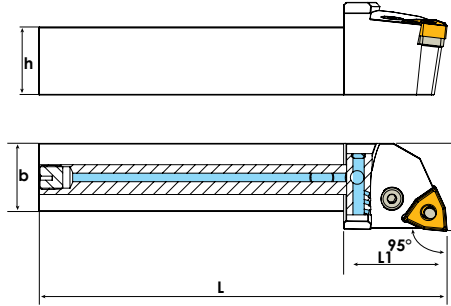

Sipariş Kodu Order Code Best.-Nr.	Stok/Stock/Lager	Ürün Kodu Product Code Produkt-Code	Ölçüler (mm) Dimensions(mm) Abmessungen (mm)					Kullanılan Uç Insert WSP	Sıkma Cıvatası Clamp Screw Klemm-Schraube	Altlık Shim U-Platte	Levyeye Sacı Lock Pin Rohrstift	Levyeye Lever Kniehebel	Anahtar Allen Key Inbuss-Schlüssel
			L	L1	h	f	b						
AP155	●	PWLNL 2020 K08	125	30	20	25	20	WNGM 0804	TH-821 M8	TA020-1	TS4	TL4	3 Allen
AP156	●	PWLNL 2525 M08	150	38	25	32	25						

● Stokta/ In Stock / Lager ○ Sınırlı Stok / Limited Stock / Begrenzte Lagerhaltung

95° PWLNR 06

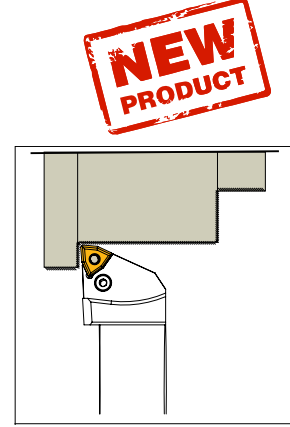
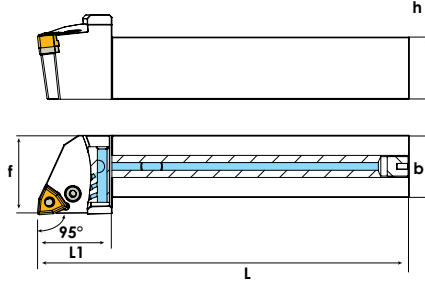

**NEW
PRODUCT**

Sipariş Kodu Order Code Best.-Nr.	Stok/Stock/Lager	Ürün Kodu Product Code Produkt-Code	Ölçüler (mm) Dimensions (mm) Abmessungen (mm)					Kullanılan Uç Insert WSP	Sıkma Cıvatası Clamp Screw Klemm-Schraube	Altılık Shim U-Platte	Levye Sacı Lock Pin Rohrstift	Levye Lever Kniehebel	Anahtar Allen Key Inbuss-Schlüssel
			L	L1	h	f	b						
AP158	●	PWLNR 1616 H06	100	30	16	20	16	WNGM 0604	TH-617 M6	TA021	TS3	TL3	2,5 Allen
AP160	●	PWLNR 2020 K06	125	30	20	25	20						
AP161	●	PWLNR 2525 M06	150	30	25	32	25						

95° PWLNL 06

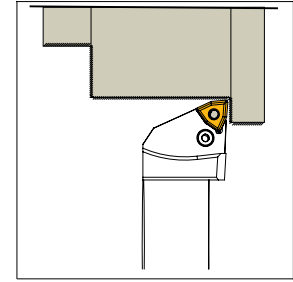
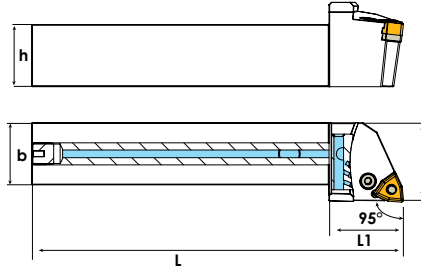

Sipariş Kodu Order Code Best.-Nr.	Stok/Stock/Lager	Ürün Kodu Product Code Produkt-Code	Ölçüler (mm) Dimensions (mm) Abmessungen (mm)					Kullanılan Uç Insert WSP	Sıkma Cıvatası Clamp Screw Klemm-Schraube	Altılık Shim U-Platte	Altılık Pimi Lock Pin Rohrstift	Levye Lever Kniehebel	Anahtar Allen Key Inbuss-Schlüssel
			L	L1	h	f	b						
AP164	●	PWLNL 1616 H06	100	30	16	20	16	WNGM 0604	TH-617 M6	TA021	TS3	TL3	2,5 Allen
AP165	●	PWLNL 2020 K06	125	30	20	25	20						
AP166	●	PWLNL 2525 M06	150	30	25	32	25						

● Stokta/ In Stock / Lager ○ Sınırlı Stok / Limited Stock / Begrenzte Lagerhaltung

93° PDUNR

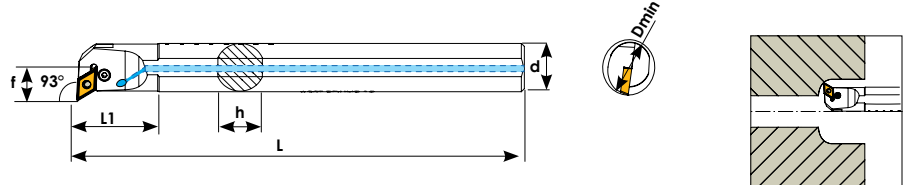

Sipariş Kodu Order Code Best.-Nr.	Stok/Stock/Lager	Ürün Kodu Product Code Produkt-Code	Ölçüler (mm) Dimensions(mm) Abmessungen (mm)						Kullanılan Uç Insert WSP	Sıkma Cıvatası Clamp Screw Klemm-Schraube	Altlık Shim U-Platte	Levye Sacı Lock Pin Rohrstift	Levye Lever Kniehebel	Anahtar Allen Key Inbus-Schlüssel
			Dmin	d	L	L1	f	h						
AP300	●	A25S PDUNR 15	32	25	250	50	17	23	DNMG 1506	TH6134A M6	---	---	TL4A	2,5 Allen
AP302	●	A32T PDUNR 15	40	32	300	55	22	30		TH822 M8	TA014-1	TS-4	TL4B	3 Allen
AP304	●	A40T PDUNR 15	50	40	300	55	27	38						

93° PDUNL

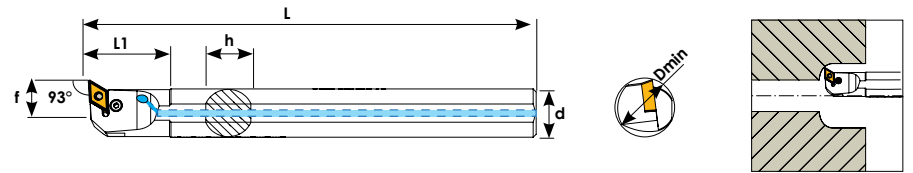
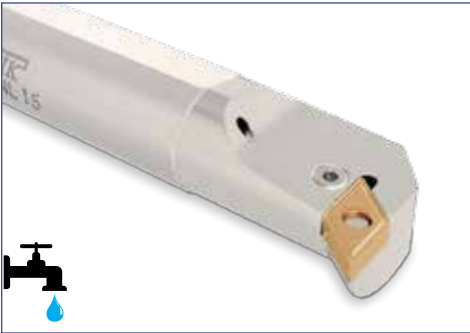

Sipariş Kodu Order Code Best.-Nr.	Stok/Stock/Lager	Ürün Kodu Product Code Produkt-Code	Ölçüler (mm) Dimensions(mm) Abmessungen (mm)						Kullanılan Uç Insert WSP	Sıkma Cıvatası Clamp Screw Klemm-Schraube	Altlık Shim U-Platte	Levye Sacı Lock Pin Rohrstift	Levye Lever Kniehebel	Anahtar Allen Key Inbus-Schlüssel
			Dmin	d	L	L1	f	h						
AP310	●	A25S PDUNL 15	32	25	250	50	17	23	DNMG 1506	TH6134A M6	---	---	TL4A	2,5 Allen
AP312	●	A32T PDUNL 15	40	32	300	55	22	30		TH822 M8	TA014-1	TS-4	TL4B	3 Allen
AP314	●	A40T PDUNL 15	50	40	300	55	27	38						

95° PCLNR

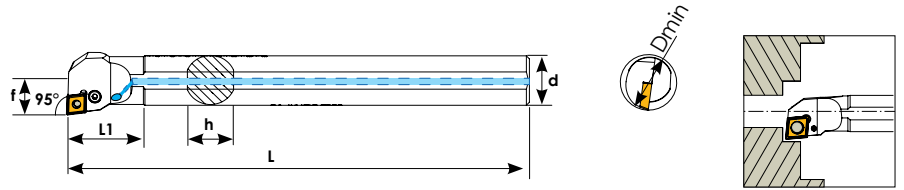

Sipariş Kodu Order Code Best.-Nr.	Stok/Stock/Lager	Ürün Kodu Product Code Produkt-Code	Ölçüler (mm) Dimensions(mm) Abmessungen (mm)						Kullanılan Uç Insert WSP	Sıkma Cıvatası Clamp Screw Klemm-Schraube	Altlık Shim U-Platte	Levyeye Sacı Lock Pin Rohrstift	Levyeye Lever Kniehebel	Anahtar Allen Key Inbuss-Schlüssel
			Dmin	d	L	L1	f	h						
AP340	●	A25S PCLNR 12	32	25	250	50	17	23	CNMG 1204	TH6134A M6	---	---	TL4A	2,5 Allen
AP342	●	A32T PCLNR 12	40	32	300	50	22	30		TH821 M8	TA016-1	TS-4	TL4	3 Allen
AP344	●	A40T PCLNR 12	50	40	300	55	27	38						

95° PCLNL

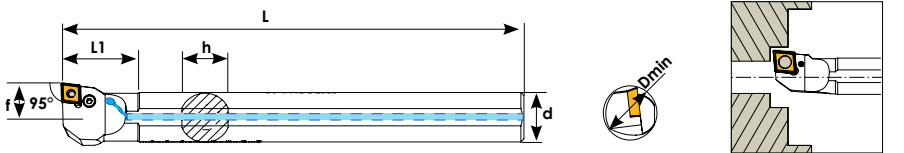

Sipariş Kodu Order Code Best.-Nr.	Stok/Stock/Lager	Ürün Kodu Product Code Produkt-Code	Ölçüler (mm) Dimensions(mm) Abmessungen (mm)						Kullanılan Uç Insert WSP	Sıkma Cıvatası Clamp Screw Klemm-Schraube	Altlık Shim U-Platte	Levyeye Sacı Lock Pin Rohrstift	Levyeye Lever Kniehebel	Anahtar Allen Key Inbuss-Schlüssel
			Dmin	d	L	L1	f	h						
AP350	●	A25S PCLNL 12	32	25	250	50	17	23	CNMG 1204	TH6134A M6	---	---	TL4A	2,5 Allen
AP352	●	A32T PCLNL 12	40	32	300	50	22	30		TH821 M8	TA016-1	TS-4	TL4	3 Allen
AP354	●	A40T PCLNL 12	50	40	300	55	27	38						

95° PWLNR 08

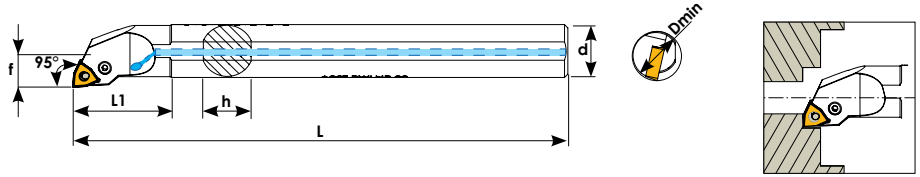

Sipariş Kodu Order Code Best.-Nr.	Stok/Stock/Lager	Ürün Kodu Product Code Produkt-Code	Ölçüler (mm) Dimensions(mm) Abmessungen (mm)					Kullanılan Uç Insert WSP	Sıkma Cıvatası Clamp Screw Klemm-Schraube	Altlık Shim U-Platte	Levye Sacı Lock Pin Rohrstift	Levye Lever Kniehebel	Anahtar Allen Key Inbuss-Schlüssel	
			Dmin	d	L	L1	f							h
AP360	●	A25S PWLNR 08	32	25	250	50	17	23	WNMG 0804	TH6134A M6	---	---	TL4A	2,5 Allen
AP362	●	A32T PWLNR 08	40	32	300	60	22	30		TH821 M8	TA020-1	TS-4	TL4	3 Allen
AP364	●	A40T PWLNR 08	50	40	300	60	27	38						

95° PWLNL 08

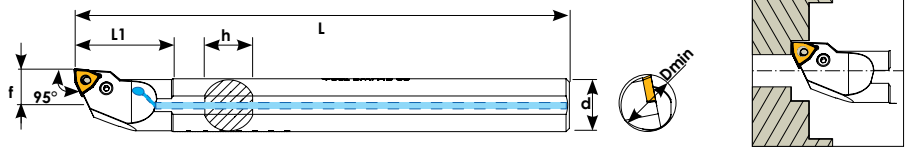
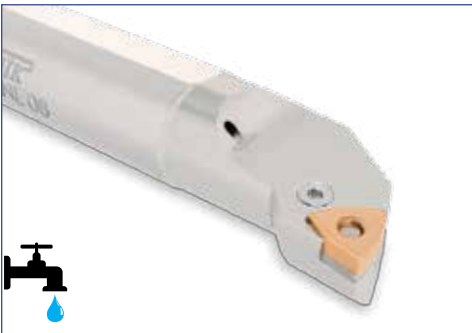

Sipariş Kodu Order Code Best.-Nr.	Stok/Stock/Lager	Ürün Kodu Product Code Produkt-Code	Ölçüler (mm) Dimensions(mm) Abmessungen (mm)					Kullanılan Uç Insert WSP	Sıkma Cıvatası Clamp Screw Klemm-Schraube	Altlık Shim U-Platte	Levye Sacı Lock Pin Rohrstift	Levye Lever Kniehebel	Anahtar Allen Key Inbuss-Schlüssel	
			Dmin	d	L	L1	f							h
AP370	●	A25S PWLNL 08	32	25	250	50	17	23	WNMG 0804	TH6134A M6	---	---	TL4A	2,5 Allen
AP372	●	A32T PWLNL 08	40	32	300	60	22	30		TH821 M8	TA020-1	TS-4	TL4	3 Allen
AP374	●	A40T PWLNL 08	50	40	300	60	27	38						

95° PWLNR 06

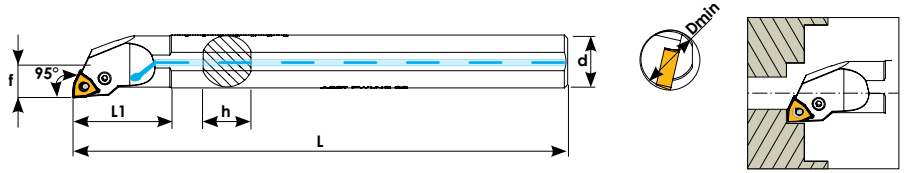
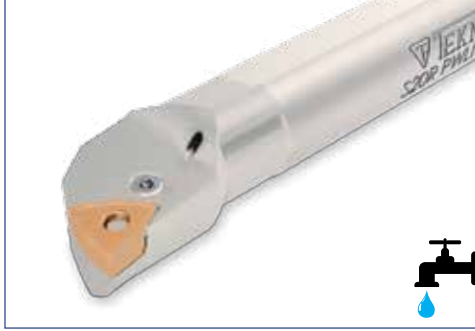

Sipariş Kodu Order Code Best.-Nr.	Stok/Stock/Lager	Ürün Kodu Product Code Produkt-Code	Ölçüler (mm) Dimensions(mm) Abmessungen (mm)						Kullanılan Uç Insert WSP	Sıkma Civatası Clamp Screw Klemm- Schraube	Altlık Shim U-Platte	Levye Sacı Lock Pin Rohrstift	Levye Lever Kniehebel	Anahtar Allen Key Inbuss-Schlüssel
			Dmin	d	L	L1	f	h						
AP380	●	A16R PWLNR 06	20	16	200	40	11	15	WNGM 0604	TH512 M5	TA021	TS3	TL3B	2 Allen
AP382	●	A20R PWLNR 06	25	20	200	40	13	18						

95° PWLNL 06

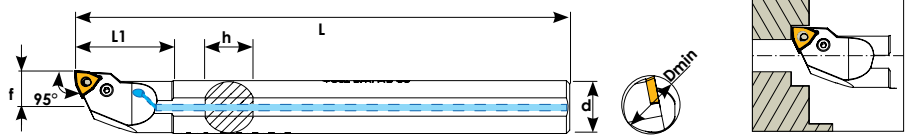

Sipariş Kodu Order Code Best.-Nr.	Stok/Stock/Lager	Ürün Kodu Product Code Produkt-Code	Ölçüler (mm) Dimensions(mm) Abmessungen (mm)						Kullanılan Uç Insert WSP	Sıkma Civatası Clamp Screw Klemm- Schraube	Altlık Shim U-Platte	Levye Sacı Lock Pin Rohrstift	Levye Lever Kniehebel	Anahtar Allen Key Inbuss-Schlüssel
			Dmin	d	L	L1	f	h						
AP388	●	A16R PWLNL 06	20	16	200	40	11	15	WNGM 0604	TH512 M5	TA021	TS3	TL3B	2 Allen
AP390	●	A20R PWLNL 06	25	20	200	40	13	18						



D-M-C Sistem Kater
D-M-C System

93° DDJNR

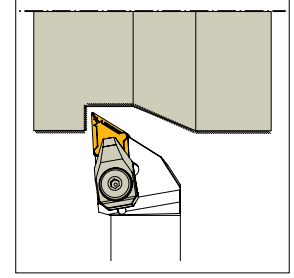
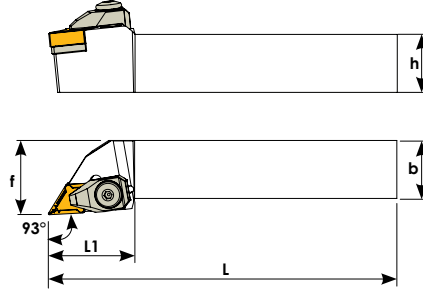

Sipariş Kodu Order Code Best.-Nr.	Stok/Stock/Lager	Ürün Kodu Product Code Produkt-Code	Ölçüler (mm) Dimensions (mm) Abmessungen (mm)					Kullanılan Uç Insert WSP	Baskı Civatası Locking Screw Verriegelungs Schraube	Altlık Shim U-Platte	Altlık Civatası Shim Screw U-Platte Schraube	Baskı Kepi Clamp Spann pratze	Yay Spring Feder	Pul Washer U-Scheibe	Anahtar Allen Key Inbuss- Schlüssel
			L	L1	h	f	b								
D167	●	DDJNR 2020 K11	125	30	20	25	20	DN-- 1104	TC046 M5	TA030	TC075 M4x11	BK024	BY041	BSP031	3 Allen
D168	●	DDJNR 2525 M11	150	30	25	32	25								
D170	●	DDJNR 2020 K15	125	35	20	25	20	DN-- 1506	TC044 M6	TA014-1	TC038 M4x10	BK020	BY040	BSP030	5 Allen
D172	●	DDJNR 2525 M15	150	35	25	32	25								
D174	●	DDJNR 3232 P15	170	35	32	40	32								

93° DDJNL

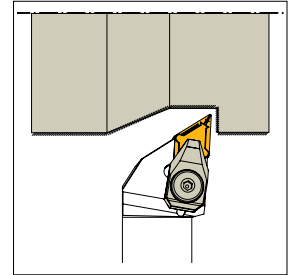
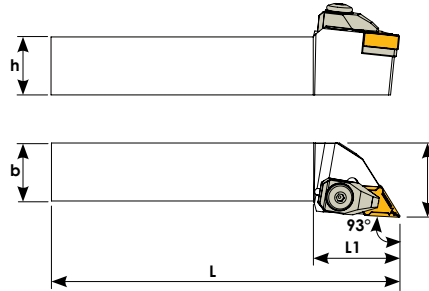

Sipariş Kodu Order Code Best.-Nr.	Stok/Stock/Lager	Ürün Kodu Product Code Produkt-Code	Ölçüler (mm) Dimensions (mm) Abmessungen (mm)					Kullanılan Uç Insert WSP	Baskı Civatası Locking Screw Verriegelungs Schraube	Altlık Shim U-Platte	Altlık Civatası Shim Screw U-Platte Schraube	Baskı Kepi Clamp Spann pratze	Yay Spring Feder	Pul Washer U-Scheibe	Anahtar Allen Key Inbuss- Schlüssel
			L	L1	h	f	b								
D307-1	●	DDJNL 2020 K11	125	30	20	25	20	DN-- 1104	TC046 M5	TA030	TC075 M4x11	BK024	BY041	BSP031	3 Allen
D308	●	DDJNL 2525 M11	150	30	25	32	25								
D310	●	DDJNL 2020 K15	125	35	20	25	20	DN-- 1506	TC044 M6	TA014-1	TC038 M4x10	BK020	BY040	BSP030	5 Allen
D312	●	DDJNL 2525 M15	150	35	25	32	25								
D314	●	DDJNL 3232 P15	170	35	32	40	32								

62,5° DDNNN

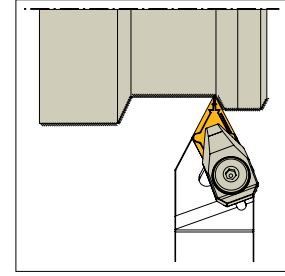
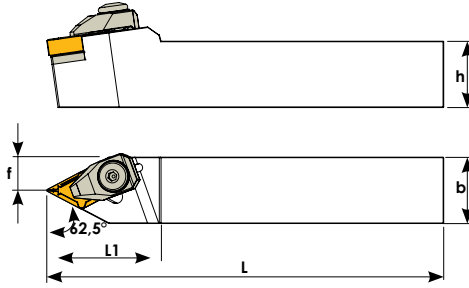

Sipariş Kodu Order Code Best.-Nr.	Stok/Stock/Lager	Ürün Kodu Product Code Produkt-Code	Ölçüler (mm) Dimensions (mm) Abmessungen (mm)					Kullanılan Uç Insert WSP	Baskı Civatası Locking Screw Verriegelungs-Schraube	Altlık Shim U-Platte	Altlık Civatası Shim Screw U-Platte Schraube	Baskı Kepi Clamp Spannpratze	Yay Spring Feder	Pul Washer U-Scheibe	Anahtar Allen Key Inbuss-Schlüssel
			L	L1	h	f	b								
D104	●	DDNNN 2020 K15	125	40	20	10	20	DN-- 1506	TC044 M6	TA014- 1	TC038 M4x10	BK020	BY040	BSP030	4 Allen
D106	●	DDNNN 2525 M15	150	40	25	12,5	25								
D109	●	DDNNN 3232 P15	170	40	32	16	32								



107,5° DDHNR

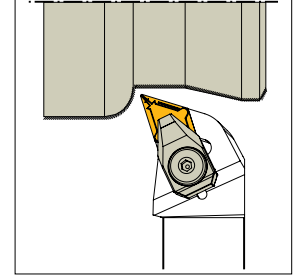
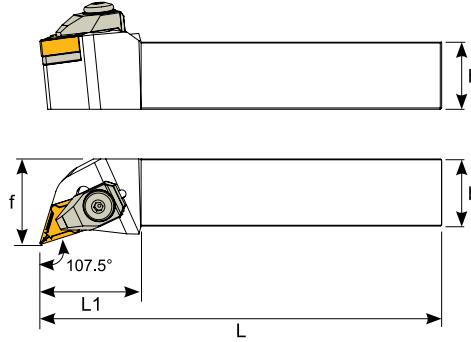

Sipariş Kodu Order Code Best.-Nr.	Stok/Stock/Lager	Ürün Kodu Product Code Produkt-Code	Ölçüler (mm) Dimensions (mm) Abmessungen (mm)					Kullanılan Uç Insert WSP	Baskı Cıvatası Locking Screw Verriegelungs Schraube	Altılık Shim U-Platte	Altılık Cıvatası Shim Screw U-Platte Schraube	Baskı Kepi Clamp Spann pratze	Yay Spring Feder	Pul Washer U-Scheibe	Anahtar Allen Key Inbuss- Schlüssel
			L	L1	h	f	b								
D096	●	DDHNR 2020 K15	125	33	20	25	20	DN-- 1506	TC044 M6	TA014-1	TC038 M4x10	BK020	BY040	BSP030	4 Allen
D097	●	DDHNR 2525 M15	150	33	25	32	25								
D098	●	DDHNR 3232 P15	170	33	32	40	32								

107,5° DDHNL

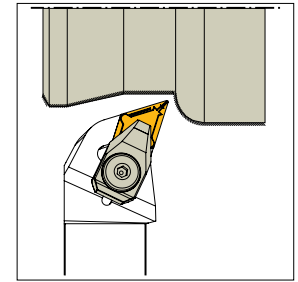
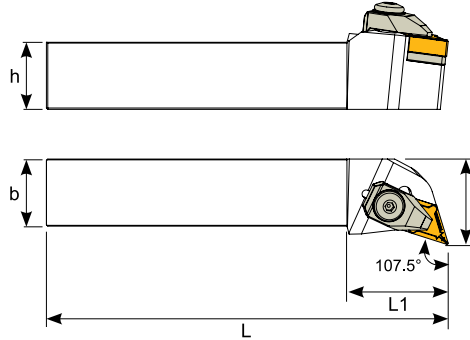

Sipariş Kodu Order Code Best.-Nr.	Stok/Stock/Lager	Ürün Kodu Product Code Produkt-Code	Ölçüler (mm) Dimensions (mm) Abmessungen (mm)					Kullanılan Uç Insert WSP	Baskı Cıvatası Locking Screw Verriegelungs Schraube	Altılık Shim U-Platte	Altılık Cıvatası Shim Screw U-Platte Schraube	Baskı Kepi Clamp Spann pratze	Yay Spring Feder	Pul Washer U-Scheibe	Anahtar Allen Key Inbuss- Schlüssel
			L	L1	h	f	b								
D295	●	DDHNL 2020 K15	125	33	20	25	20	DN-- 1506	TC044 M6	TA014-1	TC038 M4x10	BK020	BY040	BSP030	4 Allen
D296	●	DDHNL 2525 M15	150	33	25	32	25								
D297	●	DDHNL 3232 P15	170	33	32	40	32								

D Sistem Dış Çap Kater
D System External Turning Holders
D System Klemmhalter

Technical solution for quality

Kalite için TEKNİK Çözüm

93° DDJNR

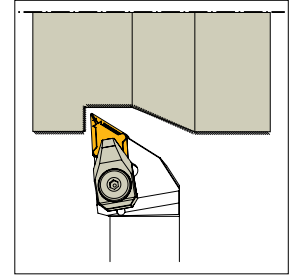
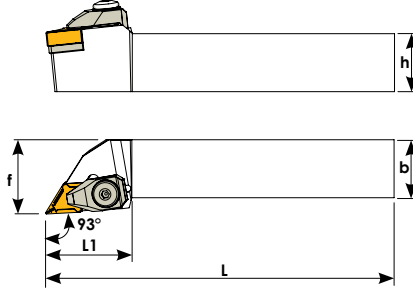

Sipariş Kodu Order Code Best.-Nr.	Stok/Stock/Lager	Ürün Kodu Product Code Produkt-Code	Ölçüler (mm) Dimensions(mm) Abmessungen (mm)					Kullanılan Uç Insert WSP	Baskı Civatası Locking Screw Verriegelungs Schraube	Aflık Shim U-Platte	Aflık Civatası Shim Screw U-Platte Schraube	Baskı Kepi Clamp Spann pratze	Yay Spring Feder	Pul Washer U-Scheibe	Anahtar Allen Key Inbuss- Schlüssel
			L	L1	h	f	b								
D171	●	DDJNR 2020 K15	125	38	20	25	20								
D169	●	DDJNR 2525 M15	150	38	25	32	25	DN--1504	TC044 M6	TA014- 1	TC038 M4x10	BK020	BY040	BSP030	4 Allen

93° DDJNL

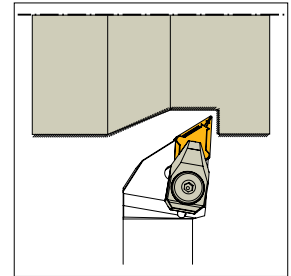
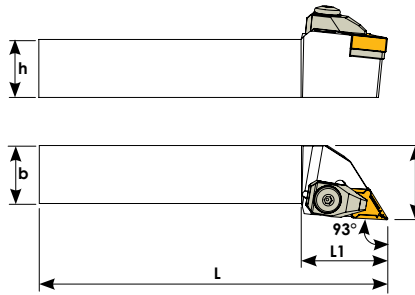

Sipariş Kodu Order Code Best.-Nr.	Stok/Stock/Lager	Ürün Kodu Product Code Produkt-Code	Ölçüler (mm) Dimensions(mm) Abmessungen (mm)					Kullanılan Uç Insert WSP	Baskı Civatası Locking Screw Verriegelungs Schraube	Aflık Shim U-Platte	Aflık Civatası Shim Screw U-Platte Schraube	Baskı Kepi Clamp Spann pratze	Yay Spring Feder	Pul Washer U-Scheibe	Anahtar Allen Key Inbuss- Schlüssel
			L	L1	h	f	b								
D313	●	DDJNL 2020 K15	125	38	20	25	20								
D309	●	DDJNL 2525 M15	150	38	25	32	25	DN-- 1504	TC044 M6	TA014- 1	TC038 M4x10	BK020	BY040	BSP030	4 Allen

95° DWLNR

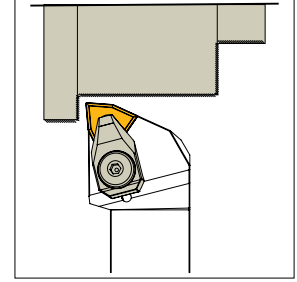
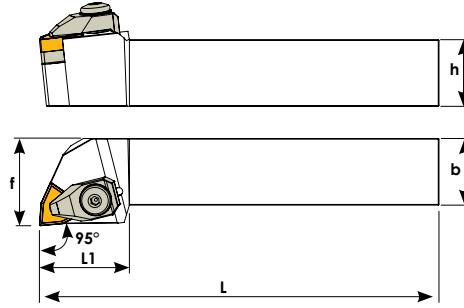
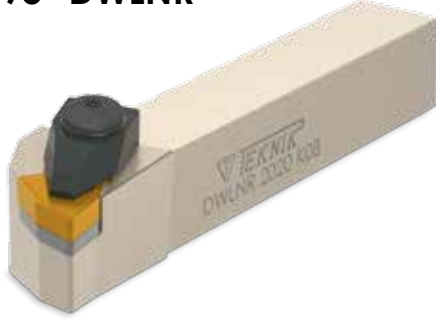

Sipariş Kodu Order Code Best.-Nr.	Stok/Stock/Lager	Ürün Kodu Product Code Produkt-Code	Ölçüler (mm) Dimensions(mm) Abmessungen (mm)					Kullanılan Uç Insert WSP	Baskı Civatası Locking Screw Verriegelungs Schraube	Altlık Shim U-Platte	Altlık Civatası Shim Screw U-Platte Schraube	Baskı Kepi Clamp Spann- pratze	Yay Spring Feder	Pul Washer U- Scheibe	Anahtar Allen Key Inbuss- Schlüssel
			L	L1	h	f	b								
D181	●	DWLNR 1616 H06	100	26	16	20	16	WN-- 0604	TC046 M5	TA021	TC034 M3x7	BK024	BY041	BSP031	3 Allen
D177	●	DWLNR 2020 K06	125	26	20	25	20								
D179	●	DWLNR 2525 M06	150	26	25	32	25								
D176	●	DWLNR 2020 K08	125	32	20	25	20	WN-- 0804	TC044 M6	TA020-1	TC083 M5x12	BK020	BY040	BSP030	4 Allen
D178	●	DWLNR 2525 M08	150	32	25	32	25								
D180	●	DWLNR 3232 P08	170	32	32	40	32								

95° DWLNL

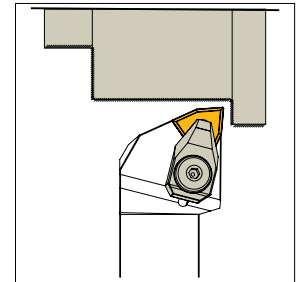
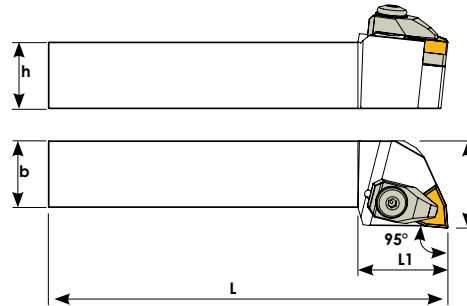
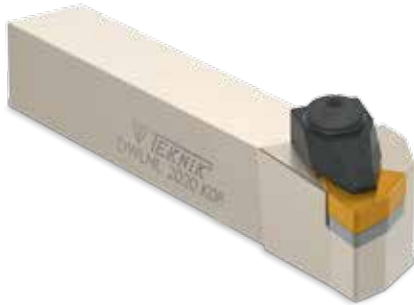

Sipariş Kodu Order Code Best.-Nr.	Stok/Stock/Lager	Ürün Kodu Product Code Produkt-Code	Ölçüler (mm) Dimensions(mm) Abmessungen (mm)					Kullanılan Uç Insert WSP	Baskı Civatası Locking Screw Verriegelungs Schraube	Altlık Shim U-Platte	Altlık Civatası Shim Screw U-Platte Schraube	Baskı Kepi Clamp Spann- pratze	Yay Spring Feder	Pul Washer U- Scheibe	Anahtar Allen Key Inbuss- Schlüssel
			L	L1	h	f	b								
D328	●	DWLNL 1616 H06	100	26	16	20	16	WN-- 0604	TC046 M5	TA021	TC034 M3x7	BK024	BY041	BSP031	3 Allen
D329	●	DWLNL 2020 K06	125	26	20	25	20								
D319	●	DWLNL 2525 M06	150	26	25	32	25								
D316	●	DWLNL 2020 K08	125	32	20	25	20	WN-- 0804	TC044 M6	TA020-1	TC083 M5x12	BK020	BY040	BSP030	4 Allen
D318	●	DWLNL 2525 M08	150	32	25	32	25								
D320	●	DWLNL 3232 P08	170	32	32	40	32								

95° MWLNR

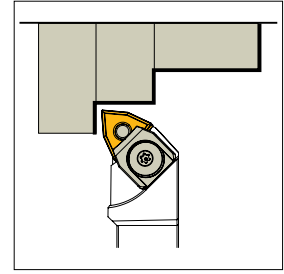
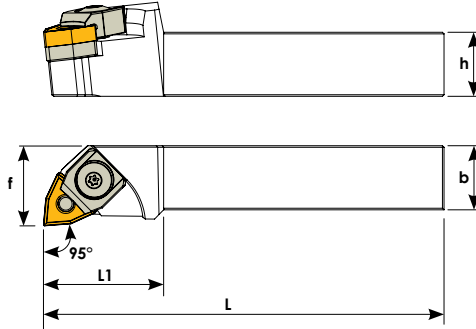

Sipariş Kodu Order Code Best.-Nr.	Stok/Stock/Lager	Ürün Kodu Product Code Produkt-Code	Ölçüler (mm) Dimensions (mm) Abmessungen (mm)					Kullanılan Uç Insert WSP	Baskı Civatası Locking Screw Verriegelungs Schraube	Altlık Shim U-Platte	Altlık Pimi Lock Pin Rohrstift	Baskı Kepi Clamp Spann pratze	Yay Spring Feder	Pul Washer U-Scheibe	Anahtar Allen Key Inbuss- Schlüssel
			L	L1	h	f	b								
D182	●	MWLNR 2020 K08	125	35	20	25	20	WN --0804	TC044 M6	TA020	BSP021	BK026	BY040	BSP030	4 Allen
D184	●	MWLNR 2525 M08	150	35	25	32	25								
D185	●	MWLNR 3232 P08	170	35	32	40	32								

95° MWLNL

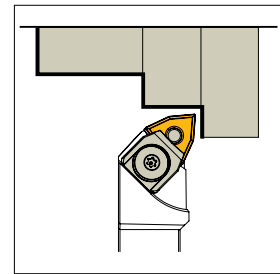
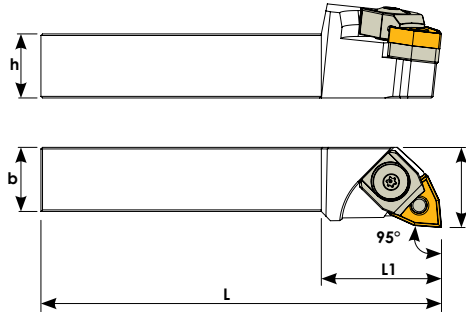

Sipariş Kodu Order Code Best.-Nr.	Stok/Stock/Lager	Ürün Kodu Product Code Produkt-Code	Ölçüler (mm) Dimensions (mm) Abmessungen (mm)					Kullanılan Uç Insert WSP	Baskı Civatası Locking Screw Verriegelungs Schraube	Altlık Shim U-Platte	Altlık Pimi Lock Pin Rohrstift	Baskı Kepi Clamp Spann pratze	Yay Spring Feder	Pul Washer U-Scheibe	Anahtar Allen Key Inbuss- Schlüssel
			L	L1	h	f	b								
D322	●	MWLNL 2020 K08	125	35	20	25	20	WN --0804	TC044 M6	TA020	BSP021	BK026	BY040	BSP030	4 Allen
D324	●	MWLNL 2525 M08	150	35	25	32	25								
D326	●	MWLNL 3232 P08	170	35	32	40	32								

95° MWMNN

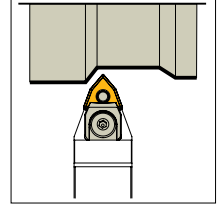
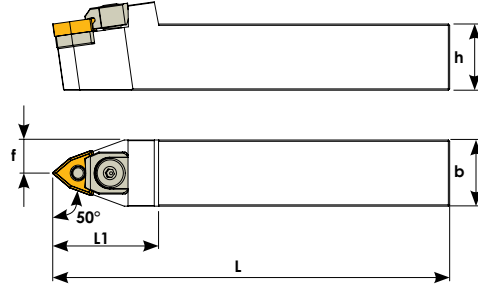

Sipariş Kodu Order Code Best.-Nr.	Stok/Stock/Lager	Ürün Kodu Product Code Produkt-Code	Ölçüler (mm) Dimensions (mm) Abmessungen (mm)					Kullanılan Uç Insert WSP	Baskı Cıvatası Locking Screw Verriegelungs Schraube	Altlık Shim U-Platte	Altlık Pimi Lock Pin Rohrstift	Baskı Kepi Clamp Spann pratze	Yay Spring Feder	Pul Washer U-Scheibe	Anahtar Allen Key Inbuss- Schlüssel
			L	L1	h	f	b								
D114	●	MWMNN 2020 K08	125	40	20	10	20	WN --0804	TC044 M6	TA020	BSP021	BK026	BY040	BSP030	4 Allen
D116	●	MWMNN 2525 M08	150	40	25	12.5	25								

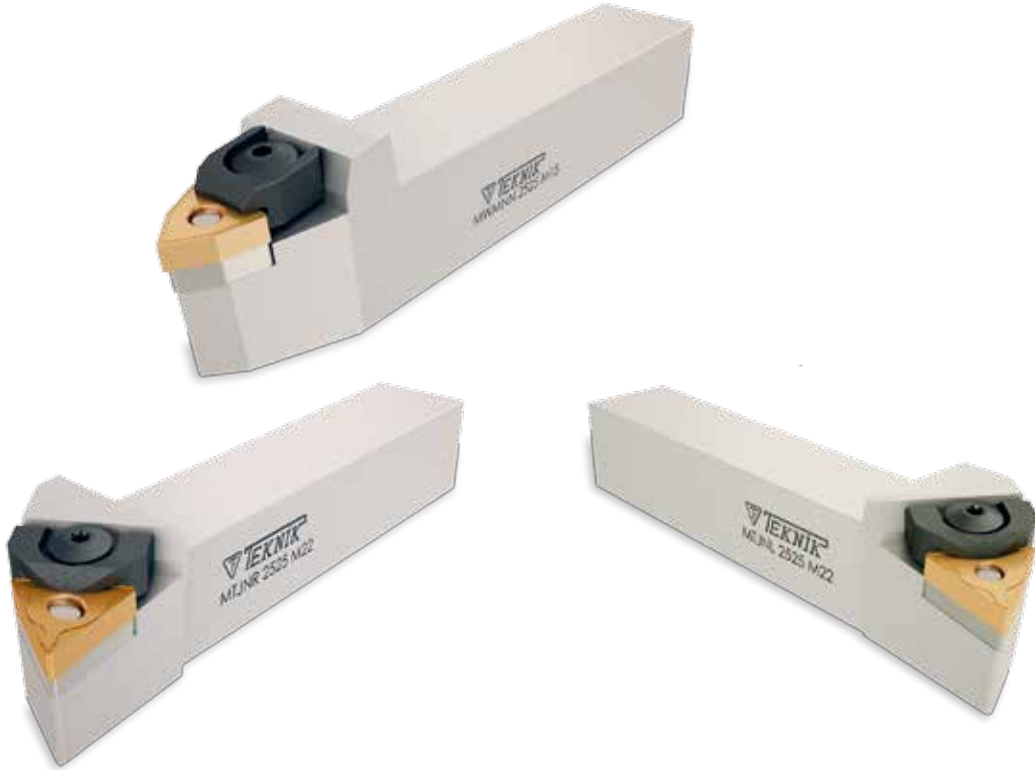

93° MTJNR

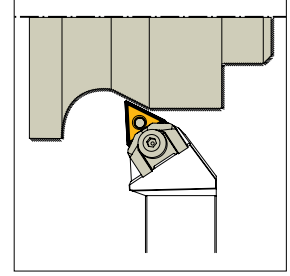
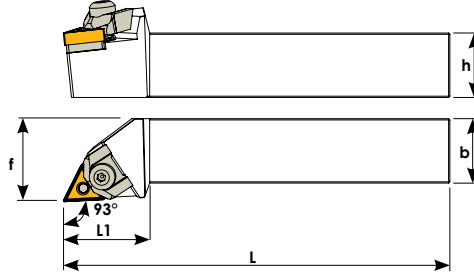

Sipariş Kodu Order Code Best.-Nr.	Stok/Stock/Lager	Ürün Kodu Product Code Produkt-Code	Ölçüler (mm) Dimensions (mm) Abmessungen (mm)						Kullanılan Uç Insert WSP	Baskı Civatası Locking Screw Verriegelungs Schraube	Altlık Shim U-Platte	Altlık Pimi Lock Pin Rohrstift	Baskı Kepi Clamp Spann pratze	Yay Spring Feder	Pul Washer U-Scheibe	Anahtar Allen Key Inbuss- Schlüssel
			L	L1	h	f	b									
D194	●	MTJNR 2020 K16	125	35	20	25	20	TN --1604	TC046 M5	TA019	BSP020	BK022	BY043	BSP031	3 Allen	
D196	●	MTJNR 2525 M16	150	35	25	32	25									
D198	●	MTJNR 3232 P16	170	35	32	40	32									
D200	●	MTJNR 2020 K22	125	40	20	25	20	TN --2204	TC044 M6	TA045	BSP021	BK023	BY040	BSP030	4 Allen	
D202	●	MTJNR 2525 M22	150	40	25	32	25									
D204	●	MTJNR 3232 P22	170	40	32	40	32									

93° MTJNL

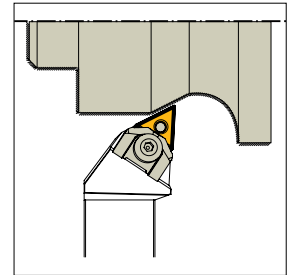
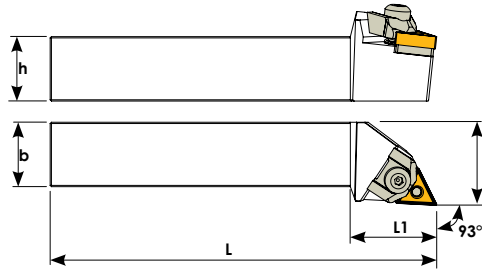

Sipariş Kodu Order Code Best.-Nr.	Stok/Stock/Lager	Ürün Kodu Product Code Produkt-Code	Ölçüler (mm) Dimensions (mm) Abmessungen (mm)						Kullanılan Uç Insert WSP	Baskı Civatası Locking Screw Verriegelungs Schraube	Altlık Shim U-Platte	Altlık Pimi Lock Pin Rohrstift	Baskı Kepi Clamp Spann pratze	Yay Spring Feder	Pul Washer U-Scheibe	Anahtar Allen Key Inbuss- Schlüssel
			L	L1	h	f	b									
D332	●	MTJNL 2020 K16	125	35	20	25	20	TN --1604	TC046 M5	TA019	BSP020	BK022	BY043	BSP031	3 Allen	
D334	●	MTJNL 2525 M16	150	35	25	32	25									
D336	●	MTJNL 3232 P16	170	35	32	40	32									
D338	●	MTJNL 2020 K22	125	40	20	25	20	TN --2204	TC044 M6	TA045	BSP021	BK023	BY040	BSP030	4 Allen	
D340	●	MTJNL 2525 M22	150	40	25	32	25									
D342	●	MTJNL 3232 P22	170	40	32	40	32									

60° MTENN

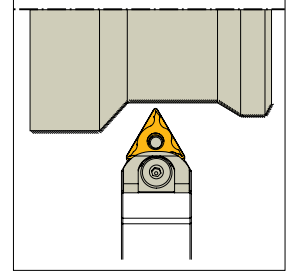
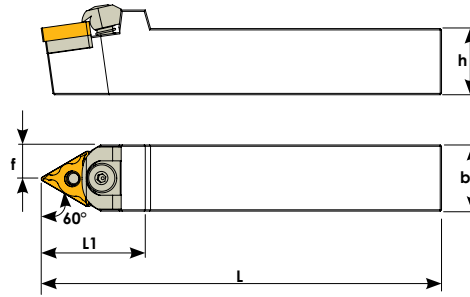

Sipariş Kodu Order Code Best.-Nr.	Stok/Stock/Lager	Ürün Kodu Product Code Produkt-Code	Ölçüler (mm) Dimensions (mm) Abmessungen (mm)					Kullanılan Uç Insert WSP	Baskı Civatası Locking Screw Verriegelungs Schraube	Altık Shim U-Platte	Altık Pimi Lock Pin Rohrstift	Baskı Kepi Clamp Spann- pratze	Yay Spring Feder	Pul Washer U-Scheibe	Anahtar Allen Key Inbuss- Schlüssel
			L	L1	h	f	b								
D108	●	MTENN 2020 K16	125	35	20	10	20	TN-- 1604	TC046 M5	TA019	BSP020	BK022	BY043	BSP031	3 Allen
D110	●	MTENN 2525 M16	150	35	25	12.5	25								
D112	●	MTENN 2525 M22	150	40	25	12.5	25								
D113	●	MTENN 3232 P22	170	40	32	16	32								



93° DVJNR

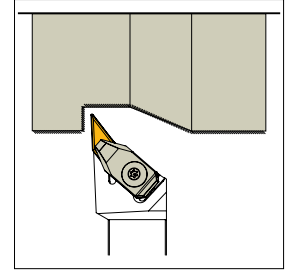
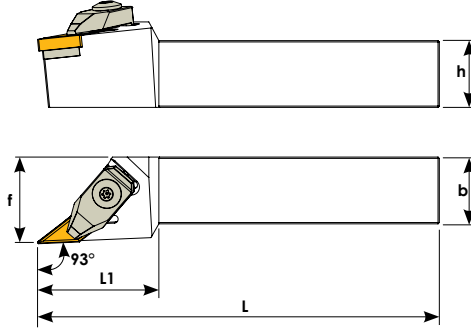

Sipariş Kodu Order Code Best.-Nr.	Stok/Stock/Lager	Ürün Kodu Product Code Produkt-Code	Ölçüler (mm) Dimensions(mm) Abmessungen (mm)					Kullanılan Uç Insert WSP	Baskı Civatası Locking Screw Verriegelungs Schraube	Altık Shim U-Platte	Altık Civatası Shim Screw U-Platte Schraube	Baskı Kepi Clamp Spann pratze	Yay Spring Feder	Pul Washer U-Scheibe	Anahtar Allen Key Inbus- Schlüssel
			L	L1	h	f	b								
D105-1	●	DVJNR 2020 K16	125	40	20	27	20	VN-- 1604	TC046 M5	TA033	TC075 M4x11-50	BK021	BY043	BSP031	3 Allen
D105	●	DVJNR 2525 M16	150	40	25	32	25								



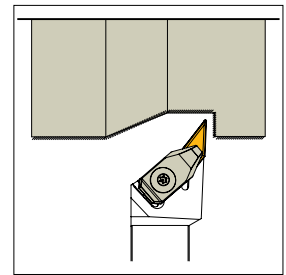
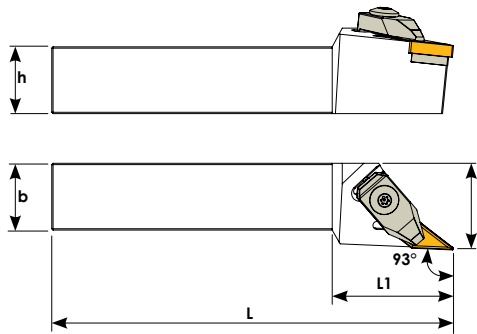



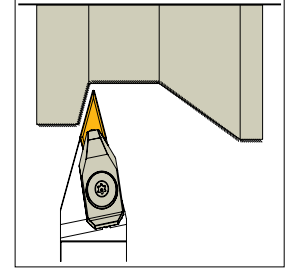
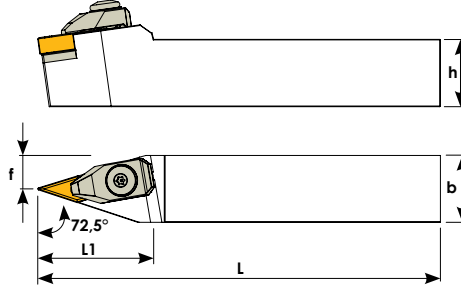

93° DVJNL



Sipariş Kodu Order Code Best.-Nr.	Stok/Stock/Lager	Ürün Kodu Product Code Produkt-Code	Ölçüler (mm) Dimensions(mm) Abmessungen (mm)					Kullanılan Uç Insert WSP	Baskı Civatası Locking Screw Verriegelungs Schraube	Altık Shim U-Platte	Altık Civatası Shim Screw U-Platte Schraube	Baskı Kepi Clamp Spann pratze	Yay Spring Feder	Pul Washer U-Scheibe	Anahtar Allen Key Inbus- Schlüssel
			L	L1	h	f	b								
D343	●	DVJNL 2020 K16	125	40	20	27	20	VN-- 1604	TC046 M5	TA033	TC075 M4x11-50	BK021	BY043	BSP031	3 Allen
D344	●	DVJNL 2525 M16	150	40	25	32	25								







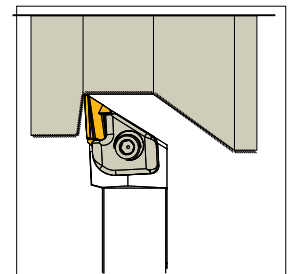
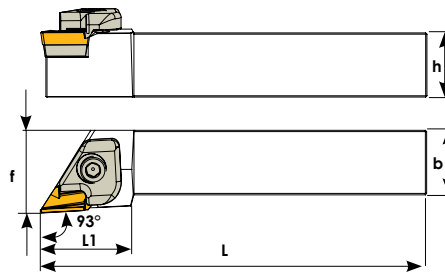

72,5° DVVNN



Sipariş Kodu Order Code Best.-Nr.	Stok/Stock/Lager	Ürün Kodu Product Code Produkt-Code	Ölçüler (mm) Dimensions (mm) Abmessungen (mm)					Kullanılan Uç Insert WSP	Baskı Civatası Locking Screw Verriegelungs Schraube	Altılık Shim U-Platte	Altılık Civatası Shim Screw U-Platte Schraube	Baskı Kepi Clamp Spann pratze	Yay Spring Feder	Pul Washer U-Scheibe	Anahtar Allen Key Inbuss- Schlüssel
			L	L1	h	f	b								
D105-2	●	DVVNN 2525 M16	150	45	25	12,5	25								
								VN-- 1604	TC046 M5	TA033	TC075 M4x11-50	BK021	BY043	BSP031	3 Allen

93° CKJNR



Sipariş Kodu Order Code Best.-Nr.	Stok/Stock/Lager	Ürün Kodu Product Code Produkt-Code	Ölçüler (mm) Dimensions (mm) Abmessungen (mm)					Kullanılan Uç Insert WSP	Baskı Civatası Locking Screw Verriegelungs Schraube	Altılık Shim U-Platte	Altılık Civatası Shim Screw U-Platte Schraube	Baskı Kepi Clamp Spann pratze	Yay Spring Feder	Pul Washer U-Scheibe	Anahtar Allen Key Inbuss- Schlüssel
			L	L1	h	f	b								
RD018	●	CKJNR 2020 K16	125	32	20	27	20								
RD014	●	CKJNR 2525 M16	150	35	25	30	25	KNUX 1604	TC044 M6	TA046	TC036 M3x10	BK028	BY042	BSP030	4 Allen
RD013	●	CKJNR 3232 P16	170	35	32	40	32								

95° DCLNR

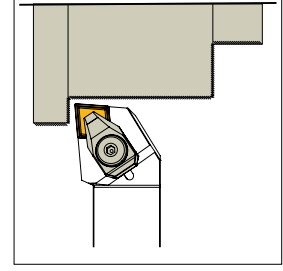
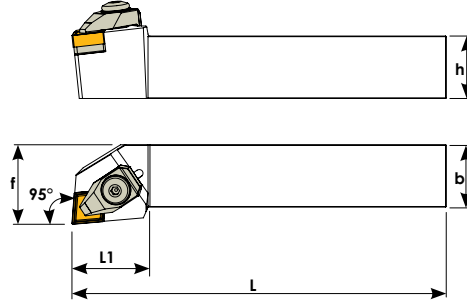

Sipariş Kodu Order Code Best.-Nr.	Stok/Stock/Lager	Ürün Kodu Product Code Produkt-Code	Ölçüler (mm) Dimensions (mm) Abmessungen (mm)					Kullanılan Uç Insert WSP	Altlık Shim U-Platte	Altlık Cıvatası Shim Screw U-Platte Schraube	Baskı Keçi Clamp Spann pratze	Baskı Cıvatası Locking Screw Verriegelungs Schraube	Yay Spring Feder	Pul Washer U-Scheibe	Anahtar Allen Key Inbuss-Schlüssel
			L	L1	h	f	b								
D160	●	DCLNR 2020 K12	125	30	20	25	20	CN-- 1204	TA016-1	TC038 M4x10	BK020	TC044 M6	BY040	BSP030	4 Allen
D162	●	DCLNR 2525 M12	150	30	25	32	25								
D164	●	DCLNR 3232 P12	170	30	32	40	32	CN-- 1606	TA022	TC095 M5x11,8	BK018	TC047 M8	BY044	BSP032	
D162-1	●	DCLNR 2525 M16	150	36	25	32	25								
D165	●	DCLNR 3232 P16	170	36	32	40	32	CN-- 1906	TA017	TC039 M6x12	BK025	TC047 M8	BY044	BSP032	
D163	●	DCLNR 2525 M19	150	40	25	32	25								
D166	●	DCLNR 3232 P19	170	40	32	40	32	CN-- 1906	TA017	TC039 M6x12	BK025	TC047 M8	BY044	BSP032	
D166-1	●	DCLNR 4040 S19	250	40	40	40	40								

95° DCLNL

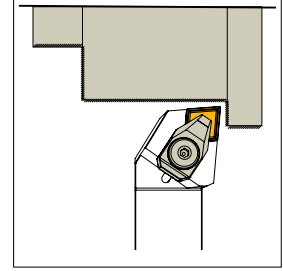
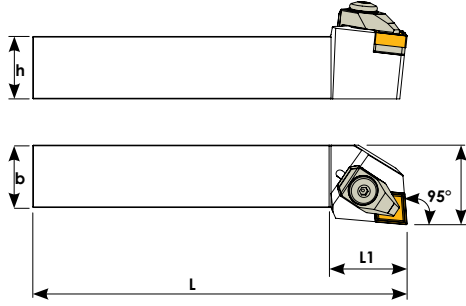

Sipariş Kodu Order Code Best.-Nr.	Stok/Stock/Lager	Ürün Kodu Product Code Produkt-Code	Ölçüler (mm) Dimensions (mm) Abmessungen (mm)					Kullanılan Uç Insert WSP	Altlık Shim U-Platte	Altlık Cıvatası Shim Screw U-Platte Schraube	Baskı Keçi Clamp Spann pratze	Baskı Cıvatası Locking Screw Verriegelungs Schraube	Yay Spring Feder	Pul Washer U-Scheibe	Anahtar Allen Key Inbuss-Schlüssel
			L	L1	h	f	b								
D301	●	DCLNL 2020 K12	125	30	20	25	20	CN-- 1204	TA016-1	TC038 M4x10	BK020	TC044 M6	BY040	BSP030	4 Allen
D302	●	DCLNL 2525 M12	150	30	25	32	25								
D305	●	DCLNL 3232 P12	170	30	32	40	32	CN-- 1606	TA022	TC095 M5x11,8	BK018	TC047 M8	BY044	BSP032	
D303	●	DCLNL 2525 M16	150	36	25	32	25								
D306	●	DCLNL 3232 P16	170	36	32	40	32	CN-- 1906	TA017	TC039 M6x12	BK025	TC047 M8	BY044	BSP032	
D304	●	DCLNL 2525 M19	150	40	25	32	25								
D307	●	DCLNL 3232 P19	170	40	32	40	32	CN-- 1906	TA017	TC039 M6x12	BK025	TC047 M8	BY044	BSP032	
D307-2	●	DCLNL 4040 S19	250	40	40	40	40								

50° DCMNN

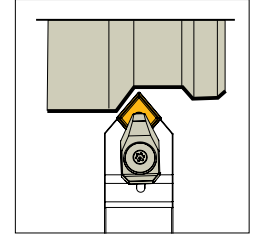
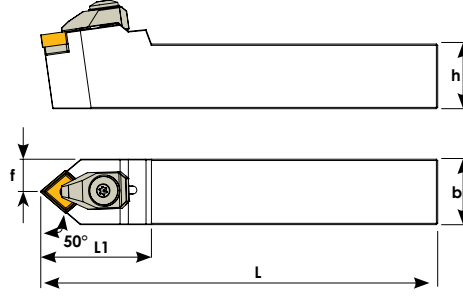

Sipariş Kodu Order Code Best.-Nr.	Stok/Stock/Lager	Ürün Kodu Product Code Produkt-Code	Ölçüler (mm) Dimensions(mm) Abmessungen (mm)					Kullanılan Uç Insert WSP	Baskı Cıvatası Locking Screw Verriegelungs Schraube	Altılık Shim U-Platte	Altılık Cıvatası Shim Screw U-Platte Schraube	Baskı Kepi Clamp Spannpratze	Yay Spring Feder	Pul Washer U-Scheibe	Anahtar Allen Key Inbuss-Schlüssel
			L	L1	h	f	b								
D214-1	●	DCMNN 2020 K12	125	35	20	10	20	CN-- 1204	TC044 M6	TA016	TC038 M4x10	BK020	BY040	BSP030	4 Allen
D215	●	DCMNN 2525 M12	150	42	25	12,5	25								

45° DCSNR

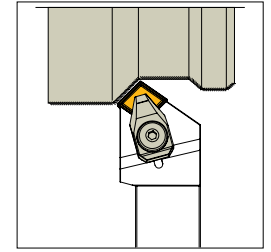
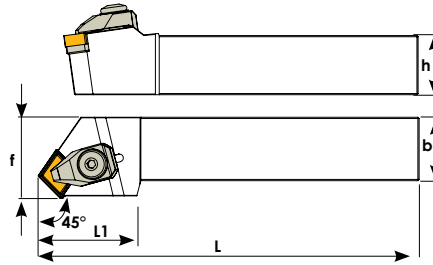

D218	●	DCSNR 2525 M12	150	35	25	32	25	CN-- 1204	TC044 M6	TA016	TC038 M4x10	BK020	BY040	BSP030	4 Allen

40° DCXNN

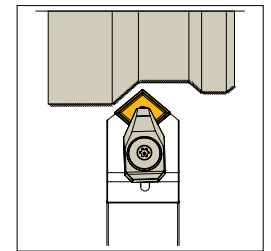
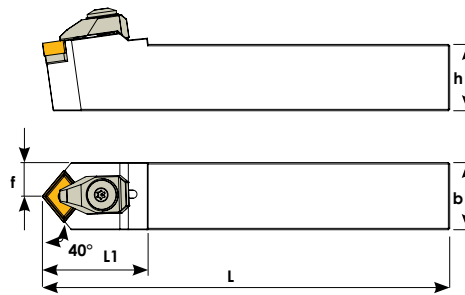

Sipariş Kodu Order Code Best.-Nr.	Stok/Stock/Lager	Ürün Kodu Product Code Produkt-Code	Ölçüler (mm) Dimensions(mm) Abmessungen (mm)					Kullanılan Uç Insert WSP	Baskı Cıvatası Locking Screw Verriegelungs Schraube	Altılık Shim U-Platte	Altılık Cıvatası Shim Screw U-Platte Schraube	Baskı Kepi Clamp Spannpratze	Yay Spring Feder	Pul Washer U-Scheibe	Anahtar Allen Key Inbuss-Schlüssel
			L	L1	h	f	b								
D216	●	DCXNN 2525 M12	150	35	25	12,5	25	CN-- 1204	TC044 M6	TA016	TC038 M4x10	BK020	BY040	BSP030	4 Allen

45° DSSNR

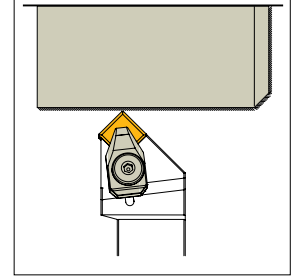
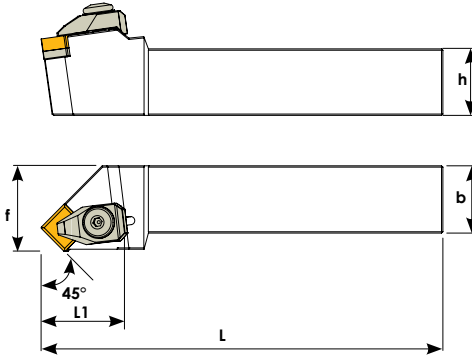

Sipariş Kodu Order Code Best.-Nr.	Stok/Stock/Lager	Ürün Kodu Product Code Produkt-Code	Ölçüler (mm) Dimensions (mm) Abmessungen (mm)					Kullanılan Uç Insert WSP	Baskı Cıvatası Locking Screw Verriegelungs Schraube	Altılık Shim U-Platte	Altılık Cıvatası Shim Screw U-Platte Schraube	Baskı Kepli Clamp Spann pratze	Yay Spring Feder	Pul Washer U-Scheibe	Anahtar Allen Key Inbuss-Schlüssel
			L	L1	h	f	b								
D210	●	DSSNR 2020 K12	125	35	20	25	20	SNMG 1204	TC044 M6	TA050	TC038 M4x10	BK020	BY040	BSP030	4 Allen
D212	●	DSSNR 2525 M12	150	35	25	32	25								

75° DCKNR

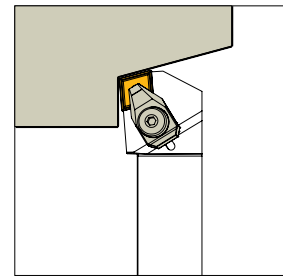
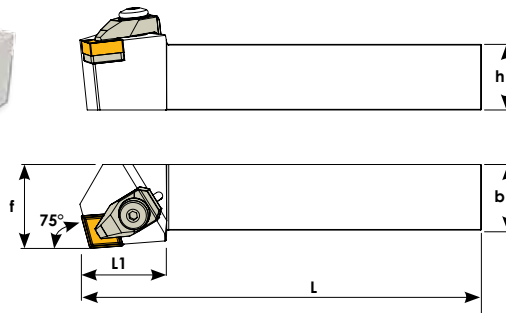

Sipariş Kodu Order Code Best.-Nr.	Stok/Stock/Lager	Ürün Kodu Product Code Produkt-Code	Ölçüler (mm) Dimensions (mm) Abmessungen (mm)					Kullanılan Uç Insert WSP	Altılık Shim U-Platte	Altılık Cıvatası Shim Screw U-Platte Schraube	Baskı Kepli Clamp Spann pratze	Baskı Cıvatası Locking Screw Verriegelungs Schraube	Yay Spring Feder	Pul Washer U-Scheibe	Anahtar Allen Key Inbuss-Schlüssel
			L	L1	h	f	b								
D116-1	●	DCKNR 2525 M12	150	30	25	32	25	CNMG 1204	TA016	TC038 M4x10	BK020	TC044 M6	BY040	BSP030	4 Allen
D162-3	●	DCKNR 2525 M16	150	40	25	32	25	CNMG 1606	TA022	TC095 M5x11,8	BK018				

93° DDUNR

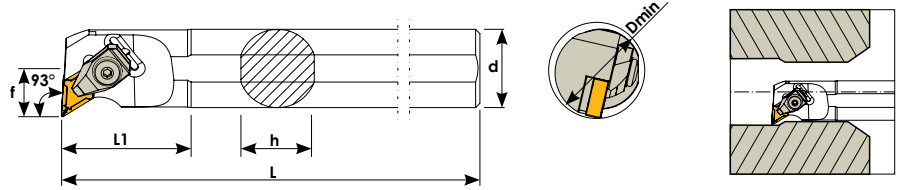

Sipariş Kodu Order Code Best.-Nr.	Stok/stock/Lager	Ürün Kodu Product Code Produkt-Code	Ölçüler (mm) Dimensions(mm) Abmessungen (mm)						Kullanılan Uç Insert WSP	Baskı Civatası Locking Screw Verriegelungs Schraube	Aflık Shim U-Platte	Aflık Civatası Shim Screw U-Platte Schraube	Baskı Kepi Clamp Spann pratze	Yay Spring Feder	Pul Washer U- Scheibe	Anahtar Allen Key Inbuss-Schlüssel
			Dmin	d	L	L1	f	h								
K408	●	S20R DDUNR 11	30	20	200	50	13	18	DN --1104	TC046 M5	TA030	TC075 M4x11	BK024	BY041	BSP031	3 Allen
K409	●	S25S DDUNR 11	32	25	250	50	17	23								
K410	●	S25S DDUNR 15	32	25	250	50	17	23	DN --1506	TC044 M6	TA014	TC038 M4x10	BK020	BY040	BSP030	4 Allen
K412	●	S32T DDUNR 15	40	32	300	55	22	30								
K414	●	S40T DDUNR 15	50	40	300	60	27	38								
K415	●	S40U DDUNR 15	50	40	350	60	27	38								
K416	●	S50U DDUNR 15	63	50	350	65	35	47								
K417	●	S50X DDUNR 15	63	50	550	65	35	47								
K417-1	●	S60X DDUNR 15	73	60	600	65	37,5	57	DN--1504							
K411	●	S25S DDUNR 15	32	25	250	50	17	23								
K413	●	S32T DDUNR 15	40	32	300	55	22	30								



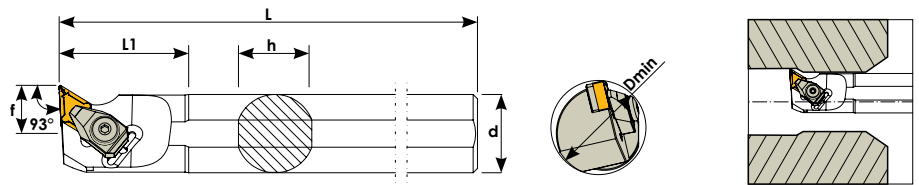

93° DDUNL

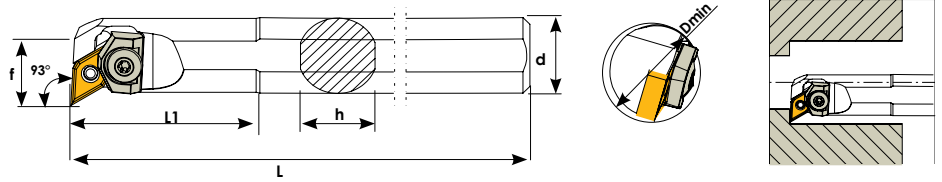

Sipariş Kodu Order Code Best.-Nr.	Stok/stock/Lager	Ürün Kodu Product Code Produkt-Code	Ölçüler (mm) Dimensions(mm) Abmessungen (mm)						Kullanılan Uç Insert WSP	Baskı Civatası Locking Screw Verriegelungs Schraube	Aflık Shim U-Platte	Aflık Civatası Shim Screw U-Platte Schraube	Baskı Kepi Clamp Spann pratze	Yay Spring Feder	Pul Washer U- Scheibe	Anahtar Allen Key Inbuss-Schlüssel
			Dmin	d	L	L1	f	h								
K487	●	S20R DDUNL 11	30	20	200	50	13	18	DN --1104	TC046 M5	TA030	TC075 M4x11	BK024	BY041	BSP031	3 Allen
K488	●	S25S DDUNL 11	32	25	250	50	17	23								
K490	●	S25S DDUNL 15	32	25	250	50	17	23	DN --1506	TC044 M6	TA014	TC038 M4x10	BK020	BY040	BSP030	4 Allen
K492	●	S32T DDUNL 15	40	32	300	55	22	30								
K494	●	S40T DDUNL 15	50	40	300	60	27	38								
K496	●	S50U DDUNL 15	63	50	350	65	35	47								







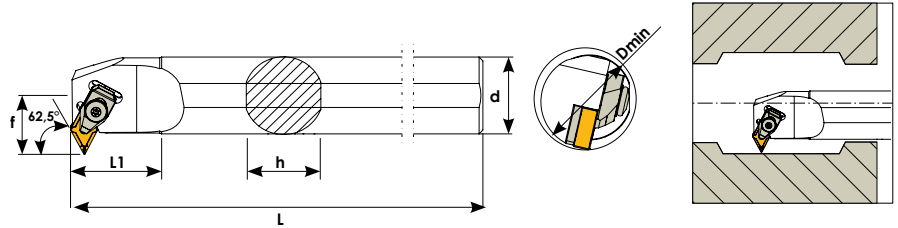
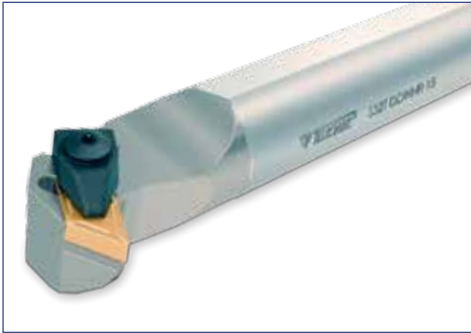

93° MDUNR



Sipariş Kodu Order Code Code Best.-Nr.	Stok/Stock/Lager	Ürün Kodu Product Code Produkt-Code	Ölçüler (mm) Dimensions(mm) Abmessungen (mm)						Kullanılan Uç Insert WSP	Baskı Civatası Locking Screw Verriegelungs Schraube	Altılık Pimi Lock Pin Rohrstift	Baskı Kepi Clamp Spannpratze	Anahtar Allen Key Inbuss-Schlüssel
			Dmin	d	L	L1	f	h					
K408-1	●	S20R MDUNR 11	25	20	200	50	13	18					
									DN --1104	TC046 M5	BSP021	BK017	3 Allen

62,5° DDWNR



Sipariş Kodu Order Code Code Best.-Nr.	Stok/Stock/Lager	Ürün Kodu Product Code Produkt-Code	Ölçüler (mm) Dimensions(mm) Abmessungen (mm)						Kullanılan Uç Insert WSP	Baskı Civatası Locking Screw Verriegelungs Schraube	Altılık Shim U-Platte	Altılık Civatası Shim Screw U-Platte Schraube	Baskı Kepi Clamp Spannpratze	Yay Spring Feder	Pul Washer U-Scheibe	Anahtar Allen Key Inbuss-Schlüssel
			Dmin	d	L	L1	f	h								
K464	●	S32T DDWNR 15	40	32	300	55	24	30								
K466	●	S40T DDWNR 15	50	40	300	50	30	38								
K468	●	S50U DDWNR 15	63	50	350	60	35	47								

107,5° DDQNR

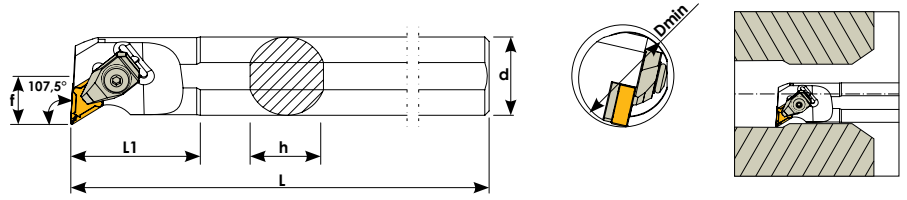

Sipariş Kodu Order Code Best.-Nr.	Stok/Stock/Lager	Ürün Kodu Product Code Produkt-Code	Ölçüler (mm) Dimensions (mm) Abmessungen (mm)						Kullanılan Uç Insert WSP	Baskı Cıvatası Locking Screw Verriegelungs Schraube	Altlık Shim U-Platte	Altlık Cıvatası Shim Screw U-Platte Schraube	Baskı Kepi Clamp Spann pratze	Yay Spring Feder	Pul Washer U-Scheibe	Anahtar Allen Key Inbuss-Schlüssel
			Dmin	d	L	L1	f	h								
K476	●	S25S DDQNR 15	32	25	250	50	17	23	DN-- 1506	TC044 M6	TA014	TC038 M4x10	BK020	BY040	BSP030	4 Allen
K477	●	S32T DDQNR 15	40	32	300	60	22	30								
K478	●	S40T DDQNR 15	50	40	300	60	27	38								
K479	●	S50U DDQNR 15	63	50	350	65	35	47								

107,5° DDQNL

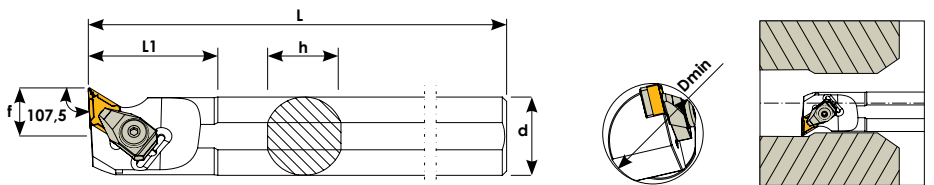

Sipariş Kodu Order Code Best.-Nr.	Stok/Stock/Lager	Ürün Kodu Product Code Produkt-Code	Ölçüler (mm) Dimensions (mm) Abmessungen (mm)						Kullanılan Uç Insert WSP	Baskı Cıvatası Locking Screw Verriegelungs Schraube	Altlık Shim U-Platte	Altlık Cıvatası Shim Screw U-Platte Schraube	Baskı Kepi Clamp Spann pratze	Yay Spring Feder	Pul Washer U-Scheibe	Anahtar Allen Key Inbuss-Schlüssel
			Dmin	d	L	L1	f	h								
K533	●	S25S DDQNL 15	32	25	250	50	17	23	DN --1506	TC044 M6	TA014	TC038 M4x10	BK020	BY040	BSP030	4 Allen
K534	●	S32T DDQNL 15	40	32	300	60	22	30								
K535	●	S40T DDQNL 15	50	40	300	60	27	38								
K536	●	S50U DDQNL 15	63	50	350	65	35	47								

95° DCLNR

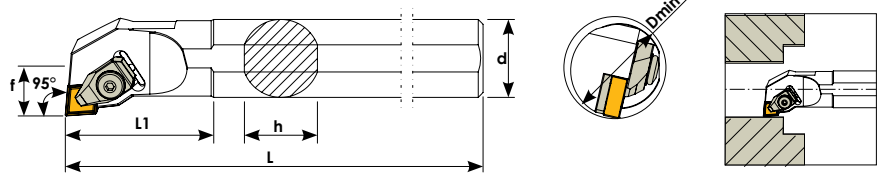

Sipariş Kodu Order Code Best.-Nr.	Stok/Stock/Lager	Ürün Kodu Product Code Produkt-Code	Ölçüler (mm) Dimensions(mm) Abmessungen (mm)						Kullanılan Uç Insert WSP	Baskı Cıvatası Locking Screw Verriegelungs Schraube	Altlık Shim U-Platte	Altlık Cıvatası Shim Screw U-Platte Schraube	Baskı Kepi Clamp Spann pratze	Yay Spring Feder	Pul Washer U-Scheibe	Anahtar Allen Key Inbuss-Schlüssel
			Dmin	d	L	L1	f	h								
K400	●	S25S DCLNR 12	32	25	250	50	17	23	CN --1204	TC044 M6	TA016	TC038 M4x10	BK020	BY040	BSP030	4 Allen
K402	●	S32T DCLNR 12	40	32	300	60	22	30								
K404	●	S40T DCLNR 12	50	40	300	60	27	38								
K406	●	S50U DCLNR 12	63	50	350	60	35	47								

95° DCLNL

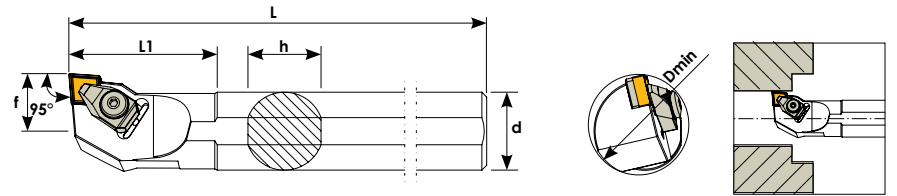

Sipariş Kodu Order Code Best.-Nr.	Stok/Stock/Lager	Ürün Kodu Product Code Produkt-Code	Ölçüler (mm) Dimensions(mm) Abmessungen (mm)						Kullanılan Uç Insert WSP	Baskı Cıvatası Locking Screw Verriegelungs Schraube	Altlık Shim U-Platte	Altlık Cıvatası Shim Screw U-Platte Schraube	Baskı Kepi Clamp Spann pratze	Yay Spring Feder	Pul Washer U-Scheibe	Anahtar Allen Key Inbuss-Schlüssel
			Dmin	d	L	L1	f	h								
K480	●	S25S DCLNL 12	32	25	250	50	17	23	CN --1204	TC044 M6	TA016	TC038 M4x10	BK020	BY040	BSP030	4 Allen
K482	●	S32T DCLNL 12	40	32	300	60	22	30								
K484	●	S40T DCLNL 12	50	40	300	60	27	38								
K486	●	S50U DCLNL 12	63	50	350	60	35	47								

75° DCKNR

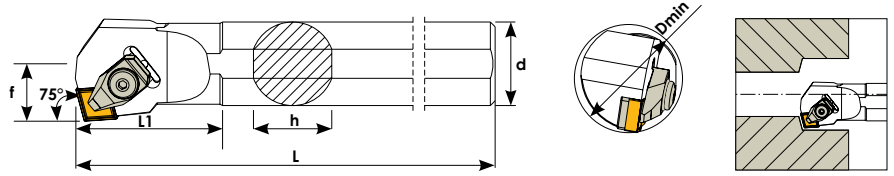

Sipariş Kodu Order Code Best.-Nr.	Stok/Stock/Lager	Ürün Kodu Product Code Produkt-Code	Ölçüler (mm) Dimensions (mm) Abmessungen (mm)						Kullanılan Uç Insert WSP	Baskı Civatası Locking Screw Verriegelungs Schraube	Altlık Shim U-Platte	Altlık Civatası Shim Screw U-Platte Schraube	Baskı Kepi Clamp Spannpratze	Yay Spring Feder	Pul Washer U-Scheibe	Anahtar Allen Key Inbuss-Schlüssel
			Dmin	d	L	L1	f	h								
K401	●	S25S DCKNR 12	32	25	250	55	17	23	CN --1204	TC044 M6	TA016	TC038 M4x10	BK020	BY040	BSP030	4 Allen
K403	●	S32T DCKNR 12	40	32	300	60	22	30								
K405	●	S40T DCKNR 12	50	40	300	65	27	38								



95° DWLNR

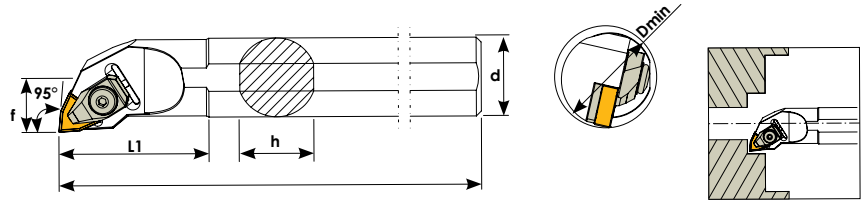

Sipariş Kodu Order Code Best.-Nr.	Stok/Stock/Lager	Ürün Kodu Product Code Produkt-Code	Ölçüler (mm) Dimensions(mm) Abmessungen (mm)							Kullanılan Uç Insert WSP	Baskı Cıvatası Locking Screw Verriegelungs Schraube	Altlık Shim U-Platte	Altlık Cıvatası Shim Screw U-Platte Schraube	Baskı Kepi Clamp Spann pratze	Yay Spring Feder	Pul Washer U-Scheibe	Anahtar Allen Key Inbuss- Schlüssel
			Dmin	d	L	L1	f	h									
K418	●	S25S DWLNR 06	32	25	250	50	17	23	WN--0604	TC046 M5	TA021	TC034 M3x7	BK024	BY041	BSP031	3 Allen	
K420	●	S25S DWLNR 08	32	25	250	50	17	23	WN--0804	TC044 M6	TA020-1	TC083 M5x7	BK020	BY040	BSP030	4 Allen	
K422	●	S32T DWLNR 08	40	32	300	60	22	30									
K424	●	S40T DWLNR 08	50	40	300	60	27	38									
K426	●	S50U DWLNR 08	63	50	350	75	35	47									

95° DWLNL

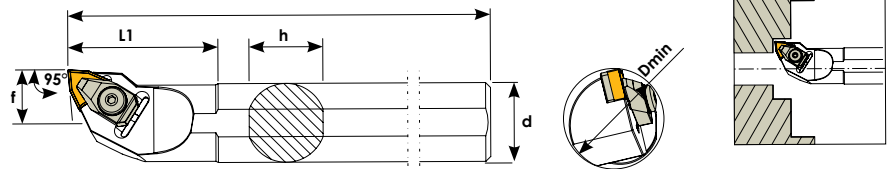

Sipariş Kodu Order Code Best.-Nr.	Stok/Stock/Lager	Ürün Kodu Product Code Produkt-Code	Ölçüler (mm) Dimensions(mm) Abmessungen (mm)							Kullanılan Uç Insert WSP	Baskı Cıvatası Locking Screw Verriegelungs Schraube	Altlık Shim U-Platte	Altlık Cıvatası Shim Screw U-Platte Schraube	Baskı Kepi Clamp Spann pratze	Yay Spring Feder	Pul Washer U-Scheibe	Anahtar Allen Key Inbuss- Schlüssel
			Dmin	d	L	L1	f	h									
K498	●	S25S DWLNL 06	32	25	250	50	17	23	WN--0604	TC046 M5	TA021	TC034 M3x7	BK024	BY041	BSP031	3 Allen	
K500	●	S25S DWLNL 08	32	25	250	50	17	23	WN--0804	TC044 M6	TA020-1	TC083 M5x7	BK020	BY040	BSP030	4 Allen	
K502	●	S32T DWLNL 08	40	32	300	60	22	30									
K504	●	S40T DWLNL 08	50	40	300	60	27	38									
K506	●	S50U DWLNL 08	63	50	350	75	35	47									

95° MWLNR

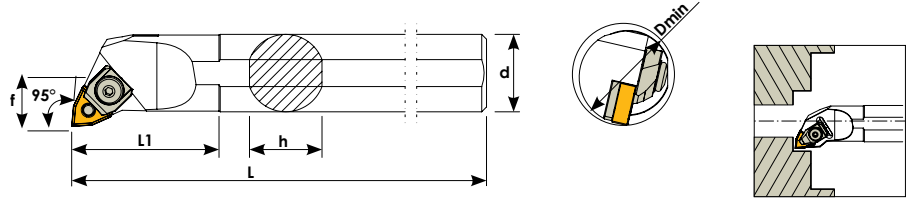

Sipariş Kodu Order Code Best.-Nr.	Stok/Stock/Lager	Ürün Kodu Product Code Produkt-Code	Öçüler (mm) Dimensions(mm) Abmessungen (mm)						Kullanılan Uç Insert WSP	Baskı Civatası Locking Screw Verriegelungs Schraube	Aılık Shim U-Platte	Aılık Pimi Lock Pin Rohrstift	Baskı Kepi Clamp Spann pratze	Yay Spring Feder	Pul Washer U-Scheibe	Anahtar Allen Key Inbuss-Schlüssel
			Dmin	d	L	L1	f	h								
K427	●	S16Q MWLNR 06	20	16	180	40	11	15	WN--0604	TC046 M5	--	BSP020	BK019	BY041	--	3 Allen
K427-1	●	S20R MWLNR 06	25	20	200	50	13	18								
K428	●	S25S MWLNR 08	32	25	250	45	17	23	WN--0804	TC044 M6	TA020	BSP021	BK026	BY040	BSP030	4 Allen
K430	●	S32T MWLNR 08	40	32	300	60	22	30								
K432	●	S40T MWLNR 08	50	40	300	60	27	38								
K434	●	S50U MWLNR 08	63	50	350	65	35	47								

95° MWLNL

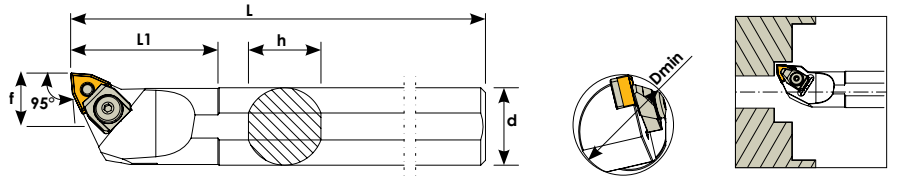

Sipariş Kodu Order Code Best.-Nr.	Stok/Stock/Lager	Ürün Kodu Product Code Produkt-Code	Öçüler (mm) Dimensions(mm) Abmessungen (mm)						Kullanılan Uç Insert WSP	Baskı Civatası Locking Screw Verriegelungs Schraube	Aılık Shim U-Platte	Aılık Pimi Lock Pin Rohrstift	Baskı Kepi Clamp Spann pratze	Yay Spring Feder	Pul Washer U-Scheibe	Anahtar Allen Key Inbuss-Schlüssel
			Dmin	d	L	L1	f	h								
K510	●	S25S MWLNL 08	32	25	250	45	17	23	WN--0804	TC044 M6	TA020	BSP021	BK026	BY040	BSP030	4 Allen
K512	●	S32T MWLNL 08	40	32	300	60	22	30								
K514	●	S40T MWLNL 08	50	40	300	60	27	38								
K516	●	S50U MWLNL 08	63	50	350	65	35	47								

93° MTUNR

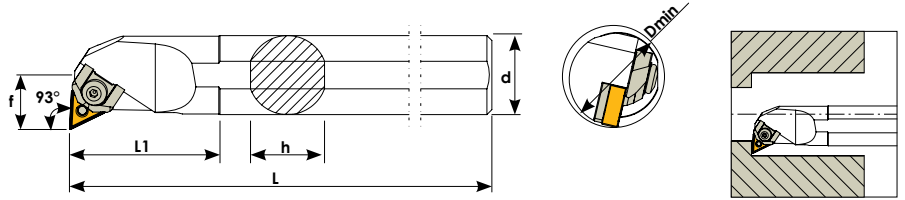

Sipariş Kodu Order Code Best.-Nr.	Stok/Stock/Lager	Ürün Kodu Product Code Produkt-Code	Ölçüler (mm) Dimensions (mm) Abmessungen (mm)						Kullanılan Uç Insert WSP	Baskı Cıvatası Locking Screw Verriegelungs Schraube	Altılık Shim U-Platte	Altılık Pimi Lock Pin Rohrstift	Baskı Kepi Clamp Spann pratze	Yay Spring Feder	Pul Washer U-Scheibe	Anahtar Allen Key Inbuss- Schlüssel
			Dmin	d	L	L1	f	h								
K441	●	S20R MTUNR 16	25	20	200	50	13	18	TNMG 1604	TC046 M5	TA019	BSP020	BK017	BY043	BSP031	3 Allen
K442	●	S25S MTUNR 16	32	25	250	50	17	23								
K444	●	S32T MTUNR 16	40	32	300	60	22	30								
K446	●	S40T MTUNR 16	50	40	300	60	27	38								
K448	●	S50U MTUNR 16	63	50	350	65	35	47								
K450	●	S32T MTUNR 22	40	32	300	60	22	30	TNMG 2204	TC044 M6	TA045	BSP021	BK023	BY040	BSP030	4 Allen
K452	●	S40T MTUNR 22	50	40	300	60	27	38								
K454	●	S50U MTUNR 22	63	50	350	65	35	47								

93° MTUNL

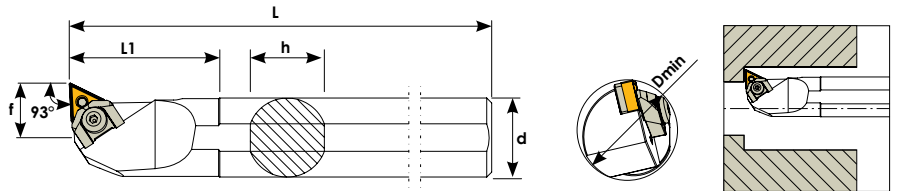

Sipariş Kodu Order Code Best.-Nr.	Stok/Stock/Lager	Ürün Kodu Product Code Produkt-Code	Ölçüler (mm) Dimensions (mm) Abmessungen (mm)						Kullanılan Uç Insert WSP	Baskı Cıvatası Locking Screw Verriegelungs Schraube	Altılık Shim U-Platte	Altılık Pimi Lock Pin Rohrstift	Baskı Kepi Clamp Spann pratze	Yay Spring Feder	Pul Washer U-Scheibe	Anahtar Allen Key Inbuss- Schlüssel
			Dmin	d	L	L1	f	h								
K519	●	S20R MTUNL 16	25	20	200	30	13	18	TNMG 1604	TC046 M5	TA019	BSP020	BK017	BY043	BSP031	3 Allen
K520	●	S25S MTUNL 16	32	25	250	50	17	23								
K522	●	S32T MTUNL 16	40	32	300	60	22	30								
K524	●	S40T MTUNL 16	50	40	300	60	27	38								
K526	●	S50U MTUNL 16	63	50	350	65	35	47								
K528	●	S32T MTUNL 22	40	32	300	60	22	30	TNMG 2204	TC044 M6	TA045	BSP021	BK023	BY040	BSP030	4 Allen
K530	●	S40T MTUNL 22	50	40	300	60	27	38								
K532	●	S50U MTUNL 22	63	50	350	65	35	47								

60° MTENR

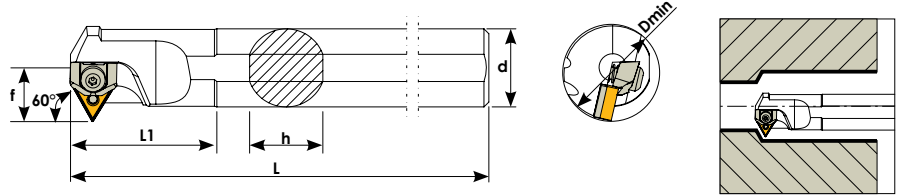

Sipariş Kodu Order Code Best.-Nr.	Stok/Stock/Lager	Ürün Kodu Product Code Produkt-Code	Ölçüler (mm) Dimensions (mm) Abmessungen (mm)						Kullanılan Uç Insert WSP	Baskı Civatası Locking Screw Verriegelungs Schraube	Altlık Shim U-Platte	Altlık Pimi Lock Pin Rohrstift	Baskı Kepi Clamp Spann pratze	Yay Spring Feder	Pul Washer U-Scheibe	Anahtar Allen Key Inbuss-Schlüssel
			Dmin	d	L	L1	f	h								
K456	●	S25S MTENR 16	32	25	250	55	17	23	TNMG 1604	TC046 M5	TA019	BSP 020	BK022	BY043	BSP031	3 Allen
K458	●	S32T MTENR 16	40	32	300	60	22	30								
K460	●	S40T MTENR 16	50	40	300	60	27	38								
K462	●	S50U MTENR 16	63	50	350	70	35	47								

107,5° MTQNR

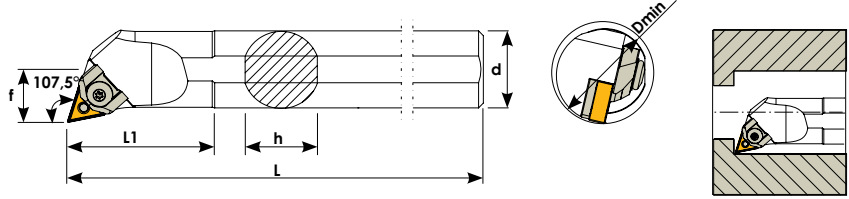

Sipariş Kodu Order Code Best.-Nr.	Stok/Stock/Lager	Ürün Kodu Product Code Produkt-Code	Ölçüler (mm) Dimensions (mm) Abmessungen (mm)						Kullanılan Uç Insert WSP	Baskı Civatası Locking Screw Verriegelungs Schraube	Altılık Shim U-Platte	Altılık Pimi Lock Pin Rohrstift	Baskı Kepi Clamp Spann pratze	Yay Spring Feder	Pul Washer U-Scheibe	Anahtar Allen Key Inbuss-Schlüssel
			Dmin	d	L	L1	f	h								
K365	●	S25S MTQNR 16	32	25	250	50	17	23	TNMG 1604	TC046 M5	TA019	BSP020	BK022	BY043	BSP031	3 Allen
K366	●	S32T MTQNR 16	40	32	300	60	22	30								
K367	●	S40T MTQNR 16	50	40	300	60	27	38								
K368	●	S50U MTQNR 16	63	50	350	65	35	47								

107,5° MTQNL

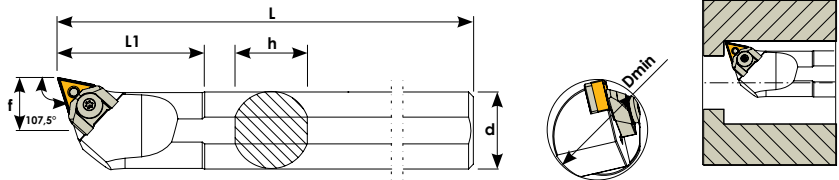

Sipariş Kodu Order Code Best.-Nr.	Stok/Stock/Lager	Ürün Kodu Product Code Produkt-Code	Ölçüler (mm) Dimensions (mm) Abmessungen (mm)						Kullanılan Uç Insert WSP	Baskı Civatası Locking Screw Verriegelungs Schraube	Altılık Shim U-Platte	Altılık Pimi Lock Pin Rohrstift	Baskı Kepi Clamp Spann pratze	Yay Spring Feder	Pul Washer U-Scheibe	Anahtar Allen Key Inbuss-Schlüssel
			Dmin	d	L	L1	f	h								
K537	●	S25S MTQNL 16	32	25	250	50	17	23	TNMG 1604	TC046 M5	TA019	BSP020	BK022	BY043	BSP031	3 Allen
K538	●	S32T MTQNL 16	40	32	300	60	22	30								
K539	●	S40T MTQNL 16	50	40	300	60	27	38								
K540	●	S50U MTQNL 16	63	50	350	65	35	47								

93° CKUNR

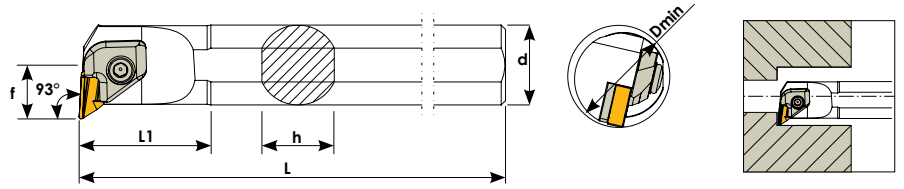

Sipariş Kodu Order Code Best.-Nr.	Stok/Stock/Lager	Ürün Kodu Product Code Produkt-Code	Ölçüler (mm) Dimensions (mm) Abmessungen (mm)						Kullanılan Uç Insert WSP	Baskı Civatası Locking Screw Verriegelungs Schraube	Altık Shim U-Platte	Altık Civatası Shim Screw U-Platte Schraube	Baskı Kepi Clamp Spann pratze	Yay Spring Feder	Pul Washer U-Scheibe	Anahtar Allen Key Inbus-Schlüssel
			Dmin	d	L	L1	f	h								
K750	●	S25T CKUNR 16	32	25	300	52	19	23	KNUX 1604	TC044 M6	TA048	TC036 M3x10	BK030	BY042	BSP030	4 Allen
K754	●	S32U CKUNR 16	40	32	350	52	21	30								
K756	●	S40V CKUNR 16	50	40	400	55	27	38								
K758	●	S45V CKUNR 16	54	45	400	60	29	41								
K760	●	S50W CKUNR 16	63	50	450	60	35	47								



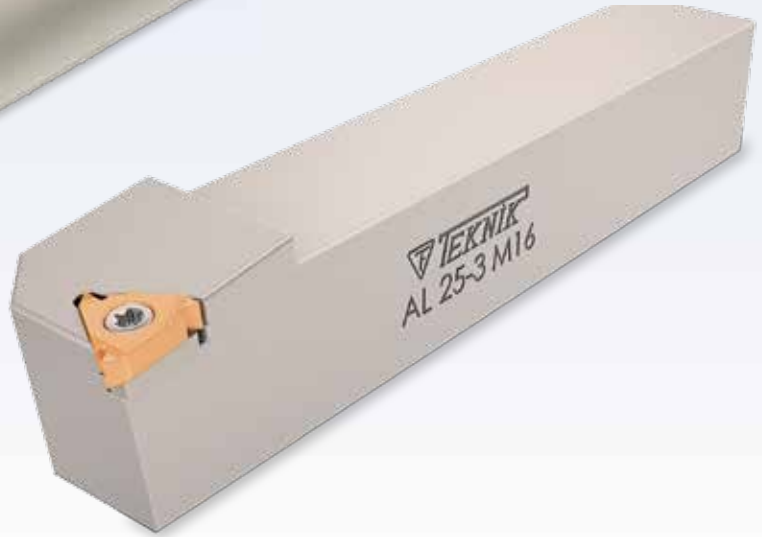

Diş Katerleri
Threading Holders
Klemmhalter
(Außengewinde)

Dış Çap Dış Kateri/R

External Threading Toolholders/R

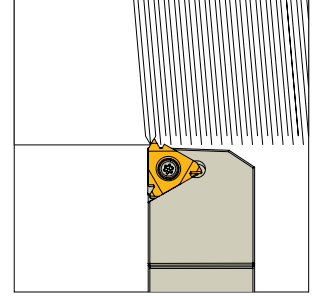
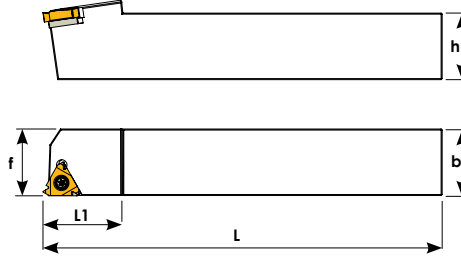
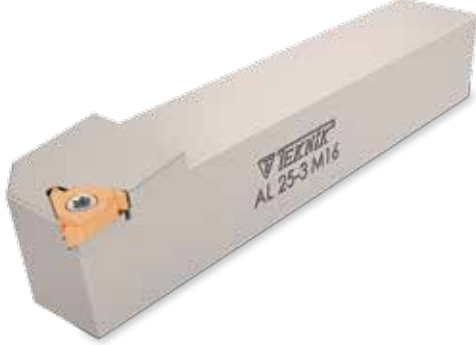

Sipariş Kodu Order Code Best.-Nr.	Stok/Stock/Lager	Ürün Kodu Product Code Produkt-Code	Ölçüler (mm) Dimensions(mm) Abmessungen (mm)					Kullanılan Uç Insert WSP	Sıkma Cıvatası Clamp Screw Torx-Schraube	Altlık Shim U-Platte	Altlık Cıvatası Shim Screw U-Platte Schraube	Anahtar Torx Key Torx-Schlüssel
			L	L1	h	f	b					
D261	●	AL 1212 ER16-J16	110	20	12	16	12	16 ER	TC070 M3,5x11	TA040	TC048 M5	T10
D259	●	AL 1616 ER16-H16	100	22	16	16	16					
D258	●	AL 2020 ER16-K16	125	25	20	20	20					
D260	●	AL 2525 ER16-M16	150	30	25	25	25					
D262	●	AL 3232 ER16-P16	170	30	32	32	32					
D266	●	AL 2525 ER22-M22	150	30	25	25	25	22 ER	TC075 M4X11	---	---	T15

Dış Çap Dış Kateri/L

External Threading Toolholders/L

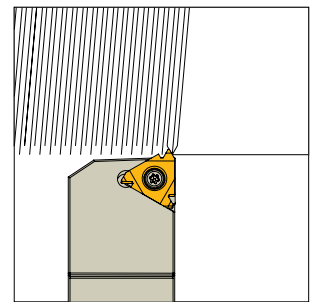
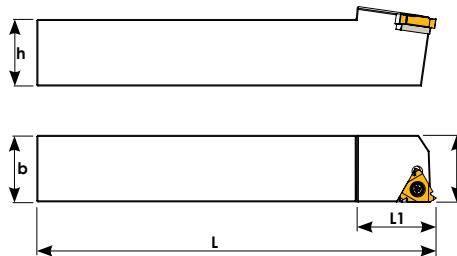
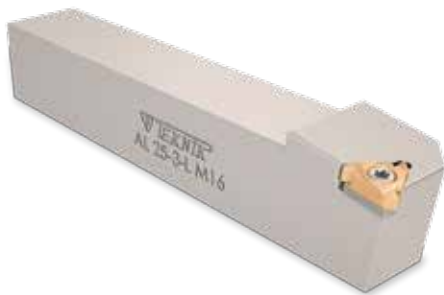



Sipariş Kodu Order Code Best.-Nr.	Stok/Stock/Lager	Ürün Kodu Product Code Produkt-Code	Ölçüler (mm) Dimensions(mm) Abmessungen (mm)					Kullanılan Uç Insert WSP	Sıkma Cıvatası Clamp Screw Torx-Schraube	Altlık Shim U-Platte	Altlık Cıvatası Shim Screw U-Platte Schraube	Anahtar Torx Key Torx-Schlüssel
			L	L1	h	f	b					
D268	●	AL 2020 EL16-K16	125	25	20	20	20	16 EL	TC070 M3,5x11	TA040	TC048 M5	T10
D269	●	AL 2525 EL16-M16	150	30	25	25	25					
D266-1	●	AL 2525 EL22-M22	150	30	25	25	25					

İç Çap Diş Kateri/R

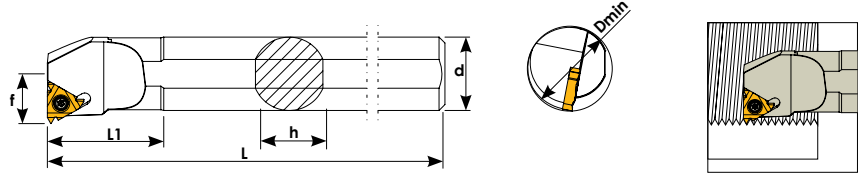
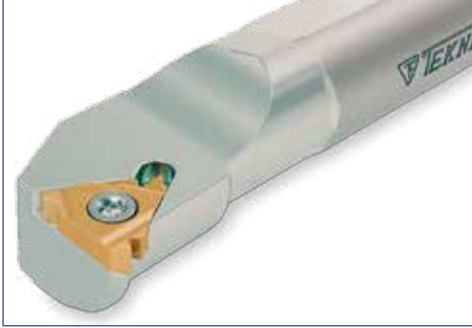
Internal Threading Toolholders/R



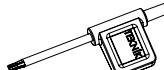

Sipariş Kodu Order Code Best.-Nr.	Stok/Stock/Lager	Ürün Kodu Product Code Produkt-Code	Ölçüler (mm) Dimensions(mm) Abmessungen (mm)						Kullanılan Uç Insert WSP	Sıkma Cıvatası Clamp Screw Torx-Schraube	Anahtar Torx Key Torx-Schlüssel
			Dmin	d	L	L1	f	h			
K348	●	S10J STIR-IR11	12	10	110	20	6	9	11 IR	TC060 M2,5x5,5	T8
K350	●	S12K STIR-IR11	14	12	125	25	7.2	11			
K352	●	S16Q STIR-IR16	20	16	180	40	11	15	16 IR	TC069 M3,5x8,5	T10
K354	●	S20Q STIR-IR16	25	20	180	40	13	18			
K356	●	S25R STIR-IR16	29	25	200	40	16	23			
K358	●	S32T STIR-IR16	36	32	300	60	19.5	30			
K358-1	●	S20Q STIR-IR22	24	20	180	40	14	18	22 IR	TC075 M4x11	T15
K359	●	S25R STIR-IR22	32	25	200	40	17	23			
K360	●	S32T STIR-IR22	36	32	300	60	19,5	30			
K360-1	●	S40T STIR-IR22	45	40	300	60	24.5	38			

İç Çap Diş Kateri/L

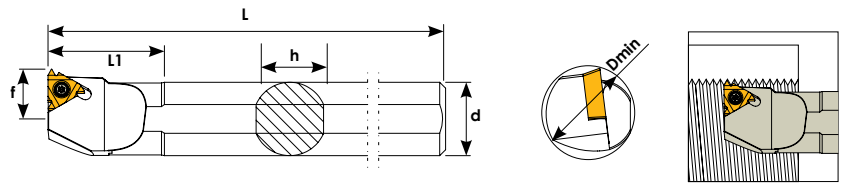
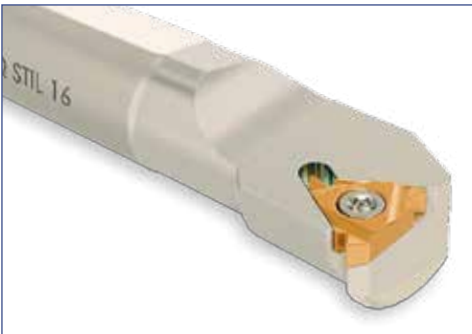
Internal Threading Toolholders/L

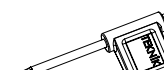

Sipariş Kodu Order Code Best.-Nr.	Stok/Stock/Lager	Ürün Kodu Product Code Produkt-Code	Ölçüler (mm) Dimensions(mm) Abmessungen (mm)						Kullanılan Uç Insert WSP	Sıkma Cıvatası Clamp Screw Torx-Schraube	Anahtar Torx Key Torx-Schlüssel
			Dmin	d	L	L1	f	h			
K361	●	S16Q STIL-IL16	20	16	180	40	11	15	16 IL	TC069 M3,5x8,5	T10
K362	●	S20Q STIL-IL16	25	20	180	40	13	18			
K363	●	S25R STIL-IL16	29	25	200	40	16	23			

Dış Çap Dış Kateri/R

External Threading Toolholders/R

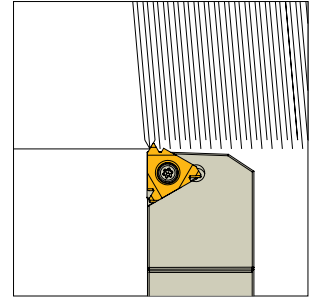
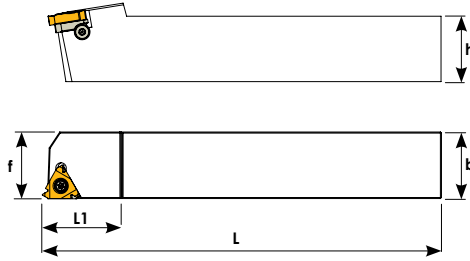

Sipariş Kodu Order Code Best.-Nr.	Stok/Stock/Lager	Ürün Kodu Product Code Produkt-Code	Ölçüler (mm) Dimensions (mm) Abmessungen (mm)					Kullanılan Uç Insert WSP	Sıkma Civatası Clamp Screw Torx-Schraube	Altılık Shim U-Platte	Pul Washer U-Scheibe	Altılık Civatası Shim Screw U-Platte Schraube	Anahtar Torx Key Torx-Schlüssel
			L	L1	h	f	b						
D500	●	TAL 1212 ER16-J16	110	22	12	16	12	16 ER	TC070 M3,5x11	TA061	BSP010	TC062 M3	T10
D501	●	TAL 1616 ER16-H16	100	25	16	16	16						
D502	●	TAL 2020 ER16-K16	125	30	20	20	20						
D503	●	TAL 2525 ER16-M16	150	30	25	25	25						
D504	●	TAL 3232 ER16 P16	170	30	32	32	32						
D505	●	TAL 2525 ER22-M22	150	30	25	25	25	22 ER	TC076 M4x12,5	TA062	TC062 M3	T15	
D506	●	TAL 3232 ER22-P22	170	36	32	32	32						

Dış Çap Dış Kateri/L

External Threading Toolholders/L

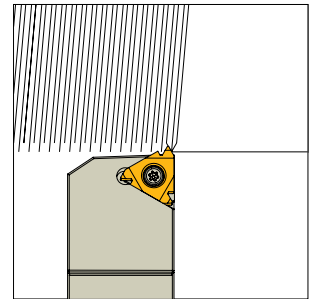

Sipariş Kodu Order Code Best.-Nr.	Stok/Stock/Lager	Ürün Kodu Product Code Produkt-Code	Ölçüler (mm) Dimensions (mm) Abmessungen (mm)					Kullanılan Uç Insert WSP	Sıkma Civatası Clamp Screw Torx-Schraube	Altılık Shim U-Platte	Pul Washer U-Scheibe	Altılık Civatası Shim Screw U-Platte Schraube	Anahtar Torx Key Torx-Schlüssel
			L	L1	h	f	b						
D508	●	TAL 1212-L EL16-J16	110	22	12	16	12	16 EL	TC070 M3,5x11	TA060	BSP010	TC062 M3	T10
D509	●	TAL 1616-L EL16-H16	100	25	16	16	16						
D510	●	TAL 2020-L EL16-K16	125	30	20	20	20						
D511	●	TAL 2525-L EL16-M16	150	30	25	25	25						
D512	●	TAL 3232-L EL16 P16	150	30	32	32	32						
D513	●	TAL 2525-L E22-M22	150	30	25	25	25	22 EL	TC076 M4x12,5	TA063	TC062 M3	T15	
D515	●	TAL 3232-L EL22-P22	170	36	32	32	32						

İç Çap Diş Kateri/R Internal Threading Toolholders/R

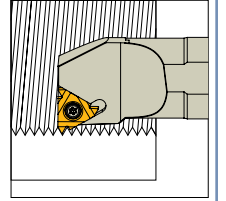
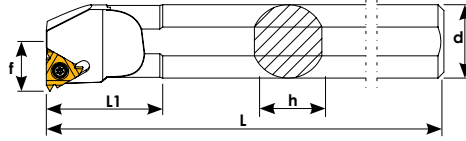

Sipariş Kodu Order Code Best.-Nr.	Stok/Stock/Lager	Ürün Kodu Product Code Produkt-Code	Ölçüler (mm) Dimensions(mm) Abmessungen (mm)						Kullanılan Uç Insert WSP	Sıkma Civatası Clamp Screw Torx-Schraube	Altlık Shim U-Platte	Pul Washer U-Scheibe	Altlık Civatası Shim Screw U-Platte Schraube	Anahtar Torx Key Torx-Schlüssel
			Dmin	d	L	L1	f	h						
K338	●	S20Q TTIR-IR16	24	20	180	40	13,4	18	16 IR	TC070 M3,5x8,5	TA060	BSP010	TC062 M3	T10
K339	●	S25R TTIR-IR16	29	25	200	45	16,1	23						
K340	●	S32T TTIR-IR16	39	32	300	60	21,5	30						
K341	●	S40T TTIR-IR16	45	40	300	60	24,5	38						
K343	●	S25R TTIR-IR22	30	25	200	45	16,1	23	22 IR	TC075 M4x11	TA063	BSP010	TC062 M3	T15
K344	●	S32T TTIR-IR22	39	32	300	40	22	30						
K345	●	S40T TTIR-IR22	50	40	300	60	24,5	38						

İç Çap Diş Kateri/L Internal Threading Toolholders/L

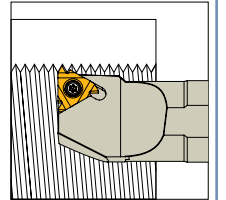
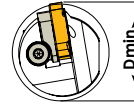
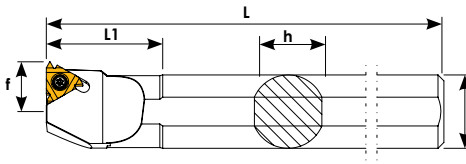

Sipariş Kodu Order Code Best.-Nr.	Stok/Stock/Lager	Ürün Kodu Product Code Produkt-Code	Ölçüler (mm) Dimensions(mm) Abmessungen (mm)						Kullanılan Uç Insert WSP	Sıkma Civatası Clamp Screw Torx-Schraube	Altlık Shim U-Platte	Pul Washer U-Scheibe	Altlık Civatası Shim Screw U-Platte Schraube	Anahtar Torx Key Torx-Schlüssel
			Dmin	d	L	L1	f	h						
K330	●	S20Q TTIL-IL16	24	20	180	40	13,4	18	16 IL	TC070 M3,5x8,5	TA061	BSP010	TC062 M3	T10
K331	●	S25R TTIL-IL16	29	25	200	45	16,1	23						
K332	●	S32T TTIL-IL16	39	32	300	60	21,5	30						
K333	●	S40T TTIL-IL16	45	40	300	60	24,5	38						
K334	●	S25R TTIL-IL22	30	25	200	45	16,1	23	22 IL	TC075 M4x11	TA062	BSP010	TC062 M3	T15
K335	●	S32T TTIL-IL22	39	32	300	40	22	30						
K336	●	S40T TTIL-IL22	50	40	300	60	24,5	38						

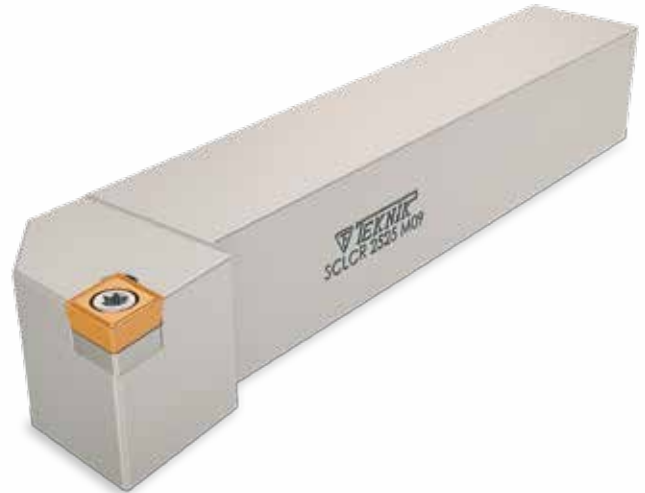
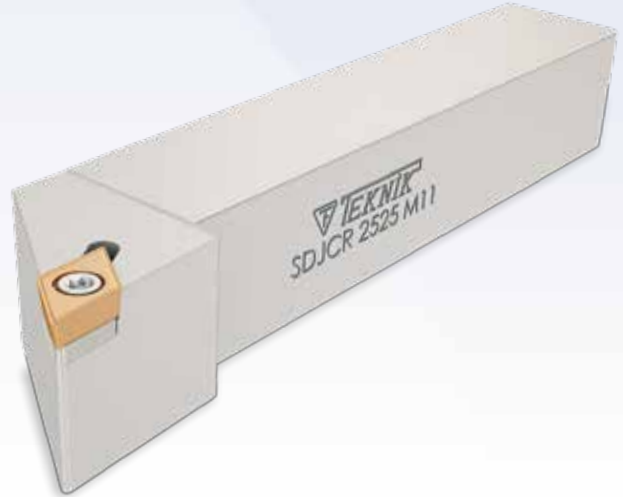

S Sistem Kater
S System

95° SCLCR

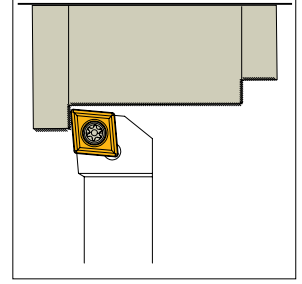
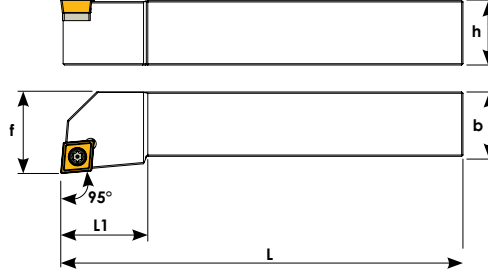

Sipariş Kodu Order Code Best.-Nr.	Stok/Stock/Lager	Ürün Kodu Product Code Produkt-Code	Ölçüler (mm) Dimensions(mm) Abmessungen (mm)					Kullanılan Uç Insert WSP	Sıkma Cıvatası Clamp Screw Torx-Schraube	Altlık Shim U-Platte	Altlık Cıvatası Shim Screw U-Platte Schraube	Anahtar Torx Key Torx-Schlüssel
			L	L1	h	f	b					
D398	●	SCLCR 1010 J06	110	10	10	12	10	CC-- 0602	TC060 M2,5x5,5	---	---	T8
D400	●	SCLCR 1212 J09	110	16	12	16	12	CC-- 09T3	TC068 M3,5x11	TA015	TC048 M5	T15
D401	●	SCLCR 1616 H09	100	20	16	20	16					
D402	●	SCLCR 2020 K09	125	25	20	25	20					
D403	●	SCLCR 2525 M09	150	25	25	32	25					

95° SCLCL

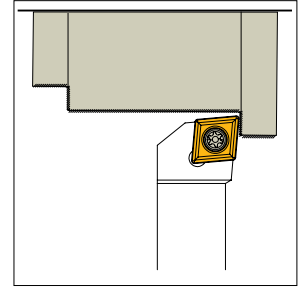
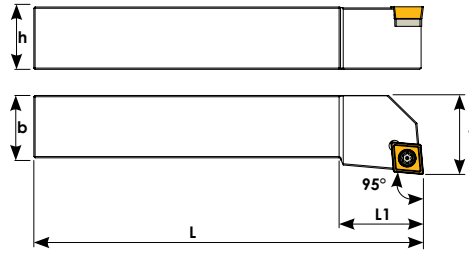

Sipariş Kodu Order Code Best.-Nr.	Stok/Stock/Lager	Ürün Kodu Product Code Produkt-Code	Ölçüler (mm) Dimensions(mm) Abmessungen (mm)					Kullanılan Uç Insert WSP	Sıkma Cıvatası Clamp Screw Torx-Schraube	Altlık Shim U-Platte	Altlık Cıvatası Shim Screw U-Platte Schraube	Anahtar Torx Key Torx-Schlüssel
			L	L1	h	f	b					
D404	●	SCLCL 1010 J06	110	10	10	12	10	CC-- 0602	TC060 M2,5x5,5	---	---	T8
D405	●	SCLCL 1212 J09	110	16	12	16	12	CC-- 09T3	TC068 M3,5x11	TA015	TC048 M5	T15
D406	●	SCLCL 1616 H09	100	20	16	20	16					
D407	●	SCLCL 2020 K09	125	25	20	25	20					
D408	●	SCLCL 2525 M09	150	25	25	32	25					

90° SCACR

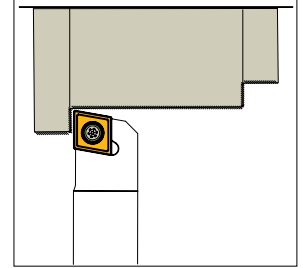
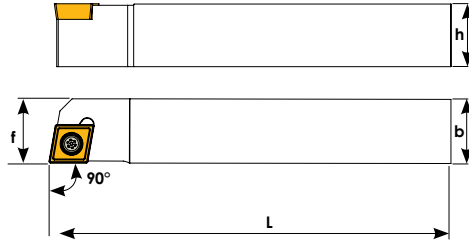

Sipariş Kodu Order Code Best.-Nr.	Stok/Stock/Lager	Ürün Kodu Product Code Produkt-Code	Ölçüler (mm) Dimensions(mm) Abmessungen (mm)				Kullanılan Uç Insert WSP	Altılık Shim U-Platte	Altılık Cıvatası Shim Screw U-Platte Schraube	Sıkma Cıvatası Clamp Screw Torx-Schraube	Anahtar Torx Key Torx-Schlüssel
			L	h	f	b					
D411	●	SCACR 1010 J06-F	110	10	10	10	CCMT 0602	---	---	TC060 M2,5x5,5	T8
D412	●	SCACR 1212 J09-F	110	12	12	12	CCMT 09T3	TA015	TC048 M5	TC067 M3,5x9	T15
D414	●	SCACR 1616 H09-F	100	16	16	16				TC068 M3,5x11	
D416	●	SCACR 2020 K09-F	125	20	20	20					

95° SCLCR

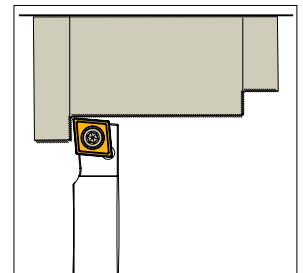
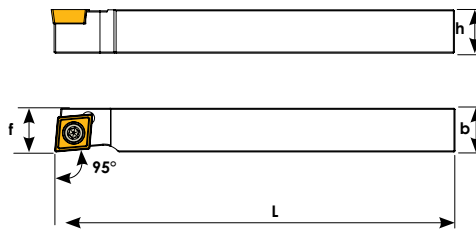

Sipariş Kodu Order Code Best.-Nr.	Stok/Stock/Lager	Ürün Kodu Product Code Produkt-Code	Ölçüler (mm) Dimensions(mm) Abmessungen (mm)				Kullanılan Uç Insert WSP	Altılık Shim U-Platte	Altılık Cıvatası Shim Screw U-Platte Schraube	Sıkma Cıvatası Clamp Screw Torx-Schraube	Anahtar Torx Key Torx-Schlüssel
			L	h	f	b					
D422	●	SCLCR 1010 J06-F	110	10	10	10	CCMT 0602	---	---	TC060 M2,5x5,5	T8
D424	●	SCLCR 1212 J06-F	110	12	12	12					
D426	●	SCLCR 1212 J09-F	110	12	12	12	CCMT 09T3	TA015	TC048 M5	TC068 M3,5x1	T15
D428	●	SCLCR 1616 H09-F	100	16	16	16					
D430	●	SCLCR 2020 K09-F	125	20	20	20					

93° SDJCR

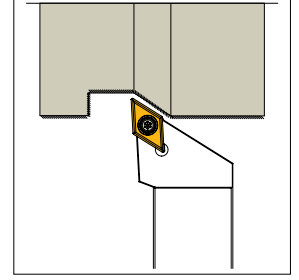
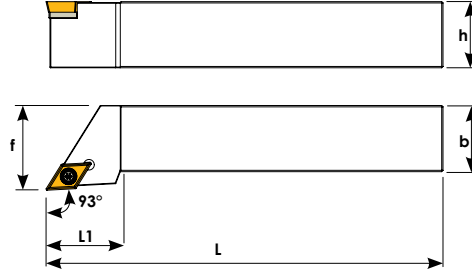

Sipariş Kodu Order Code Best.-Nr.	Stok/Stock/Lager	Ürün Kodu Product Code Produkt-Code	Ölçüler (mm) Dimensions (mm) Abmessungen (mm)					Sıkma Cıvatası Clamp Screw Torx-Schraube	Kullanılan Uç Insert WSP	Altlık Shim U-Platte	Altlık Cıvatası Shim Screw U-Platte Schraube	Anahtar Torx Key Torx-Schlüssel
			L	L1	h	f	b					
D220	●	SDJCR 1010 J07	110	15	10	12	10	TC060 M2,5x5,5	DCMT 0702	---	---	T8
D222	●	SDJCR 1212 J11	110	20	12	16	12	TC067 M3,5x9	DCMT 11T3	---	---	T15
D224	●	SDJCR 1616 H11	100	25	16	20	TC068 M3,5x11	TA030		TC048 M5		
D226	●	SDJCR 2020 K11	125	25	20	25					20	
D228	●	SDJCR 2525 M11	150	30	25	32					25	



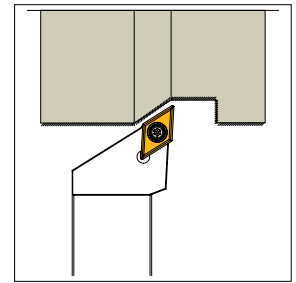
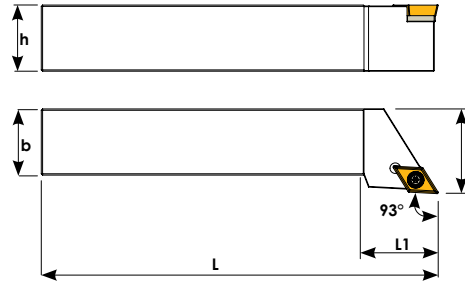

93° SDJCL

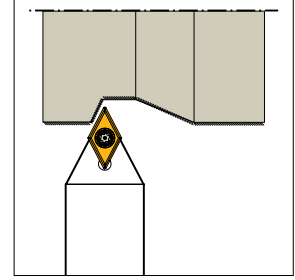
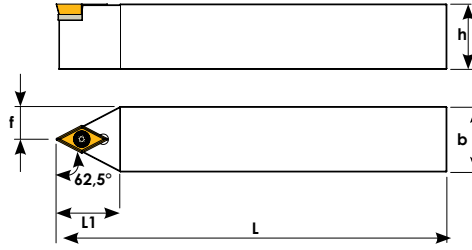

Sipariş Kodu Order Code Best.-Nr.	Stok/Stock/Lager	Ürün Kodu Product Code Produkt-Code	Ölçüler (mm) Dimensions (mm) Abmessungen (mm)					Sıkma Cıvatası Clamp Screw Torx-Schraube	Kullanılan Uç Insert WSP	Altlık Shim U-Platte	Altlık Cıvatası Shim Screw U-Platte Schraube	Anahtar Torx Key Torx-Schlüssel
			L	L1	h	f	b					
D360	●	SDJCL 1010 J07	110	15	10	12	10	TC060 M2,5x5,5	DCMT 0702	---	---	T8
D362	●	SDJCL 1212 J11	110	20	12	16	12	TC067 M3,5x9	DCMT 11T3	---	---	T15
D364	●	SDJCL 1616 H11	100	25	16	20	TC068 M3,5x11	TA030		TC048 M5		
D366	●	SDJCL 2020 K11	125	25	20	25					20	
D368	●	SDJCL 2525 M11	150	30	25	32					25	

62,5° SDNCN



Sipariş Kodu Order Code Best.-Nr.	Stok/Stock/Lager	Ürün Kodu Product Code Produkt-Code	Ölçüler (mm) Dimensions (mm) Abmessungen (mm)					Kullanılan Uç Insert WSP	Sıkma Cıvatası Clamp Screw Torx-Schraube	Aitlik Shim U-Platte	Aitlik Cıvatası Shim Screw U-Platte Schraube	Anahtar Torx Key Torx-Schlüssel
			L	L1	h	f	b					
D117	●	SDNCN 1010 J07	110	15	10	5	10	DC-- 0702	TC060 M2,5x5,5	---	---	T8
D118	●	SDNCN 1212 J11	110	25	12	6	12	DC-- 11T3	TC067 M3,5x9	---	---	T15
D120	●	SDNCN 1616 H11	100	25	16	8	16	DC-- 11T3	TC068 M3,5x11	TA030	TC048 M5	
D122	●	SDNCN 2020 K11	125	25	20	10	20					
D124	●	SDNCN 2525 M11	150	25	25	12.5	25					



90° SDACR

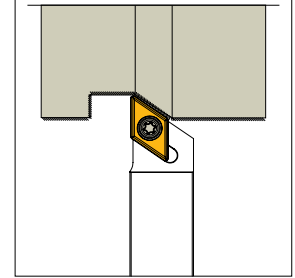
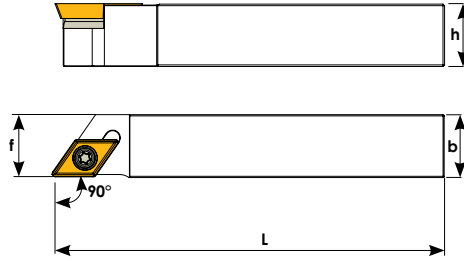

Sipariş Kodu Order Code Besf.-Nr.	Stok/Stock/Lager	Ürün Kodu Product Code Produkt-Code	Ölçüler (mm) Dimensions (mm) Abmessungen (mm)				Kullanılan Uç Insert WSP	Sıkma Civatası Clamp Screw Torx-Schraube	Altlık Shim U-Platte	Altlık Civatası Shim Screw U-Platte Schraube	Anahtar Torx Key Torx-Schlüssel
			L	h	f	b					
D434	●	SDACR 1010 J07-F	110	10	10	10	DCMT 0702	TC060 M2,5x5,5	---	---	T8
D436	●	SDACR 1212 J07-F	110	12	12	12					
D438	●	SDACR 1616 H07-F	100	16	16	16					
D440	●	SDACR 1212 J11-F	110	12	12	12	DCMT 11T3	TC068 M3,5x11	TA030	TC048 M5	T15
D442	●	SDACR 1616 H11-F	100	16	16	16					
D444	●	SDACR 2020 K11-F	125	20	20	20					

93° SDJCR

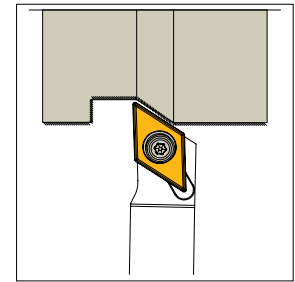
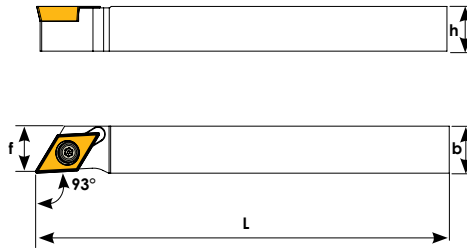

Sipariş Kodu Order Code Besf.-Nr.	Stok/Stock/Lager	Ürün Kodu Product Code Produkt-Code	Ölçüler (mm) Dimensions (mm) Abmessungen (mm)				Kullanılan Uç Insert WSP	Sıkma Civatası Clamp Screw Torx-Schraube	Anahtar Torx Key Torx-Schlüssel
			L	h	f	b			
D452	●	SDJCR 1010 J07-F	110	10	10	10	DCMT 0702	TC060 M2,5x5,5	T8
D454	●	SDJCR 1212 J07-F	110	12	12	12			
D456	●	SDJCR 1616 H07-F	100	16	16	16			
D457	●	SDJCR 1212 J11-F	110	12	12	12	DCMT 11T3	TC067 M3,5x9	

107,5° SDHCR

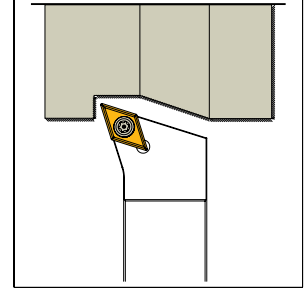
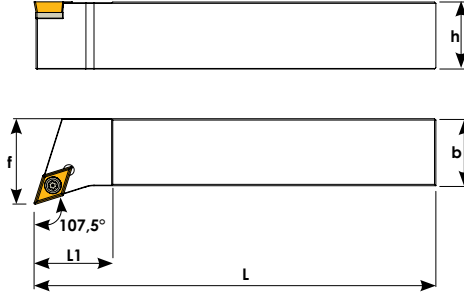

Sipariş Kodu Order Code Best.-Nr.	Stok/Stock/Lager	Ürün Kodu Product Code Produkt-Code	Ölçüler (mm) Dimensions (mm) Abmessungen (mm)					Kullanılan Uç Insert WSP	Sıkma Civatası Clamp Screw Torx-Schraube	Aitlik Shim U-Platte	Aitlik Civatası Shim Screw U-Platte Schraube	Anahtar Torx Key Torx-Schlüssel
			L	L1	h	f	b					
D250	●	SDHCR 2020 K11	125	25	20	25	20	DCMT 11T3	TC068 M3,5x11	TA030	TC048 M5	T15
D252	●	SDHCR 2525 M11	150	25	25	32	25					

107,5° SDHCL

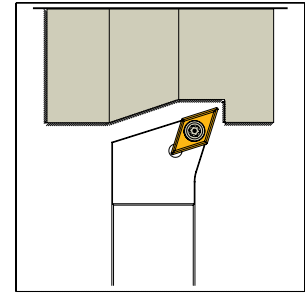
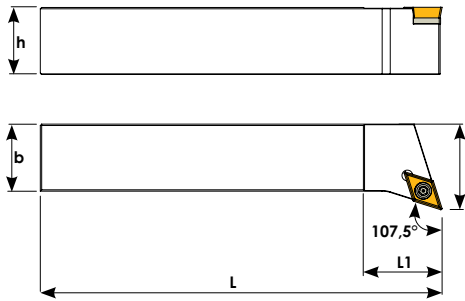

Sipariş Kodu Order Code Best.-Nr.	Stok/Stock/Lager	Ürün Kodu Product Code Produkt-Code	Ölçüler (mm) Dimensions (mm) Abmessungen (mm)					Kullanılan Uç Insert WSP	Sıkma Civatası Clamp Screw Torx-Schraube	Aitlik Shim U-Platte	Aitlik Civatası Shim Screw U-Platte Schraube	Anahtar Torx Key Torx-Schlüssel
			L	L1	h	f	b					
D350	●	SDHCL 2020 K11	125	25	20	25	20	DCMT 11T3	TC068 M3,5x11	TA030	TC048 M5	T15
D352	●	SDHCL 2525 M11	150	25	25	32	25					

107,5° SVHCR

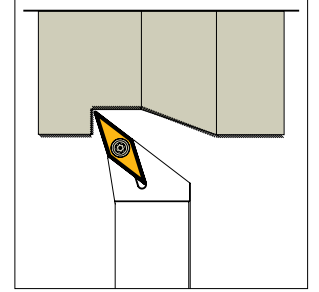
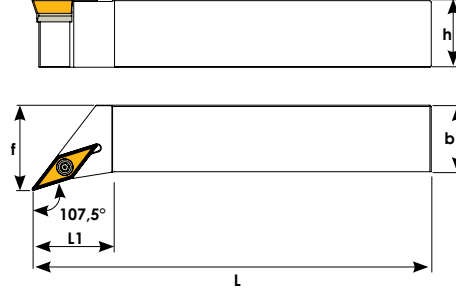

Sipariş Kodu Order Code Best.-Nr.	Stok/Stock/Lager	Ürün Kodu Product Code Produkt-Code	Ölçüler (mm) Dimensions (mm) Abmessungen (mm)					Kullanılan Uç Insert WSP	Sıkma Civatası Clamp Screw Torx-Schraube	Altlık Shim U-Platte	Altlık Civatası Shim Screw U-Platte Schraube	Anahtar Torx Key Torx-Schlüssel
			L	L1	h	f	b					
D254	●	SVHCR 2020 K16	125	30	20	25	20	VCMT 1604	TC068 M3,5x11	TA034	TC048 M5	T15
D256	●	SVHCR 2525 M16	150	30	25	32	25					



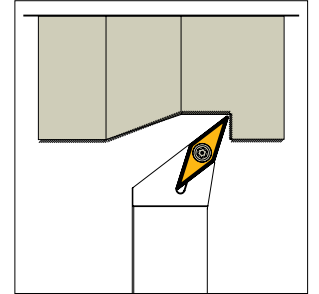
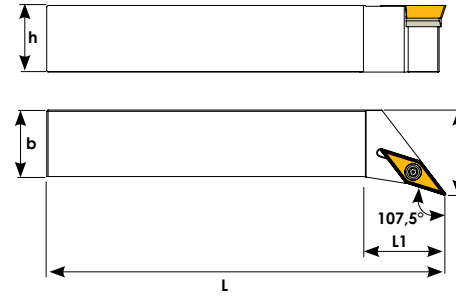

107,5° SVHCL

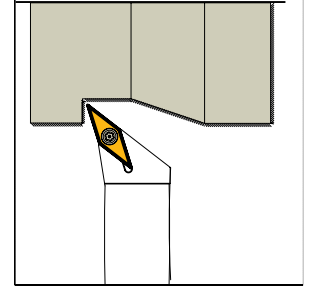
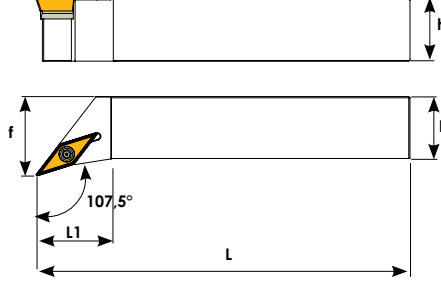

Sipariş Kodu Order Code Best.-Nr.	Stok/Stock/Lager	Ürün Kodu Product Code Produkt-Code	Ölçüler (mm) Dimensions (mm) Abmessungen (mm)					Kullanılan Uç Insert WSP	Sıkma Civatası Clamp Screw Torx-Schraube	Altlık Shim U-Platte	Altlık Civatası Shim Screw U-Platte Schraube	Anahtar Torx Key Torx-Schlüssel
			L	L1	h	f	b					
D354	●	SVHCL 2020 K16	125	30	20	25	20	VCMT 1604	TC068 M3,5x11	TA034	TC048 M5	T15
D356	●	SVHCL 2525 M16	150	30	25	32	25					



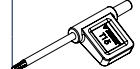

107,5 SVHBR

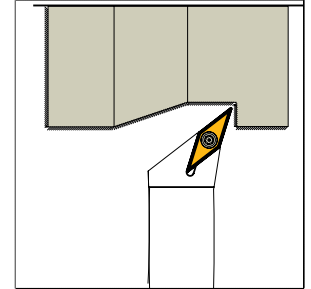
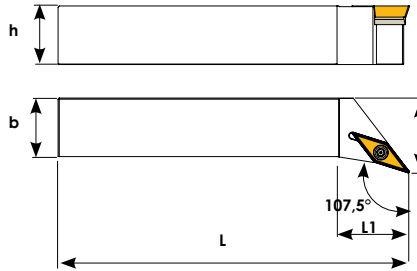

Sipariş Kodu Order Code Best.-Nr.	Stok/Stock/Lager	Ürün Kodu Product Code Produkt-Code	Ölçüler (mm) Dimensions(mm) Abmessungen (mm)					Kullanılan Uç Insert WSP	Sıkma Cıvatası Clamp Screw Torx-Schraube	Altlık Shim U-Platte	Altlık Cıvatası Shim Screw U-Platte Schraube	Anahtar Torx Key Torx-Schlüssel
			L	L1	h	f	b					
D354-1	●	SVHBR 2020 K16	125	30	20	25	20	VBMT 1604	TC068 M3,5x11	TA034	TC048 M5	T15
D356-1	●	SVHBR 2525 M16	150	30	25	32	25					

107,5 SVHBL

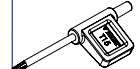

Sipariş Kodu Order Code Best.-Nr.	Stok/Stock/Lager	Ürün Kodu Product Code Produkt-Code	Ölçüler (mm) Dimensions(mm) Abmessungen (mm)					Kullanılan Uç Insert WSP	Sıkma Cıvatası Clamp Screw Torx-Schraube	Altlık Shim U-Platte	Altlık Cıvatası Shim Screw U-Platte Schraube	Anahtar Torx Key Torx-Schlüssel
			L	L1	h	f	b					
D355	●	SVHBL 2020 K16	125	30	20	25	20	VBMT 1604	TC068 M3,5x11	TA034	TC048 M5	T15
D356-2	●	SVHBL 2525 M16	150	30	25	32	25					

93° SVJBR

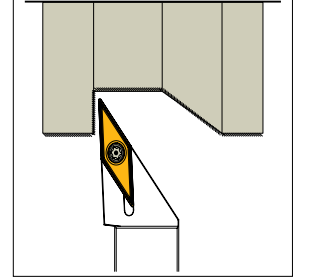
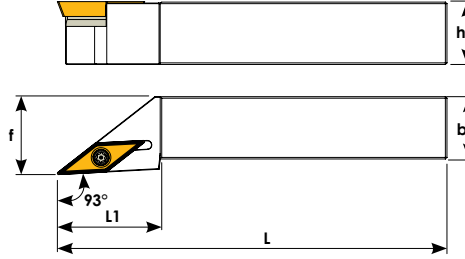

Sipariş Kodu Order Code Code Best.-Nr.	Stok/Stock/Lager	Ürün Kodu Product Code Produkt-Code	Ölçüler (mm) Dimensions(mm) Abmessungen (mm)						Kullanılan Uç Insert WSP	Sıkma Cıvatası Clamp Screw Torx-Schraube	Aitlik Shim U-Platte	Aitlik Cıvatası Shim Screw U-Platte Schraube	Anahtar Torx Key Torx-Schlüssel
			L	L1	h	f	b						
D230	●	SVJBR 1010 J11	110	21	10	12	10	VBMT 1103	TC060 M2,5x5,5	---	---	T8	
D232	●	SVJBR 1212 J11	110	21	12	16	12						
D234	●	SVJBR 1616 H11	100	25	16	20	16						
D235	●	SVJBR 1616 H16	100	33	16	20	16	VBMT 1604	TC068 M3,5x11	TA034	TC048 M5	T15	
D236	●	SVJBR 2020 K16	125	33	20	25	20						
D238	●	SVJBR 2525 M16	150	40	25	32	25						
D238-1	●	SVJBR 3232 P16	170	40	32	40	32						

93° SVJBL

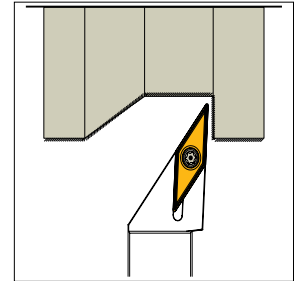
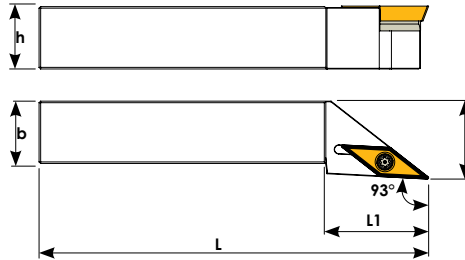

Sipariş Kodu Order Code Code Best.-Nr.	Stok/Stock/Lager	Ürün Kodu Product Code Produkt-Code	Ölçüler (mm) Dimensions(mm) Abmessungen (mm)						Kullanılan Uç Insert WSP	Sıkma Cıvatası Clamp Screw Torx-Schraube	Aitlik Shim U-Platte	Aitlik Cıvatası Shim Screw U-Platte Schraube	Anahtar Torx Key Torx-Schlüssel
			L	L1	h	f	b						
D370	●	SVJBL 1010 J11	110	21	10	12	10	VBMT 1103	TC060 M2,5x5,5	---	---	T8	
D372	●	SVJBL 1212 J11	110	21	12	16	12						
D373	●	SVJBL 1616 H11	100	25	16	20	16						
D374	●	SVJBL 1616 H16	100	33	16	20	16	VBMT 1604	TC068 M3,5x11	TA034	TC048 M5	T15	
D380	●	SVJBL 2020 K16	125	33	20	25	20						
D382	●	SVJBL 2525 M16	150	40	25	32	25						
D382-1	●	SVJBL 3232 P16	170	40	32	40	32						

72,5° SVVBN

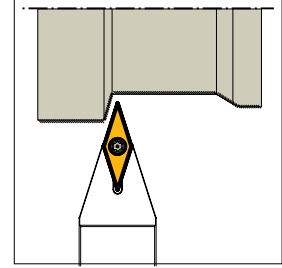
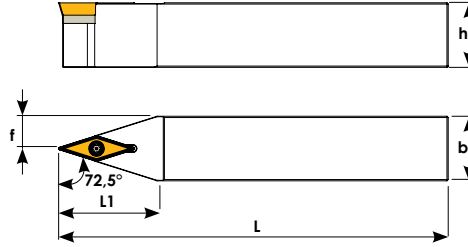

Sipariş Kodu Order Code Best.-Nr.	Stok/Stock/Lager	Ürün Kodu Product Code Produkt-Code	Ölçüler (mm) Dimensions (mm) Abmessungen (mm)					Kullanılan Uç Insert WSP	Sıkma Civatası Clamp Screw Torx-Schraube	Altlık Shim U-Platte	Altlık Civatası Shim Screw U-Platte Schraube	Anahtar Torx Key Torx-Schlüssel
			L	L1	h	f	b					
D131	●	SVVBN 1212 J11	110	25	12	6	12	VBMT 1103	TC060 M2,5x5,5	---	---	T8
D132	●	SVVBN 1616 H16	100	33	16	8	16	VBMT 1604	TC068 M3,5x11	TA034	TC048 M5	T15
D138	●	SVVBN 2020 K16	125	35	20	10	20					
D140	●	SVVBN 2525 M16	150	40	25	12,5	25					



93° SVJBR

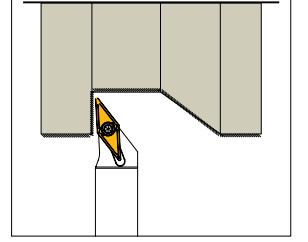
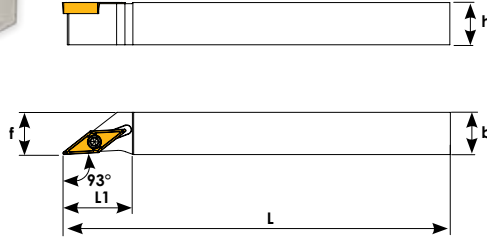

Sipariş Kodu Order Code Best.-Nr.	Stok/Stock/Lager	Ürün Kodu Product Code Produkt-Code	Ölçüler (mm) Dimensions(mm) Abmessungen (mm)					Kullanılan Uç Insert WSP	Sıkma Cıvatası Clamp Screw Torx-Schraube	Anahtar Torx Key Torx-Schlüssel
			L	L1	h	f	b			
D128	●	SVJBR 1010 J11-F	110	22	10	10	10	VBMT 1103	TC060 M2,5x5,5	T8
D129	●	SVJBR 1212 J11-F	110	22	12	12	12			
D130	●	SVJBR 1616 H11-F	100	25	16	16	16			

93° SVJBL

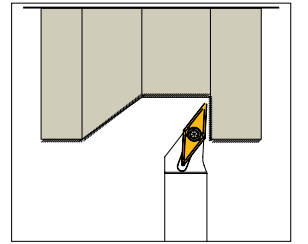
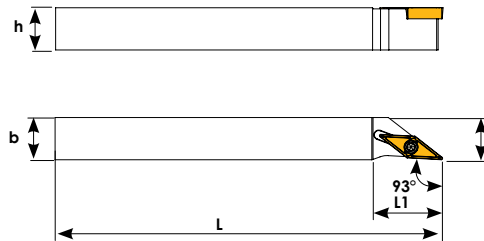

Sipariş Kodu Order Code Best.-Nr.	Stok/Stock/Lager	Ürün Kodu Product Code Produkt-Code	Ölçüler (mm) Dimensions(mm) Abmessungen (mm)					Kullanılan Uç Insert WSP	Sıkma Cıvatası Clamp Screw Torx-Schraube	Anahtar Torx Key Torx-Schlüssel
			L	L1	h	f	b			
D395	●	SVJBL 1010 J11-F	110	22	10	10	10	VBMT 1103	TC060 M2,5x5,5	T8
D396	●	SVJBL 1212 J11-F	110	22	12	12	12			
D397	●	SVJBL 1616 H11-F	100	25	16	16	16			

93° SVJCR

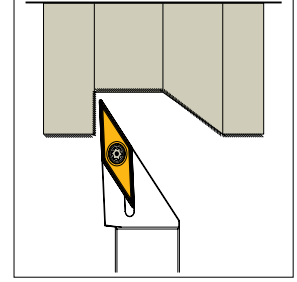
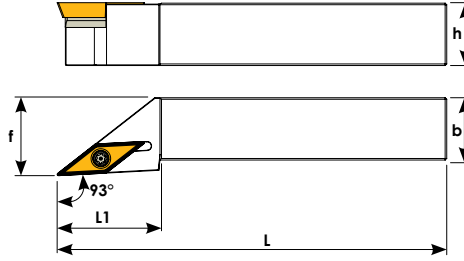

Sipariş Kodu Order Code Best.-Nr.	Stok/Stock/Lager	Ürün Kodu Product Code Produkt-Code	Ölçüler (mm) Dimensions(mm) Abmessungen (mm)					Kullanılan Uç Insert WSP	Sıkma Cıvatası Clamp Screw Torx-Schraube	Aitlik im U-Platte	Aitlik Cıvatası Shim Screw U-Platte Schraube	Anahtar Torx Key Torx-Schlüssel
			L	L1	H	f	b					
D239	●	SVJCR 1010 J11	110	21	10	12	10	VCMT 1103	TC060 M2,5x5,5	---	---	T8
D240	●	SVJCR 1212 J11	110	21	12	16	12					
D241	●	SVJCR 1616 H11	100	25	16	20	16					
D242	●	SVJCR 2020 K11	125	33	20	25	20					
D243	●	SVJCR 2525 M11	150	40	25	32	25	VCMT 1604	TC068 M3,5x11	TA034	TC048 M5	T15
D244	●	SVJCR 1616 H16	100	33	16	20	16					
D246	●	SVJCR 2020 K16	125	33	20	25	20					
D248	●	SVJCR 2525 M16	150	40	25	32	25					

93° SVJCL

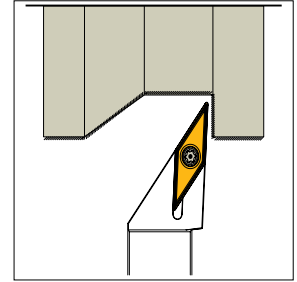
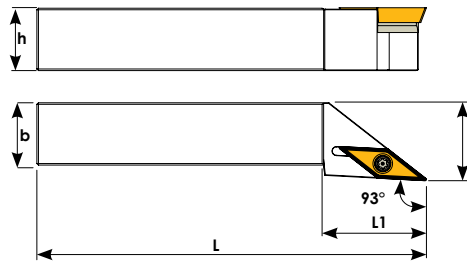

Sipariş Kodu Order Code Best.-Nr.	Stok/Stock/Lager	Ürün Kodu Product Code Produkt-Code	Ölçüler (mm) Dimensions(mm) Abmessungen (mm)					Kullanılan Uç Insert WSP	Sıkma Cıvatası Clamp Screw Torx-Schraube	Aitlik Shim U-Platte	Aitlik Cıvatası Shim Screw U-Platte Schraube	Anahtar Torx Key Torx-Schlüssel
			L	L1	H	f	b					
D383	●	SVJCL 1010 J11	110	21	10	12	10	VCMT 1103	TC060 M2,5x5,5	---	---	T8
D384	●	SVJCL 1212 J11	110	21	12	16	12					
D385	●	SVJCL 1616 H11	100	25	16	20	16					
D386	●	SVJCL 2020 K11	125	33	20	25	20					
D387	●	SVJCL 2525 M11	150	40	25	32	25	VCMT 1604	TC068 M3,5x11	TA034	TC048 M5	T15
D388	●	SVJCL 1616 H16	100	33	16	20	16					
D390	●	SVJCL 2020 K16	125	33	20	25	20					
D392	●	SVJCL 2525 M16	150	40	25	32	25					

90° SVJCR

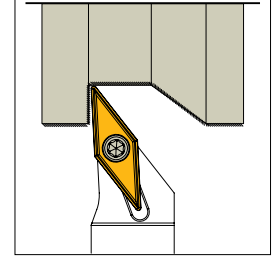
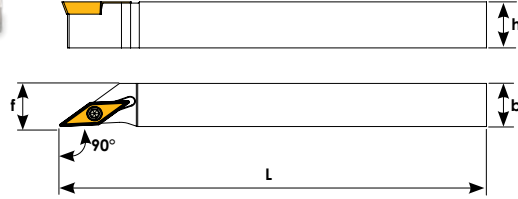

Sipariş Kodu Order Code Best.-Nr.	Stok/Stock/Lager	Ürün Kodu Product Code Produkt-Code	Ölçüler (mm) Dimensions(mm) Abmessungen (mm)				Kullanılan Uç Insert WSP	Sıkma Cıvatası Clamp Screw Torx-Schraube	Anahtar Torx Key Torx-Schlüssel
			L	h	f	b			
D460	●	SVJCR 1212 J11-F	110	12	12	12	VCMT 1103	TC060 M2,5x5,5	T8
D462	●	SVJCR 1616 H11-F	100	16	16	16			

● Stokta/ In Stock / Lager ○ Sınırlı Stok / Limited Stock / Begrenzte Lagerhaltung

72,5° SVVCN

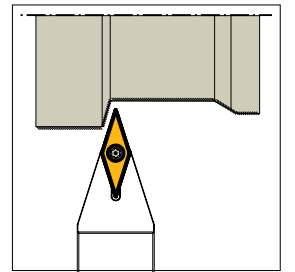
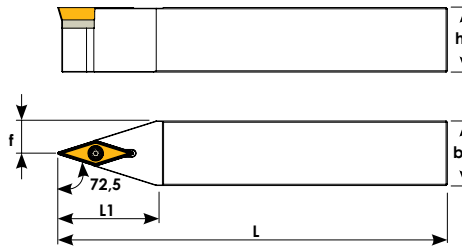

Sipariş Kodu Order Code Best.-Nr.	Stok/Stock/Lager	Ürün Kodu Product Code Produkt-Code	Ölçüler (mm) Dimensions(mm) Abmessungen (mm)					Kullanılan Uç Insert WSP	Sıkma Cıvatası Clamp Screw Torx-Schraube	Altlık Shim U-Platte	Altlık Cıvatası Shim Screw U-Platte Schraube	Anahtar Torx Key Torx-Schlüssel
			L	L1	H	f	b					
D142	●	SVVCN 1212 J11	110	22	12	6	12	VC-- 1103	TC060 M2,5x5,5	---	---	T8
D144	●	SVVCN 1616 H16	100	35	16	8	16	VCMT 1604	TC068 M3,5x11	TA034	TC048 M5	T15
D150	●	SVVCN 2020 K16	125	35	20	10	20					
D152	●	SVVCN 2525 M16	150	40	25	12.5	25					

30° SRGCR

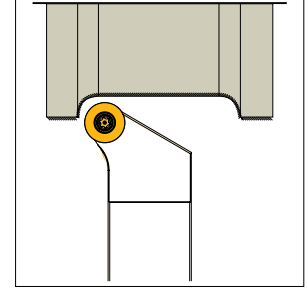
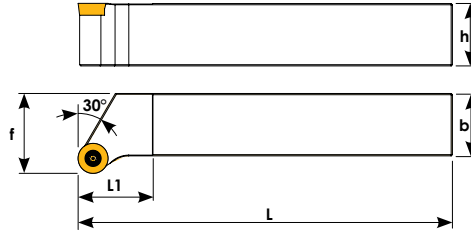

Sipariş Kodu Order Code Best.-Nr.	Stok/Stock/Lager	Ürün Kodu Product Code Produkt-Code	Ölçüler (mm) Dimensions (mm) Abmessungen (mm)					Kullanılan Uç Insert WSP	Sıkma Cıvatası Clamp Screw Torx-Schraube	Anahtar Torx Key Torx-Schlüssel
			L	L1	h	f	b			
D280	●	SRGCR 2020 K08	125	25	20	25	20	RCMT 0803	TC065 M3x7	T8
D282	●	SRGCR 2525 M08	150	30	25	32	25			
D284	●	SRGCR 2020 K10	125	25	20	25	20	RCMT 10T3	TC067 M3,5x9	T15
D286	●	SRGCR 2525 M10	150	30	25	32	25			
D288	●	SRGCR 2020 K12	125	25	20	25	20	RCMT 1204		
D290	●	SRGCR 2525 M12	150	30	25	32	25			

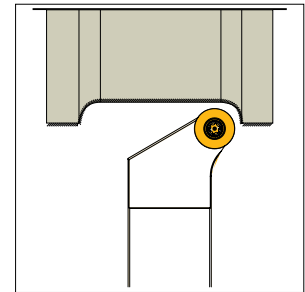
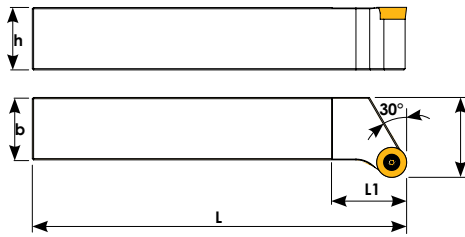

30° SRGCL

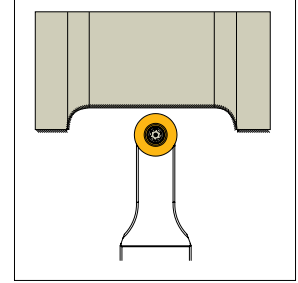
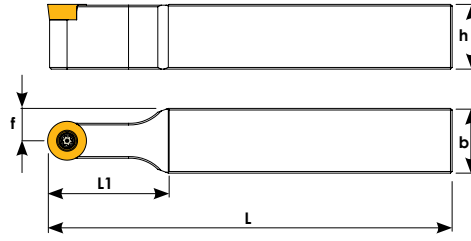

Sipariş Kodu Order Code Best.-Nr.	Stok/Stock/Lager	Ürün Kodu Product Code Produkt-Code	Ölçüler (mm) Dimensions (mm) Abmessungen (mm)					Kullanılan Uç Insert WSP	Sıkma Cıvatası Clamp Screw Torx-Schraube	Anahtar Torx Key Torx-Schlüssel
			L	L1	h	f	b			
D293	●	SRGCL 2020 K08	125	25	20	25	20	RCMT 0803	TC065 M3x7	T8
D294	●	SRGCL 2525 M08	150	30	25	32	25			
D283	●	SRGCL 2020 K10	125	25	20	25	20	RCMT 10T3	TC067 M3,5x9	T15
D292	●	SRGCL 2525 M10	150	30	25	32	25			
D281	●	SRGCL 2020 K12	125	25	20	25	20	RCMT 1204		
D291	●	SRGCL 2525 M12	150	30	25	32	25			

SRDCN

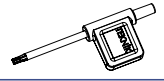

Sipariş Kodu Order Code Best.-Nr.	Stok/Stock/Lager	Ürün Kodu Product Code Produkt-Code	Ölçüler (mm) Dimensions (mm) Abmessungen (mm)					Kullanılan Uç Insert WSP	Baskı Civatası Locking Screw Verriegelungs Schraube	Anahtar Torx Key Torx-Schlüssel
			L	L1	h	f	b			
D270	●	SRDCN 2020 K08	125	37	20	10	20	RCMT 0803	TC065 M3x7	T8
D271	●	SRDCN 2525 M08	150	37	25	12.5	25			
D272	●	SRDCN 2020 K10	125	35	20	10	20	RCMT 1003	TC067 M3,5x9	T15
D274	●	SRDCN 2525 M10	150	35	25	12.5	25			
D276	●	SRDCN 2020 K12	125	38	20	10	20	RCMT 1204	TC067 M3,5x9	T15
D278	●	SRDCN 2525 M12	150	38	25	12.5	25			
D273	●	SRDCN 2525 M16	150	35	25	12.5	25	RCMT 1606	TC084 M5x13	T20

TIRTIL Kater Knurling Tool

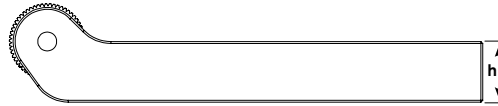

Sipariş Kodu Order Code Best.-Nr.	Stok/Stock/Lager	Ürün Kodu Product Code Produkt-Code	Ölçüler (mm) Dimensions (mm) Abmessungen (mm)		
			L	h	b
P100	●	16-20 CNC TIRTIL	125	16	20
P102	●	20-20 CNC TIRTIL	125	20	20
P104	●	25-25 CNC TIRTIL	150	25	25

95° SCLCR

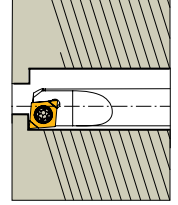
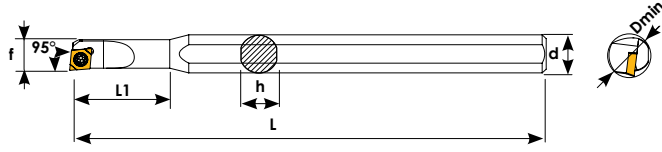

Sipariş Kodu Order Code Best.-Nr.	Stok/Stock/Lager	Ürün Kodu Product Code Produkt-Code	Ölçüler (mm) Dimensions (mm) Abmessungen (mm)						Kullanılan Uç Insert WSP	Sıkma Cıvatası Clamp Screw Torx-Schraube	Anahtar Torx Key Torx-Schlüssel
			Dmin	d	L	L1	f	h			
K097	●	S05-08H SCLCR 03	5	8	100	15	2,5	7	CC-- 0301	TC090 M1,6	T6
K098	●	S06-08H SCLCR 03	6	8	100	18	3	7			
K099	●	S07-08H SCLCR 04	7	8	100	21	3,5	7			

95° SCLCR

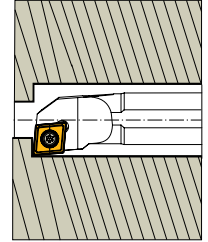
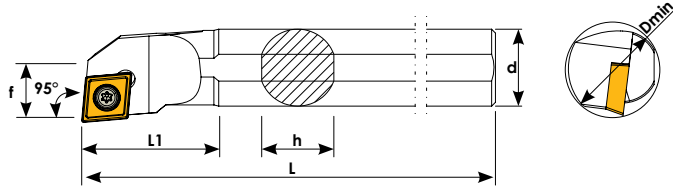

Sipariş Kodu Order Code Best.-Nr.	Stok/Stock/Lager	Ürün Kodu Product Code Produkt-Code	Ölçüler (mm) Dimensions (mm) Abmessungen (mm)						Kullanılan Uç Insert WSP	Sıkma Cıvatası Clamp Screw Torx-Schraube	Anahtar Torx Key Torx-Schlüssel
			Dmin	d	L	L1	f	h			
K100	●	S06-08H SCLCR 06	10	8	100	25	4,3	7	CC-- 0602	TC060 M2,5x5,5	T8
K102	●	S08H SCLCR 06	10	8	100	16	5,5	7			
K104	●	S10J SCLCR 06	12	10	110	20	6	9			
K105	●	S10K SCLCR 06	12	10	125	20	6	9			
K106	●	S12K SCLCR 06	16	12	125	25	9	11			
K107	●	S12Q SCLCR 06	16	12	180	25	9	11			
K10-1	●	S12K SCLCR 09	16	12	125	24	9	11			
K108	●	S14-16Q SCLCR 09	18	16	180	45	9,5	15	CC--09T3	TC067 M3,5x9	T15
K110	●	S16Q SCLCR 09	20	16	180	30	11	15			
K111	●	S16R SCLCR 09	20	16	200	30	11	15			
K112	●	S18-20Q SCLCR 09	21	20	180	38	11	18			
K114	●	S20Q SCLCR 09	25	20	180	40	11	18			
K115	●	S20S SCLCR 09	25	20	250	40	13	18			
K116	●	S25R SCLCR 09	32	25	200	40	17	23			
K117	●	S25T SCLCR 09	32	25	300	40	17	23			

95° SCLCL

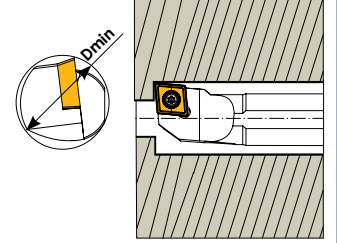
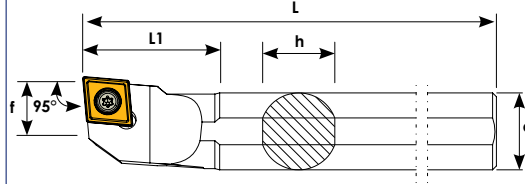

Sipariş Kodu Order Code Best.-Nr.	Stok/Stock/Lager	Ürün Kodu Product Code Produkt-Code	Ölçüler (mm) Dimensions(mm) Abmessungen (mm)						Kullanılan Uç Insert WSP	Sıkma Civatası Clamp Screw Torx-Schraube	Anahtar Torx Key Torx-Schlüssel
			Dmin	d	L	L1	f	h			
K230	●	S06-08H SCLCL 06	9	8	100	25	4.3	7	CC-- 0602	TC060 M2,5x5,5	T8
K232	●	S08H SCLCL 06	10	8	100	16	5.5	7			
K234	●	S10J SCLCL 06	12	10	110	20	6	9			
K236	●	S12K SCLCL 06	16	12	125	25	9	11			
K238	●	S14-16Q SCLCL 09	18	16	180	45	9,5	15	CC--09T3	TC067 M3,5x9	T15
K240	●	S16Q SCLCL 09	20	16	180	30	11	15			
K241	●	S16R SCLCL 09	20	16	200	30	11	15			
K244	●	S20Q SCLCL 09	25	20	180	40	13	18			
K245	●	S20S SCLCL 09	25	20	250	40	13	18			
K246	●	S25R SCLCL 09	32	25	200	40	17	23			

93° SDUCR

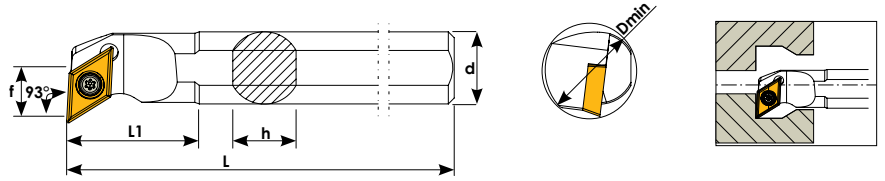

Sipariş Kodu Order Code Best.-Nr.	Stok/Stock/Lager	Ürün Kodu Product Code Produkt-Code	Ölçüler (mm) Dimensions (mm) Abmessungen (mm)						Kullanılan Uç Insert WSP	Sıkma Civatası Clamp Screw Torx-Schraube	Anahtar Torx Key Torx-Schlüssel
			Dmin	d	L	L1	f	h			
K120	●	S10J SDUCR 07	12	10	110	20	7	9	DC-- 0702	TC060 M2,5x5,5	T8
K122	●	S12K SDUCR 07	16	12	125	25	9	11			
K123	●	S12Q SDUCR 07	16	12	180	25	9	11			
K124	●	S14-16Q SDUCR 07	18	16	180	40	10.5	15			
K126	●	S16Q SDUCR 07	20	16	180	30	11	15	DC--11T3	TC067 M3,5x9	T15
K125	●	S14-16Q SDUCR 11	18	16	180	45	10,5	15			
K128	●	S16Q SDUCR 11	20	16	180	30	11	15			
K130	●	S20Q SDUCR 11	25	20	180	32	13	18			
K132	●	S25R SDUCR 11	32	25	200	40	17	23			
K134	●	S32T SDUCR 11	40	32	300	45	22	30			

93° SDUCL

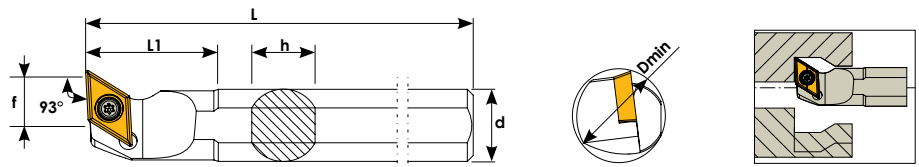

Sipariş Kodu Order Code Best.-Nr.	Stok/Stock/Lager	Ürün Kodu Product Code Produkt-Code	Ölçüler (mm) Dimensions (mm) Abmessungen (mm)						Kullanılan Uç Insert WSP	Sıkma Civatası Clamp Screw Torx-Schraube	Anahtar Torx Key Torx-Schlüssel
			Dmin	d	L	L1	f	h			
K250	●	S10J SDUCL 07	12	10	110	20	7	9	DC-- 0702	TC060 M2,5x5,5	T8
K252	●	S12K SDUCL 07	16	12	125	25	9	11			
K254	●	S14-16Q SDUCL 07	18	16	180	40	10.5	15			
K256	●	S16Q SDUCL 07	20	16	180	30	11	15			
K258	●	S16Q SDUCL 11	20	16	180	30	11	15	DC--11T3	TC067 M3,5x9	T15
K260	●	S20Q SDUCL 11	25	20	180	32	13	18			
K262	●	S25R SDUCL 11	32	25	200	40	17	23			
K263	●	S32T SDUCL 11	40	32	300	45	22	30			

107,5° SDQCR

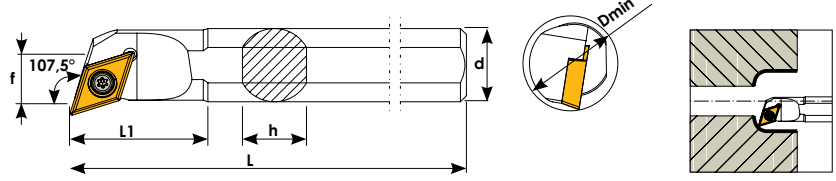

Sipariş Kodu Order Code Best.-Nr.	Stok/Stock/Lager	Ürün Kodu Product Code Produkt-Code	Ölçüler (mm) Dimensions (mm) Abmessungen (mm)						Kullanılan Uç Insert WSP	Sıkma Civatası Clamp Screw Torx-Schraube	Anahtar Torx Key Torx-Schlüssel
			Dmin	d	L	L1	f	h			
K140	●	S10J SDQCR 07	12	10	110	20	7	9	DC-- 0702	TC060 M2,5x5,5	T8
K142	●	S12K SDQCR 07	16	12	125	25	9	11			
K144	●	S16Q SDQCR 07	20	16	180	30	11	15			
K146	●	S16Q SDQCR 11	20	16	180	30	11	15	DC--11T3	TC067 M3,5x9	T15
K148	●	S20Q SDQCR 11	25	20	180	32	13	18			
K150	●	S25R SDQCR 11	32	25	200	40	17	23			
K152	●	S32T SDQCR 11	40	32	300	50	22	30			
K154	●	S40T SDQCR 11	50	40	300	50	27	38			

107,5° SDQCL

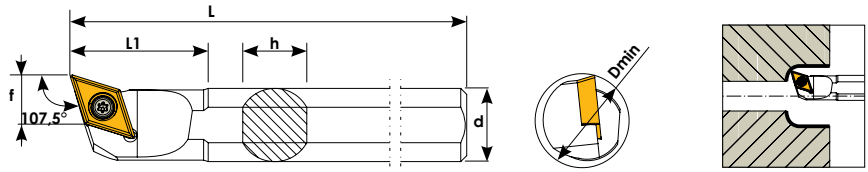

Sipariş Kodu Order Code Best.-Nr.	Stok/Stock/Lager	Ürün Kodu Product Code Produkt-Code	Ölçüler (mm) Dimensions (mm) Abmessungen (mm)						Kullanılan Uç Insert WSP	Sıkma Civatası Clamp Screw Torx-Schraube	Anahtar Torx Key Torx-Schlüssel
			Dmin	d	L	L1	f	h			
K270	●	S10J SDQCL 07	12	10	110	20	7	9	DC-- 0702	TC060 M2,5x5,5	T8
K272	●	S12K SDQCL 07	16	12	125	25	9	11			
K274	●	S16Q SDQCL 07	20	16	180	30	11	15			
K276	●	S16Q SDQCL 11	20	16	180	30	11	15	DC--11T3	TC067 M3,5x9	T15
K278	●	S20Q SDQCL 11	25	20	180	32	13	18			
K280	●	S25R SDQCL 11	32	25	200	40	17	23			
K281	●	S32T SDQCL 11	40	32	300	50	22	30			

120° SDXCR

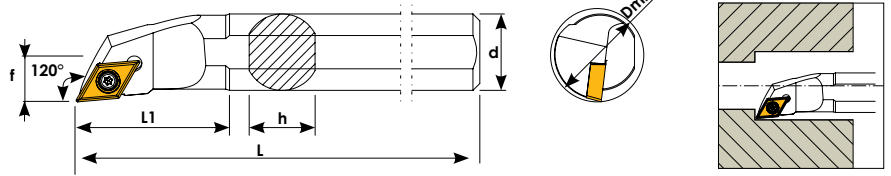

Sipariş Kodu Order Code Best.-Nr.	Stok/Stock/Lager	Ürün Kodu Product Code Produkt-Code	Ölçüler (mm) Dimensions (mm) Abmessungen (mm)						Kullanılan Uç Insert WSP	Sıkma Cıvatası Clamp Screw Torx-Schraube	Anahtar Torx Key Torx-Schlüssel
			Dmin	d	L	L1	f	h			
K469	●	S10J SDXCR 07	12	10	110	25	5.5	9	DC-- 0702	TC060 M2,5x5,5	T8
K470	●	S12K SDXCR 07	16	12	125	30	9	11			
K471	●	S16Q SDXCR 11	20	16	180	40	11	15	DC--11T3	TC067 M3,5x9	T15
K472	●	S20Q SDXCR 11	25	20	180	40	13	18			
K473	●	S25R SDXCR 11	32	25	200	50	13,5	23			
K474	●	S32T SDXCR 11	40	32	300	55	17	30			
K475	●	S40T SDXCR 11	50	40	300	55	21	38			

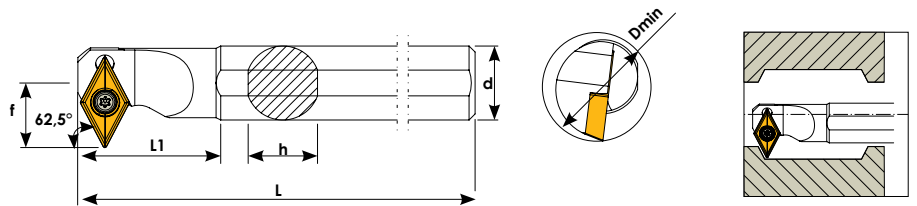

62,5° SD-CR



Sipariş Kodu Order Code Best.-Nr.	Stok/Stock/Lager	Ürün Kodu Product Code Produkt-Code	Ölçüler (mm) Dimensions (mm) Abmessungen (mm)						Kullanılan Uç Insert WSP	Sıkma Cıvatası Clamp Screw Torx-Schraube	Anahtar Torx Key Torx-Schlüssel
			Dmin	d	L	L1	f	h			
K168	●	S10J SD-CR 07	14	10	110	25	8.2	9	DC-- 0702	TC060 M2,5x5,5	T8
K170	●	S12K SD-CR 07	16	12	125	25	9	11			
K173	●	S16Q SD-CR 07	20	16	180	35	12	15	DC--11T3	TC067 M3,5x9	T15
K172	●	S16Q SD-CR 11	23	16	180	32	14	15			
K174	●	S20Q SD-CR 11	25	20	180	35	15	18			
K176	●	S25R SD-CR 11	32	25	200	45	17	23			
K178	●	S32T SD-CR 11	40	32	300	55	23	30			

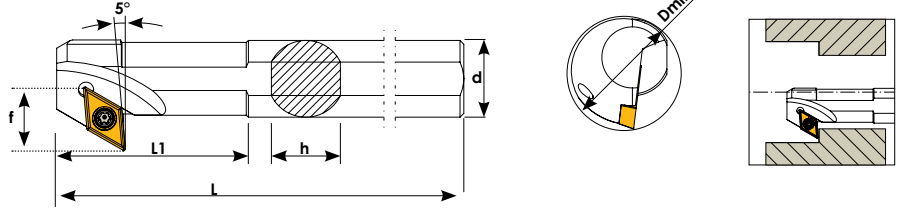
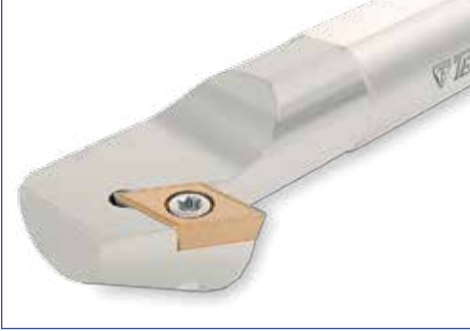

5° SDZCR

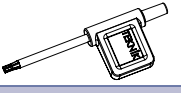

Sipariş Kodu Order Code Best.-Nr.	Stok/Stock/Lager	Ürün Kodu Product Code Produkt-Code	Ölçüler (mm) Dimensions(mm) Abmessungen (mm)						Kullanılan Uç Insert WSP	Sıkma Civatası Clamp Screw Torx-Schraube	Anahtar Torx Key Torx-Schlüssel
			Dmin	d	L	L1	f	h			
K190	●	S12K SDZCR 07	18	12	125	20	11	11	DC-- 0702	TC060 M2,5x5,5	T8
K192	●	S16Q SDZCR 11	23	16	180	25	14	15	DC--11T3	TC067 M3,5x9	T15
K194	●	S20Q SDZCR 11	30	20	180	32	19	18			
K196	●	S25R SDZCR 11	35	25	200	32	22	23			

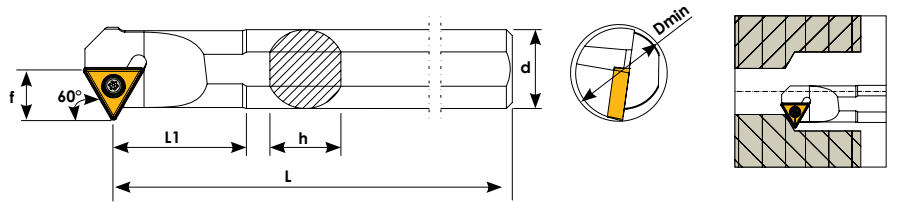

60° ST-CR

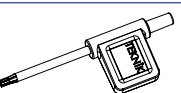

Sipariş Kodu Order Code Best.-Nr.	Stok/Stock/Lager	Ürün Kodu Product Code Produkt-Code	Ölçüler (mm) Dimensions(mm) Abmessungen (mm)						Kullanılan Uç Insert WSP	Sıkma Civatası Clamp Screw Torx-Schraube	Anahtar Torx Key Torx-Schlüssel
			Dmin	d	L	L1	f	h			
K180	●	S16Q ST-CR 16	20	16	180	40	11	15	TC--16T3	TC067 M3,5x9	T15
K182	●	S20Q ST-CR 16	25	20	180	40	13	18			
K183	●	S25R ST-CR 16	32	25	200	50	17	23			
K183-1	●	S32T ST-CR 16	30	32	300	60	22	30			

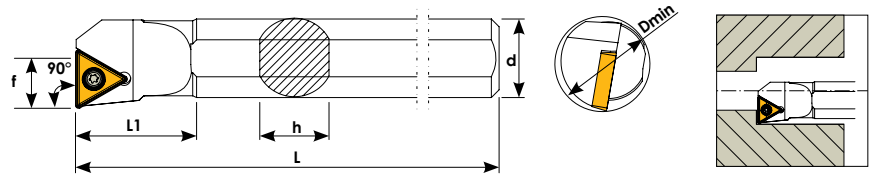

90° STFCR

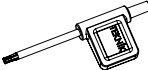

Sipariş Kodu Order Code Best.-Nr.	Stok/Stock/Lager	Ürün Kodu Product Code Produkt-Code	Ölçüler (mm) Dimensions(mm) Abmessungen (mm)						Kullanılan Uç Insert WSP	Sıkma Cıvatası Clamp Screw Torx-Schraube	Anahtar Torx Key Torx-Schlüssel
			Dmin	d	L	L1	f	h			
K160	●	S12K STFCR 11	16	12	125	25	9	11	TCMT 1102	TC060 M2,5x5,5	T8
K161	●	S16Q STFCR 11	20	16	180	30	11	15			
K162	●	S16Q STFCR 16	20	16	180	30	11	15	TCMT 16T3	TC067 M3,5x9	T15
K164	●	S20Q STFCR 16	25	20	180	32	13	18			
K166	●	S25R STFCR 16	32	25	200	40	16	23			

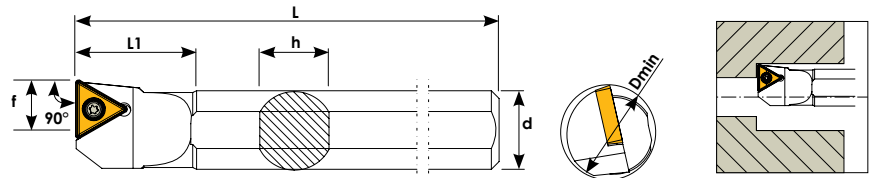
90° STFCL

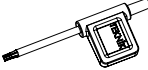

Sipariş Kodu Order Code Best.-Nr.	Stok/Stock/Lager	Ürün Kodu Product Code Produkt-Code	Ölçüler (mm) Dimensions(mm) Abmessungen (mm)						Kullanılan Uç Insert WSP	Sıkma Cıvatası Clamp Screw Torx-Schraube	Anahtar Torx Key Torx-Schlüssel
			Dmin	d	L	L1	f	h			
K184	●	S12K STFCL 11	16	12	125	25	9	11	TCMT 1102	TC060 M2,5x5,5	T8
K185	●	S16Q STFCL 11	20	16	180	30	11	15			
K186	●	S16Q STFCL 16	20	16	180	30	11	15	TCMT 16T3	TC067 M3,5x9	T15
K187	●	S20Q STFCL 16	25	20	180	32	13	18			
K188	●	S25R STFCL 16	32	25	200	40	16	23			

93° SVUCR

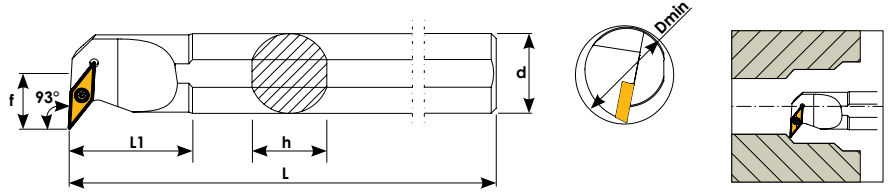
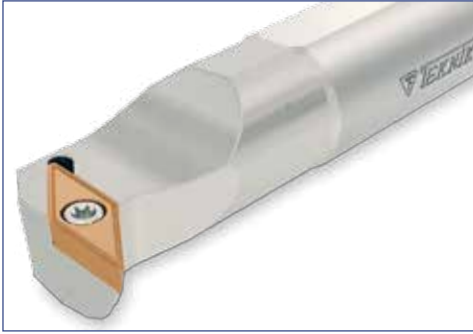

Sipariş Kodu Order Code Best.-Nr.	Stok/Stock/Lager	Ürün Kodu Product Code Produkt-Code	Ölçüler (mm) Dimensions(mm) Abmessungen (mm)						Kullanılan Uç Insert WSP	Sıkma Cıvatası Clamp Screw Torx-Schraube	Anahtar Torx Key Torx-Schlüssel
			Dmin	d	L	L1	f	h			
K211	●	S16Q SVUCR 11	20	16	180	30	11	15	VCMT 1103	TC060 M2,5x5,5	T8
K212	●	S20Q SVUCR 11	25	20	180	32	13	18			
K213	●	S25R SVUCR 16	32	25	200	40	17	23	VCMT 1604	TC074 M4x10	T15
K214	●	S32T SVUCR 16	40	32	300	50	22	30			
K215	○	S40T SVUCR 16	50	40	300	55	27	38			

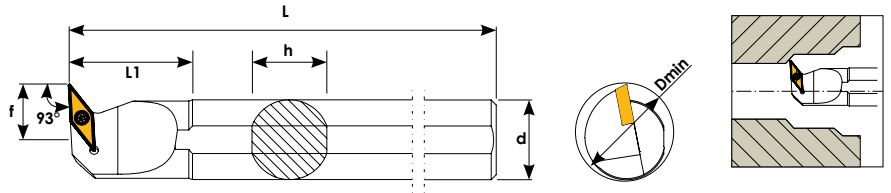
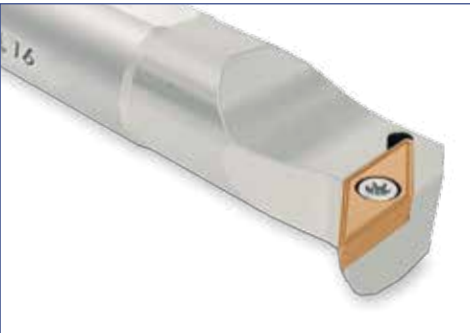

93° SVUCL

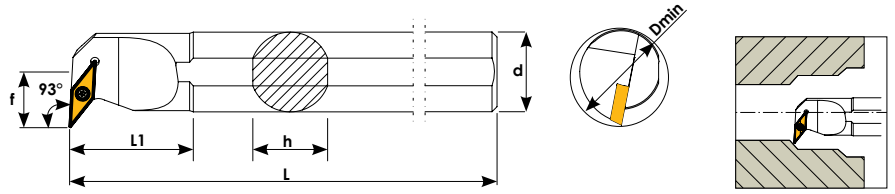
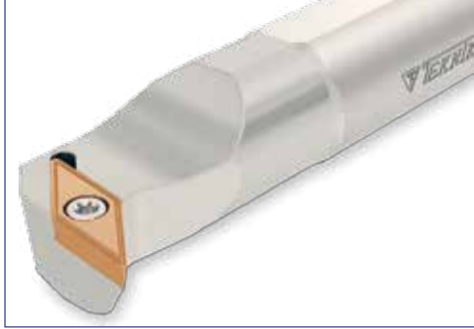

Sipariş Kodu Order Code Best.-Nr.	Stok/Stock/Lager	Ürün Kodu Product Code Produkt-Code	Ölçüler (mm) Dimensions(mm) Abmessungen (mm)						Kullanılan Uç Insert WSP	Sıkma Cıvatası Clamp Screw Torx-Schraube	Anahtar Torx Key Torx-Schlüssel
			Dmin	d	L	L1	f	h			
K300	●	S16Q SVUCL 11	20	16	180	30	11	15	VCMT 1103	TC060 M2,5x5,5	T8
K302	●	S20Q SVUCL 11	25	20	180	32	13	18			
K304	●	S25R SVUCL 16	32	25	200	40	17	23	VCMT 1604	TC074 M4x10	T15
K306	●	S32T SVUCL 16	40	32	300	50	22	30			

93° SVUBR



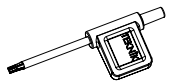

Sipariş Kodu Order Code Best.-Nr.	Stok/Stock/Lager	Ürün Kodu Product Code Produkt-Code	Ölçüler (mm) Dimensions (mm) Abmessungen (mm)						Kullanılan Uç Insert WSP	Sıkma Cıvatası Clamp Screw Torx-Schraube	Anahtar Torx Key Torx-Schlüssel
			Dmin	d	L	L1	f	h			
K206	●	S16Q SVUBR 11	20	16	180	30	11	15	VBMT 1103	TC060 M2,5x5,5	T8
K207	●	S20Q SVUBR 11	25	20	180	32	13	18			
K208	●	S25R SVUBR 16	32	25	200	40	17	23	VBMT 1604	TC074 M4x10	T15
K209	●	S32T SVUBR 16	40	32	300	50	22	30			
K210	●	S40T SVUBR 16	50	40	300	50	27	38			

● Stokta / In Stock / Lager ○ Sınırlı Stok / Limited Stock / Begrenzte Lagerhaltung

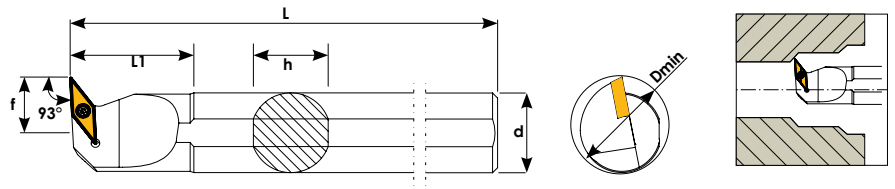

93° SVUBL

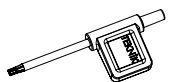

Sipariş Kodu Order Code Best.-Nr.	Stok/Stock/Lager	Ürün Kodu Product Code Produkt-Code	Ölçüler (mm) Dimensions (mm) Abmessungen (mm)						Kullanılan Uç Insert WSP	Sıkma Cıvatası Clamp Screw Torx-Schraube	Anahtar Torx Key Torx-Schlüssel
			Dmin	d	L	L1	f	h			
K282	●	S16Q SVUBL 11	20	16	180	30	11	15	VBMT 1103	TC060 M2,5x5,5	T8
K284	●	S20Q SVUBL 11	25	20	180	32	13	18			
K286	●	S25R SVUBL 16	32	25	200	40	17	23	VBMT 1604	TC074 M4x10	T15
K288	●	S32T SVUBL 16	40	32	300	50	22	30			

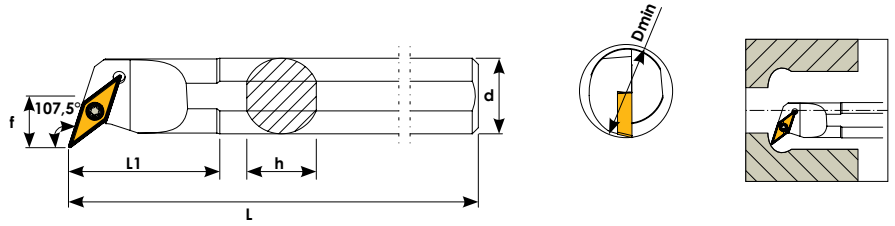

107,5° SVQBR

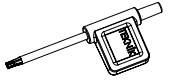

Sipariş Kodu Order Code Best.-Nr.	Stok/Stock/Lager	Ürün Kodu Product Code Produkt-Code	Ölçüler (mm) Dimensions(mm) Abmessungen (mm)						Kullanılan Uç Insert WSP	Sıkma Civatası Clamp Screw Torx-Schraube	Anahtar Torx Key Torx-Schlüssel
			Dmin	d	L	L1	f	h			
K216	●	S16Q SVQBR 11	20	16	180	30	11	15	VBMT 1103	TC060 M2,5x5,5	T8
K217	●	S20Q SVQBR 11	25	20	180	30	13	18			
K218	●	S25R SVQBR 16	32	25	200	50	17	23	VBMT 1604	TC074 M4x10	T15
K219	●	S32T SVQBR 16	40	32	300	50	22	30			
K220	●	S40T SVQBR 16	50	40	300	55	27	38			

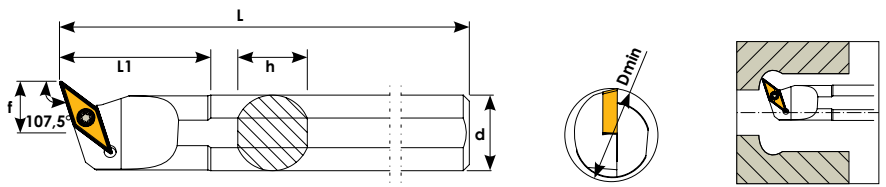
107,5° SVQBL

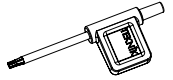

Sipariş Kodu Order Code Best.-Nr.	Stok/Stock/Lager	Ürün Kodu Product Code Produkt-Code	Ölçüler (mm) Dimensions(mm) Abmessungen (mm)						Kullanılan Uç Insert WSP	Sıkma Civatası Clamp Screw Torx-Schraube	Anahtar Torx Key Torx-Schlüssel
			Dmin	d	L	L1	f	h			
K310	●	S16Q SVQBL 11	20	16	180	30	11	15	VBMT 1103	TC060 M2,5x5,5	T8
K312	●	S20Q SVQBL 11	25	20	180	30	13	18			
K314	●	S25R SVQBL 16	32	25	200	50	17	23	VBMT 1604	TC074 M4x10	T15
K316	●	S32T SVQBL 16	40	32	300	50	22	30			
K318	●	S40T SVQBL 16	50	40	300	55	27	38			

107,5° SVQCR

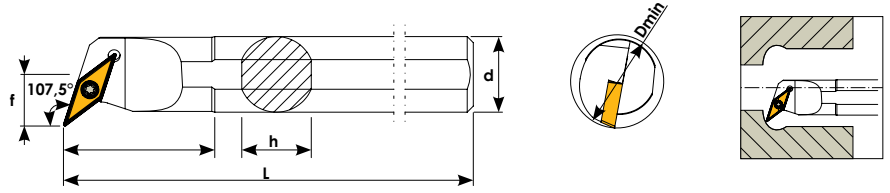

Sipariş Kodu Order Code Best.-Nr.	Stok/Stock/Lager	Ürün Kodu Product Code Produkt-Code	Ölçüler (mm) Dimensions (mm) Abmessungen (mm)						Kullanılan Uç Insert WSP	Sıkma Civatası Clamp Screw Torx-Schraube	Anahtar Torx Key Torx-Schlüssel
			Dmin	d	L	L1	f	h			
K221	●	S16Q SVQCR 11	20	16	180	30	11	15	VCMT 1103	TC060 M2,5x5,5	T8
K222	●	S20Q SVQCR 11	25	20	180	30	13	18			
K223	●	S25R SVQCR 16	32	25	200	50	17	23	VCMT 1604	TC074 M4x10	T15
K224	●	S32T SVQCR 16	40	32	300	50	22	30			
K225	●	S40T SVQCR 16	50	40	300	55	27	38			

107,5° SVQCL

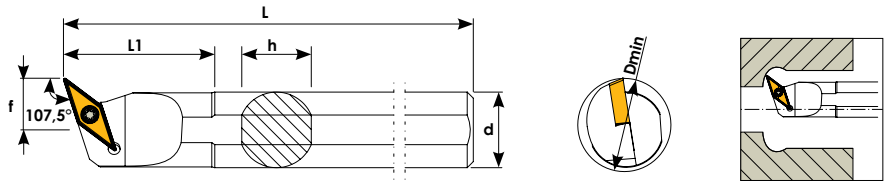

Sipariş Kodu Order Code Best.-Nr.	Stok/Stock/Lager	Ürün Kodu Product Code Produkt-Code	Ölçüler (mm) Dimensions (mm) Abmessungen (mm)						Kullanılan Uç Insert WSP	Sıkma Civatası Clamp Screw Torx-Schraube	Anahtar Torx Key Torx-Schlüssel
			Dmin	d	L	L1	f	h			
K319	●	S16Q SVQCL 11	20	16	180	30	11	15	VCMT 1103	TC060 M2,5x5,5	T8
K320	●	S20Q SVQCL 11	25	20	180	30	13	18			
K322	●	S25R SVQCL 16	32	25	200	50	17	23	VCMT 1604	TC074 M4x10	T15
K324	●	S32T SVQCL 16	40	32	300	50	22	30			



**İç Çap Kater İçten
Soğutmalı**

Boring Bars (Coolant)
Bohrstange
(Mit Innenkühlung)

95° SCLCR IK

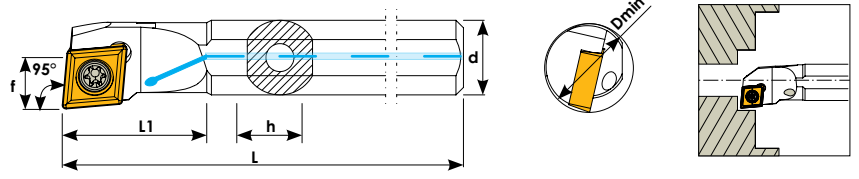

Sipariş Kodu Order Code Best.-Nr.	Stok/Stock/Lager	Ürün Kodu Product Code	Ölçüler (mm) Dimensions(mm) Abmessungen (mm)						Kullanılan Uç Insert WSP	Sıkma Cıvatası Clamp Screw Torx-Schraube	Anahtar Torx Key Torx-Schlüssel
			Dmin	d	L	L1	f	h			
KA102	●	A08H SCLCR 06	10	8	100	16	5,5	7	CC-- 0602	TC060 M2,5x5,5	T8
KA104	●	A10J SCLCR 06	12	10	110	20	6	9			
KA106	●	A12K SCLCR 06	16	12	125	25	9	11			
KA108	●	A14-16Q SCLCR 09	18	16	180	45	9,5	15	CC-- 09T3	TC067 M3,5x9	T15
KA110	●	A16Q SCLCR 09	20	16	180	30	11	15			
KA111	●	A16M SCLCR 09	20	16	150	30	11	15			
KA114	●	A20Q SCLCR 09	25	20	180	40	13	18			
KA116	●	A25R SCLCR 09	32	25	200	40	17	23			

95° SCLCL IK

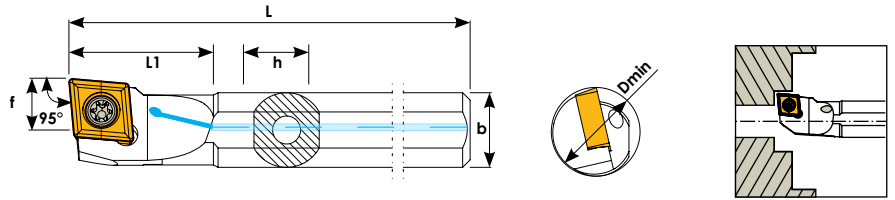

Sipariş Kodu Order Code Best.-Nr.	Stok/Stock/Lager	Ürün Kodu Product Code Produkt-Code	Ölçüler (mm) Dimensions(mm) Abmessungen (mm)						Kullanılan Uç Insert WSP	Sıkma Cıvatası Clamp Screw Torx-Schraube	Anahtar Torx Key Torx-Schlüssel
			Dmin	d	L	L1	f	h			
KA232	●	A08H SCLCL 06	10	8	100	16	5,5	7	CC-- 0602	TC060 M2,5x5,5	T8
KA234	●	A10J SCLCL 06	12	10	110	20	6	9			
KA236	●	A12K SCLCL 06	16	12	125	25	9	11			
KA239	●	A16M SCLCL 09	20	16	150	30	11	15	CC-- 09T3	TC067 M3,5x9	T15
KA240	●	A16Q SCLCL 09	20	16	180	30	11	15			
KA244	●	A20Q SCLCL 09	25	20	180	40	13	18			
KA246	●	A25R SCLCL 09	32	25	200	40	17	23			

90° STFCR IK

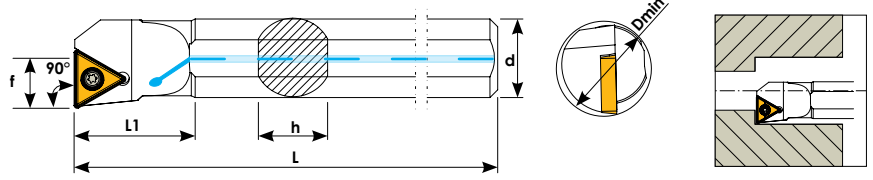

Sipariş Kodu Order Code Best.-Nr.	Stok/Stock/Lager	Ürün Kodu Product Code Produkt-Code	Ölçüler (mm) Dimensions(mm) Abmessungen (mm)						Kullanılan Uç Insert WSP	Sıkma Civatası Clamp Screw Torx-Schraube	Anahtar Torx Key Torx-Schlüssel
			Dmin	d	L	L1	f	h			
KA160	●	A12K STFCR 11	16	12	125	25	9	11	TCMT 1102	TC060 M2,5x5,5	T8
KA161	●	A16Q STFCR 11	20	16	180	30	11	15			
KA162	●	A16Q STFCR 16	20	16	180	30	11	15	TCMT 16T3	TC067 M3,5x9	T15
KA164	●	A20Q STFCR 16	25	20	180	32	13	18			
KA166	●	A25R STFCR 16	32	25	200	40	16	23			

90° STFCL IK

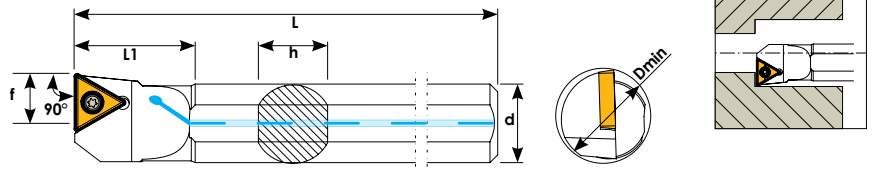

Sipariş Kodu Order Code Best.-Nr.	Stok/Stock/Lager	Ürün Kodu Product Code Produkt-Code	Ölçüler (mm) Dimensions(mm) Abmessungen (mm)						Kullanılan Uç Insert WSP	Sıkma Civatası Clamp Screw Torx-Schraube	Anahtar Torx Key Torx-Schlüssel
			Dmin	d	L	L1	f	h			
KA184	●	A12K STFCL 11	16	12	125	25	9	11	TCMT 1102	TC060 M2,5x5,5	T8
KA185	●	A16Q STFCL 11	20	16	180	30	11	15			
KA186	●	A16Q STFCL 16	20	16	180	30	11	15	TCMT 16T3	TC067 M3,5x9	T15
KA187	●	A20Q STFCL 16	25	20	180	32	13	18			
KA188	●	A25R STFCL 16	32	25	200	40	16	23			

93° SDUCR IK

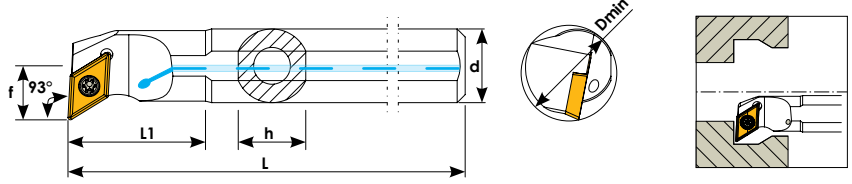

Sipariş Kodu Order Code Best.-Nr.	Stok/Stock/Lager	Ürün Kodu Product Code Produkt-Code	Ölçüler (mm) Dimensions(mm) Abmessungen (mm)						Kullanılan Uç Insert WSP	Sıkma Cıvatası Clamp Screw Torx-Schraube	Anahtar Torx Key Torx-Schlüssel
			Dmin	d	L	L1	f	h			
KA120	●	A10J SDUCR 07	12	10	110	20	7	9	DC--0702	TC060 M2,5x5,5	T8
KA122	●	A12K SDUCR 07	16	12	125	25	9	11			
KA124	●	A14-16Q SDUCR 07	18	16	180	40	10,5	15			
KA126	●	A16Q SDUCR 07	20	16	180	30	11	15			
KA127	●	A16M SDUCR 07	20	16	150	30	11	15			
KA128	●	A16Q SDUCR 11	20	16	180	30	11	15			
KA129	●	A16M SDUCR 11	20	16	150	30	11	15	DC--11T3	TC067 M3,5x9	T15
KA130	●	A20Q SDUCR 11	25	20	180	32	13	18			
KA132	●	A25R SDUCR 11	32	25	200	40	17	23			
KA134	●	A32T SDUCR 11	40	32	300	45	22	30			

93° SDUCL IK

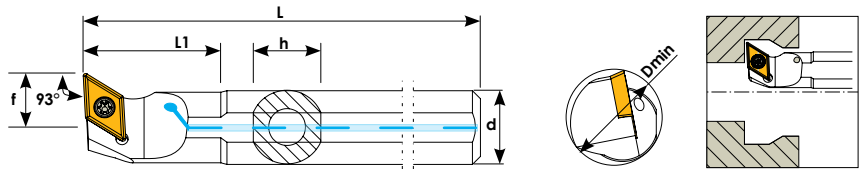

Sipariş Kodu Order Code Best.-Nr.	Stok/Stock/Lager	Ürün Kodu Product Code Produkt-Code	Ölçüler (mm) Dimensions(mm) Abmessungen (mm)						Kullanılan Uç Insert WSP	Sıkma Cıvatası Clamp Screw Torx-Schraube	Anahtar Torx Key Torx-Schlüssel
			Dmin	d	L	L1	f	h			
KA250	●	A10J SDUCL 07	12	10	110	20	7	9	DC--0702	TC060 M2,5x5,5	T8
KA252	●	A12K SDUCL 07	16	12	125	25	9	11			
KA254	●	A14-16Q SDUCL 07	18	16	180	40	10,5	15			
KA256	●	A16Q SDUCL 07	20	16	180	30	11	15			
KA258	●	A16Q SDUCL 11	20	16	180	30	11	15			
KA259	●	A16M SDUCL 11	20	16	150	30	11	15			
KA260	●	A20Q SDUCL 11	25	20	180	32	13	18	DC--11T3	TC067 M3,5x9	T15
KA262	●	A25R SDUCL 11	32	25	200	40	17	23			
KA263	●	S32T SDUCL 11	40	32	300	45	22	30			

107,5° SDQCR IK

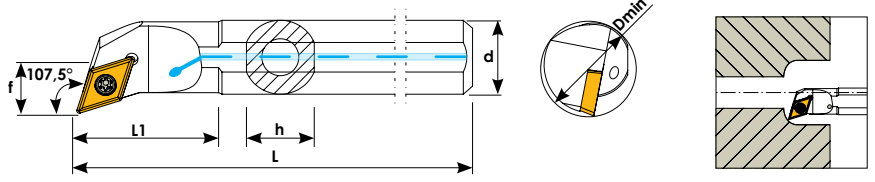

Sipariş Kodu Order Code Best.-Nr.	Stok/Stock/Lager	Ürün Kodu Product Code Produkt-Code	Ölçüler (mm) Dimensions (mm) Abmessungen (mm)						Kullanılan Uç Insert WSP	Sıkma Civatası Clamp Screw Torx-Schraube	Anahtar Torx Key Torx-Schlüssel
			Dmin	d	L	L1	f	h			
KA140	●	A10J SDQCR 07	12	10	110	20	7	9	DC--0702	TC060 M2,5x5,5	T8
KA142	●	A12K SDQCR 07	16	12	125	25	9	11			
KA143	●	A16M SDQCR 07	20	16	150	30	11	15			
KA144	●	A16Q SDQCR 07	20	16	180	30	11	15			
KA146	●	A16Q SDQCR 11	20	16	180	30	11	15	DC--11T3	TC067 M3,5x9	T15
KA148	●	A20Q SDQCR 11	25	20	180	32	13	18			
KA150	●	A25R SDQCR 11	32	25	200	40	17	23			

107,5° SDQCL IK

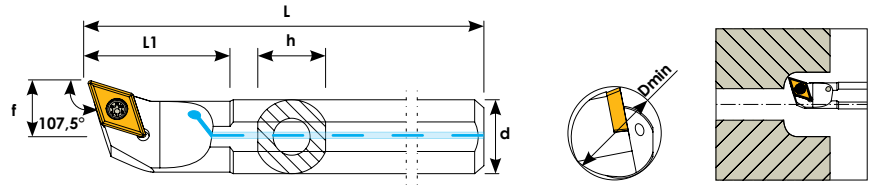

Sipariş Kodu Order Code Best.-Nr.	Stok/Stock/Lager	Ürün Kodu Product Code Produkt-Code	Ölçüler (mm) Dimensions (mm) Abmessungen (mm)						Kullanılan Uç Insert WSP	Sıkma Civatası Clamp Screw Torx-Schraube	Anahtar Torx Key Torx-Schlüssel
			Dmin	d	L	L1	f	h			
KA270	●	A10J SDQCL 07	12	10	110	20	7	9	DC--0702	TC060 M2,5x5,5	T8
KA272	●	A12K SDQCL 07	16	12	125	25	9	11			
KA273	●	A16M SDQCL 07	20	16	150	30	11	15			
KA274	●	A16Q SDQCL 07	20	16	180	30	11	15			
KA276	●	A16Q SDQCL 11	20	16	180	30	11	15	DC--11T3	TC067 M3,5x9	T15
KA278	●	A20Q SDQCL 11	25	20	180	32	13	18			
KA280	●	A25R SDQCL 11	32	25	200	40	17	23			

93° SVUCR IK

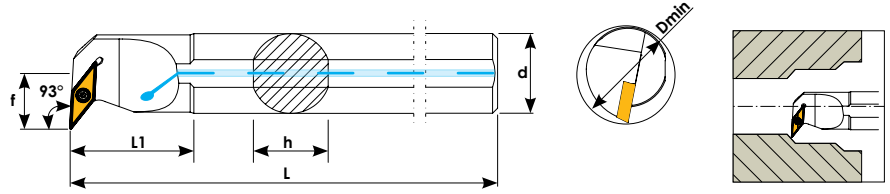

Sipariş Kodu Order Code Best.-Nr.	Stok/Stock/Lager	Ürün Kodu Product Code Produkt-Code	Ölçüler (mm) Dimensions (mm) Abmessungen (mm)						Kullanılan Uç Insert WSP	Sıkma Cıvatası Clamp Screw Torx-Schraube	Anahtar Torx Key Torx-Schlüssel
			Dmin	d	L	L1	f	h			
KA211	●	A16Q SVUCR 11	20	16	180	30	11	15	VCMT 1103	TC060 M2,5x5,5	T8
KA212	●	A20Q SVUCR 11	25	20	180	32	13	18			
KA213	●	A25R SVUCR 16	32	25	200	40	17	23	VCMT 1604	TC074 M4x10	T15
KA214	●	A32T SVUCR 16	40	32	300	50	22	30			

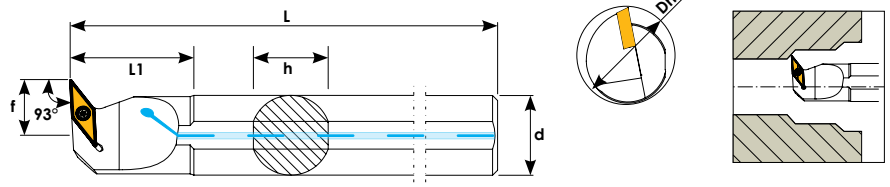

93° SVUCL IK



Sipariş Kodu Order Code Best.-Nr.	Stok/Stock/Lager	Ürün Kodu Product Code Produkt-Code	Ölçüler (mm) Dimensions (mm) Abmessungen (mm)						Kullanılan Uç Insert WSP	Sıkma Cıvatası Clamp Screw Torx-Schraube	Anahtar Torx Key Torx-Schlüssel
			Dmin	d	L	L1	f	h			
KA300	●	A16Q SVUCL 11	20	16	180	30	11	15	VCMT 1103	TC060 M2,5x5,5	T8
KA302	●	A20Q SVUCL 11	25	20	180	32	13	18			
KA304	●	A25R SVUCL 16	32	25	200	40	17	23	VCMT 1604	TC074 M4x10	T15
KA306	●	A32T SVUCL 16	40	32	300	50	22	30			

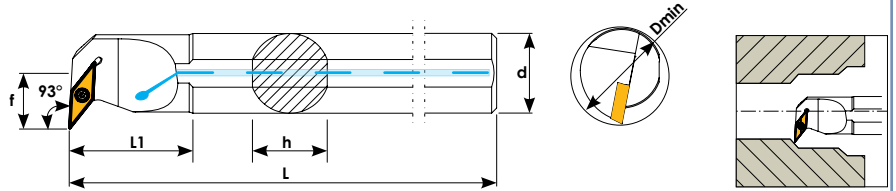

93° SVUBR IK

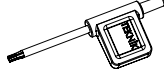

Sipariş Kodu Order Code Best.-Nr.	Stok/Stock/Lager	Ürün Kodu Product Code Produkt-Code	Ölçüler (mm) Dimensions(mm) Abmessungen (mm)						Kullanılan Uç Insert WSP	Sıkma Civatası Clamp Screw Torx-Schraube	Anahtar Torx Key Torx-Schlüssel
			Dmin	d	L	L1	f	h			
KA208	●	A25R SVUBR 16	32	25	200	40	17	23	VBMT 1604	TC074 M4x10	T15
KA209	●	A32T SVUBR 16	40	32	300	50	22	30			

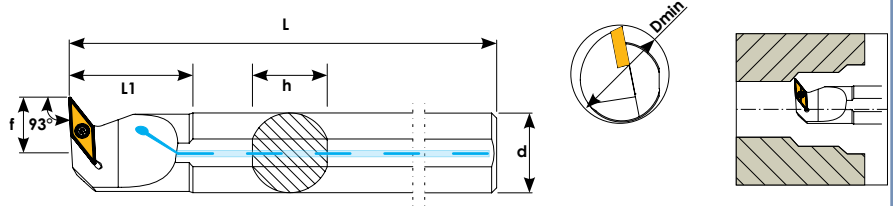
93° SVUBL IK

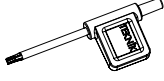

Sipariş Kodu Order Code Best.-Nr.	Stok/Stock/Lager	Ürün Kodu Product Code Produkt-Code	Ölçüler (mm) Dimensions(mm) Abmessungen (mm)						Kullanılan Uç Insert WSP	Sıkma Civatası Clamp Screw Torx-Schraube	Anahtar Torx Key Torx-Schlüssel
			Dmin	d	L	L1	f	h			
KA286	●	A25R SVUBL 16	32	25	200	40	17	23	VBMT 1604	TC074 M4x10	T15
KA288	●	A32T SVUBL 16	40	32	300	50	22	30			

107,5° SVQCR IK

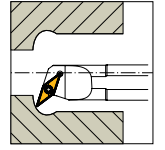
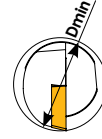
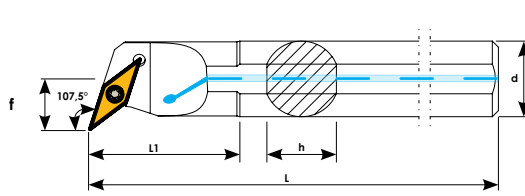

Sipariş Kodu Order Code Best.-Nr.	Stok/Stock/Lager	Ürün Kodu Product Code Produkt-Code	Ölçüler (mm) Dimensions (mm) Abmessungen (mm)						Kullanılan Uç Insert WSP	Sıkma Cıvatası Clamp Screw Torx-Schraube	Anahtar Torx Key Torx-Schlüssel
			Dmin	d	L	L1	f	h			
KA221	●	A16Q SVQCR 11	20	16	180	30	11	15	VBMT 1103	TC060 M2,5x5,5	T8
KA222	●	A20Q SVQCR 11	25	20	180	30	13	18			



**NEW
PRODUCT**





Karbür İç Çap Kater / Set
Carbide Boring Bars / Set
VHM Bohrstange / Set

www.teknikcuttingtools.com







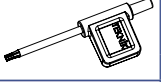

E-SCLCR SET

Sipariş Kodu Order Code Best.-Nr.	Setteki Ürün Kodları Product Code In Set Produkt-Code in Set	Ölçüler (mm) Dimensions(mm) Abmessungen (mm)						Kullanılan Uç Insert WSP	Sıkma Civatası Clamp Screw Torx-Schraube	Anahtar Torx Key Torx-Schlüssel
		Dmin	d	L	f	h				
İPS30	E08K SCLCR 06	10	8	125	5	7,5				
	E10K SCLCR 06	12	10	125	6	9,5				
	E12M SCLCR 06	16	12	150	7	11,5				

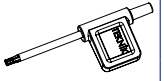

E-SCLCL SET

Sipariş Kodu Order Code Best.-Nr.	Setteki Ürün Kodları Product Code In Set Produkt-Code in Set	Ölçüler (mm) Dimensions(mm) Abmessungen (mm)						Kullanılan Uç Insert WSP	Sıkma Civatası Clamp Screw Torx-Schraube	Anahtar Torx Key Torx-Schlüssel
		Dmin	d	L	f	h				
İPS31	E08K SCLCL 06	10	8	125	5	7,5				
	E10K SCLCL 06	12	10	125	6	9,5				
	E12M SCLCL 06	16	12	150	7	11,5				

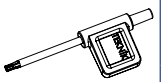

E-SDUCR SET

Sipariş Kodu Order Code Best.-Nr.	Setteki Ürün Kodları Product Code In Set Produkt-Code in Set	Ölçüler (mm) Dimensions(mm) Abmessungen (mm)						Kullanılan Uç Insert WSP	Sıkma Civatası Clamp Screw Torx-Schraube	Anahtar Torx Key Torx-Schlüssel
		Dmin	d	L	f	h				
İPS32	E10K SDUCR 07	13	10	125	7	9,5				
	E12M SDUCR 07	16	12	150	9	11,5				

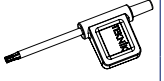

E-SDUCL SET

Sipariş Kodu Order Code Best.-Nr.	Setteki Ürün Kodları Product Code In Set Produkt-Code in Set	Ölçüler (mm) Dimensions(mm) Abmessungen (mm)						Kullanılan Uç Insert WSP	Sıkma Civatası Clamp Screw Torx-Schraube	Anahtar Torx Key Torx-Schlüssel
		Dmin	d	L	f	h				
İPS33	E10K SDUCL 07	13	10	125	7	9,5				
	E12M SDUCL 07	16	12	150	9	11,5				

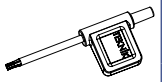
E-SDQCR SET

Sipariş Kodu Order Code Best.-Nr.	Setteki Ürün Kodları Product Code In Set Produkt-Code in Set	Ölçüler (mm) Dimensions(mm) Abmessungen (mm)						Kullanılan Uç Insert WSP	Sıkma Civatası Clamp Screw Torx-Schraube	Anahtar Torx Key Torx-Schlüssel
		Dmin	d	L	f	h				
İPS34	E10K SDQCR 07	13	10	125	7	9,5				
	E12M SDQCR 07	16	12	150	9	11,5				

E-SDQCL SET

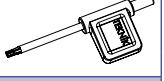
Sipariş Kodu Order Code Best.-Nr.	Setteki Ürün Kodları Product Code In Set Produkt-Code in Set	Ölçüler (mm) Dimensions(mm) Abmessungen (mm)						Kullanılan Uç Insert WSP	Sıkma Civatası Clamp Screw Torx-Schraube	Anahtar Torx Key Torx-Schlüssel
		Dmin	d	L	f	h				
İPS35	E10K SDQCL 07	13	10	125	7	9,5				
	E12M SDQCL 07	16	12	150	9	11,5				

**NEW
PRODUCT**

95° E-SCLCR IK

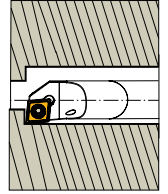
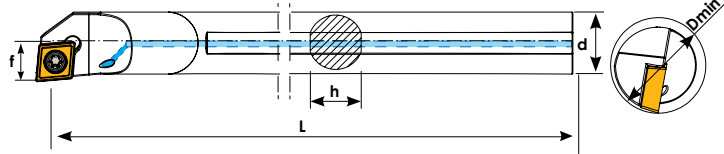

Sipariş Kodu Order Code Best.-Nr.	Stok/Stock/Lager	Ürün Kodu Product Code Produkt-Code	Ölçüler (mm) Dimensions(mm) Abmessungen (mm)					Kullanılan Uç Insert WSP	Sıkma Civatası Clamp Screw Torx-Schraube	Anahtar Torx Key Torx-Schlüssel
			Dmin	d	L	f	h			
KE10	●	E08K SCLCR 06	10	8	125	5	7,5	CC-- 0602	TC060 M2,5x5,5	T8
KE11	●	E10K SCLCR 06	12	10	125	6	9,5			
KE12	●	E12M SCLCR 06	16	12	150	7	11,5			
KE13	●	E16R SCLCR 09	20	16	200	10	15,5	CCMT 09T3	TC067 M3,5x9	T15
KE14	●	E20S SCLCR 09	25	20	250	13	19,5			

95° E-SCLCL IK

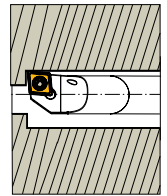
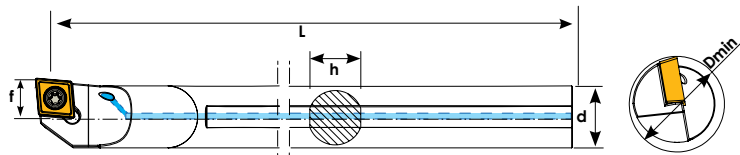



Sipariş Kodu Order Code Best.-Nr.	Stok/Stock/Lager	Ürün Kodu Product Code Produkt-Code	Ölçüler (mm) Dimensions(mm) Abmessungen (mm)					Kullanılan Uç Insert WSP	Sıkma Civatası Clamp Screw Torx-Schraube	Anahtar Torx Key Torx-Schlüssel
			Dmin	d	L	f	h			
KE17	●	E08K SCLCL 06	10	8	125	5	7,5	CC-- 0602	TC060 M2,5x5,5	T8
KE18	●	E10K SCLCL 06	12	10	125	6	9,5			
KE19	●	E12M SCLCL 06	16	12	150	7	11,5			
KE20	●	E16R SCLCL 09	20	16	200	10	15,5	CCMT 09T3	TC067 M3,5x9	T15
KE21	●	E20S SCLCL 09	25	20	250	13	19,5			



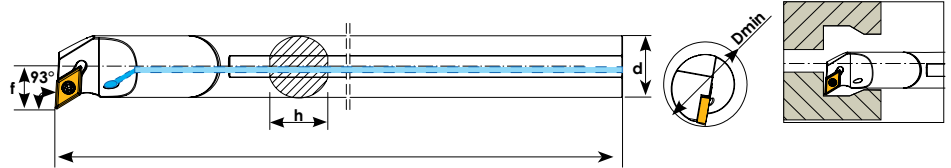

93° E-SDUCR IK

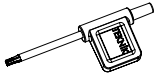

Sipariş Kodu Order Code Best.-Nr.	Stok/Stock/Lager	Ürün Kodu Product Code Produkt-Code	Ölçüler (mm) Dimensions(mm) Abmessungen (mm)					Kullanılan Uç Insert WSP	Sıkma Cıvatası Clamp Screw Torx-Schraube	Anahtar Torx Key Torx-Schlüssel
			Dmin	d	L	f	h			
KE30	●	E10K SDUCR 07	13	10	125	7	9,5			
KE31	●	E12M SDUCR 07	16	12	150	9	11,5			
KE32	●	E16R SDUCR 07	20	16	200	11	15,5			
KE33	●	E16R SDUCR 11	20	16	200	11	15,5	DCMT 11T3	TC067 M3,5x9	T15
KE34	●	E20S SDUCR 11	25	20	250	13	19,5			

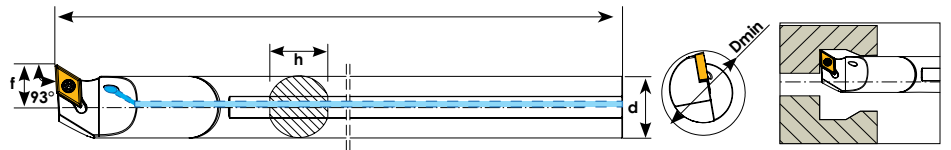
93° E-SDUCL IK

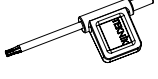

Sipariş Kodu Order Code Best.-Nr.	Stok/Stock/Lager	Ürün Kodu Product Code Produkt-Code	Ölçüler (mm) Dimensions(mm) Abmessungen (mm)					Kullanılan Uç Insert WSP	Sıkma Cıvatası Clamp Screw Torx-Schraube	Anahtar Torx Key Torx-Schlüssel
			Dmin	d	L	f	h			
KE40	●	E10K SDUCL 07	13	10	125	7	9,5			
KE41	●	E12M SDUCL 07	16	12	150	9	11,5			
KE42	●	E16R SDUCL 07	20	16	200	11	15,5			
KE43	●	E16R SDUCL 11	20	16	200	11	15,5	DCMT 11T3	TC067 M3,5x9	T15
KE44	●	E20S SDUCL 11	25	20	250	13	19,5			

**NEW
PRODUCT**

107,5° E-SDQCR IK

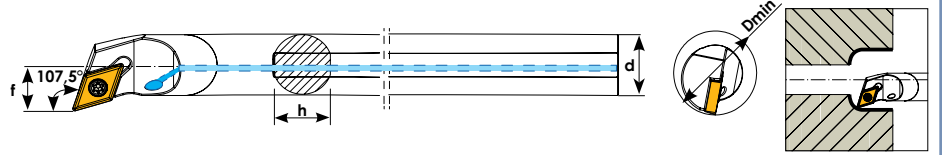

Sipariş Kodu Order Code Best.-Nr.	Stok/Stock/Lager	Ürün Kodu Product Code Produkt-Code	Ölçüler (mm) Dimensions(mm) Abmessungen (mm)					Kullanılan Uç Insert WSP	Sıkma Civatası Clamp Screw Torx-Schraube	Anahtar Torx Key Torx-Schlüssel
			Dmin	d	L	f	h			
KE50	●	E10K SDQCR 07	13	10	125	7	9,5	DCMT 0702	TC060 M2,5x5,5	T8
KE51	●	E12M SDQCR 07	16	12	150	9	11,5			
KE52	●	E16R SDQCR 07	20	16	200	11	15,5			
KE53	●	E16R SDQCR 11	20	16	200	11	15,5	DCMT 11T3	TC067 M3,5x9	T15
KE54	●	E20S SDQCR 11	25	20	250	13	19,5			

107,5° E-SDQCL IK

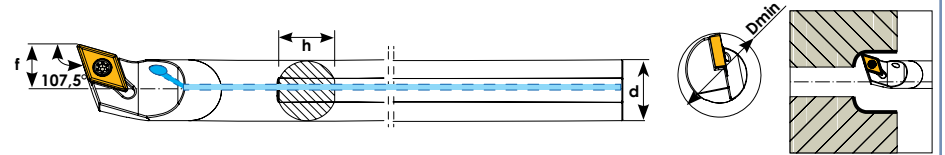

Sipariş Kodu Order Code Best.-Nr.	Stok/Stock/Lager	Ürün Kodu Product Code Produkt-Code	Ölçüler (mm) Dimensions(mm) Abmessungen (mm)					Kullanılan Uç Insert WSP	Sıkma Civatası Clamp Screw Torx-Schraube	Anahtar Torx Key Torx-Schlüssel
			Dmin	d	L	f	h			
KE60	●	E10K SDQCL 07	13	10	125	7	9,5	DCMT 0702	TC060 M2,5x5,5	T8
KE61	●	E12M SDQCL 07	16	12	150	9	11,5			
KE62	●	E16R SDQCL 07	20	16	200	11	15,5			
KE63	●	E16R SDQCL 11	20	16	200	11	15,5	DCMT 11T3	TC067 M3,5x9	T15
KE64	●	E20S SDQCL 11	25	20	250	13	19,5			



İç Çap Kater Set
Boring Bars Set
Bohrstange Set





SCLCR SET

Sipariş Kodu Order Code Best.-Nr.	Setteki Ürün Kodları Product Code In Set Produkt-Code in Set	Ölçüler (mm) Dimensions(mm) Abmessungen (mm)						Kullanılan Uç Insert WSP	Sıkma Cıvatası Clamp Screw Torx-Schraube	Anahtar Torx Key Torx-Schlüssel
		Dmin	d	L	L1	f	h			
İPS01	A08H SCLCR 06	10	8	100	16	5,5	7	CC-- 0602	TC060 M2,5x5,5	T8
	A10J SCLCR 06	12	10	110	20	6	9			
	A12K SCLCR 06	16	12	125	25	9	11			
	A16M SCLCR 09	20	16	150	30	11	15			

SCLCL SET

Sipariş Kodu Order Code Best.-Nr.	Setteki Ürün Kodları Product Code In Set Produkt-Code in Set	Ölçüler (mm) Dimensions(mm) Abmessungen (mm)						Kullanılan Uç Insert WSP	Sıkma Cıvatası Clamp Screw Torx-Schraube	Anahtar Torx Key Torx-Schlüssel
		Dmin	d	L	L1	f	h			
İPS04	A08H SCLCL 06	10	8	100	16	5,5	7	CC-- 0602	TC060 M2,5x5,5	T8
	A10J SCLCL 06	12	10	110	20	6	9			
	A12K SCLCL 06	16	12	125	25	9	11			
	A16M SCLCL 09	20	16	150	30	11	15			

SDUCR SET

Sipariş Kodu Order Code Best.-Nr.	Setteki Ürün Kodları Product Code In Set Produkt-Code in Set	Ölçüler (mm) Dimensions(mm) Abmessungen (mm)						Kullanılan Uç Insert WSP	Sıkma Cıvatası Clamp Screw Torx-Schraube	Anahtar Torx Key Torx-Schlüssel
		Dmin	d	L	L1	f	h			
İPS02	A10J SDUCR 07	12	10	110	20	7	9	DC--0702	TC060 M2,5x5,5	T8
	A12K SDUCR 07	16	12	125	25	9	11			
	A16M SDUCR 07	20	16	150	30	11	15			

SDUCL SET

Sipariş Kodu Order Code Best.-Nr.	Setteki Ürün Kodları Product Code In Set Produkt-Code in Set	Ölçüler (mm) Dimensions(mm) Abmessungen (mm)						Kullanılan Uç Insert WSP	Sıkma Cıvatası Clamp Screw Torx-Schraube	Anahtar Torx Key Torx-Schlüssel
		Dmin	d	L	L1	f	h			
İPS05	A10J SDUCL 07	12	10	110	20	7	9	DC--0702	TC060 M2,5x5,5	T8
	A12K SDUCL 07	16	12	125	25	9	11			
	A16M SDUCL 07	20	16	150	30	11	15			

SDQCR SET

Sipariş Kodu Order Code Best.-Nr.	Setteki Ürün Kodları Product Code In Set Produkt-Code in Set	Ölçüler (mm) Dimensions(mm) Abmessungen (mm)						Kullanılan Uç Insert WSP	Sıkma Cıvatası Clamp Screw Torx-Schraube	Anahtar Torx Key Torx-Schlüssel
		Dmin	d	L	L1	f	h			
İPS03	A10J SDQCR 07	12	10	110	20	7	9	DC--0702	TC060 M2,5x5,5	T8
	A12K SDQCR 07	16	12	125	25	9	11			
	A16M SDQCR 07	20	16	150	30	11	15			



SDQCL SET

Sipariş Kodu Order Code Best.-Nr.	Setteki Ürün Kodları Product Code In Set Produkt-Code in Set	Ölçüler (mm) Dimensions(mm) Abmessungen (mm)						Kullanılan Uç Insert WSP	Sıkma Cıvatası Clamp Screw Torx-Schraube	Anahtar Torx Key Torx-Schlüssel
		Dmin	d	L	L1	f	h			
İPS06	A10J SDQCL 07	12	10	110	20	7	9	DC--0702	TC060 M2,5x5,5	T8
	A12K SDQCL 07	16	12	125	25	9	11			
	A16M SDQCL 07	20	16	150	30	11	15			







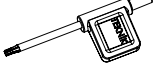

SCLCR SET

Sipariş Kodu Order Code Best.-Nr.	Setteki Ürün Kodları Product Code In Set Produkt-Code in Set	Ölçüler (mm) Dimensions(mm) Abmessungen (mm)						Kullanılan Uç Insert WSP	Sıkma Civatası Clamp Screw Torx-Schraube	Anahtar Torx Key Torx-Schlüssel
		Dmin	d	L	L1	f	h			
İPS20	S08H SCLCR 06	10	8	100	16	5,5	7			
	S10J SCLCR 06	12	10	110	20	6	9			
	S12K SCLCR 06	16	12	125	25	9	11			
	S16M SCLCR 09	20	16	150	30	11	15			
								CC-- 0602	TC060 M2,5x5,5	T8
								CC-- 09T3	TC067 M3,5x9	T15

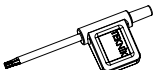

SCLCL SET

Sipariş Kodu Order Code Best.-Nr.	Setteki Ürün Kodları Product Code In Set Produkt-Code in Set	Ölçüler (mm) Dimensions(mm) Abmessungen (mm)						Kullanılan Uç Insert WSP	Sıkma Civatası Clamp Screw Torx-Schraube	Anahtar Torx Key Torx-Schlüssel
		Dmin	d	L	L1	f	h			
İPS21	S08H SCLCL 06	10	8	100	16	5,5	7			
	S10J SCLCL 06	12	10	110	20	6	9			
	S12K SCLCL 06	16	12	125	25	9	11			
	S16M SCLCL 09	20	16	150	30	11	15			
								CC-- 0602	TC060 M2,5x5,5	T8
								CC-- 09T3	TC067 M3,5x9	T15

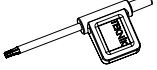

SDUCR SET

Sipariş Kodu Order Code Best.-Nr.	Setteki Ürün Kodları Product Code In Set Produkt-Code in Set	Ölçüler (mm) Dimensions(mm) Abmessungen (mm)						Kullanılan Uç Insert WSP	Sıkma Civatası Clamp Screw Torx-Schraube	Anahtar Torx Key Torx-Schlüssel
		Dmin	d	L	L1	f	h			
İPS22	S10J SDUCR 07	12	10	110	20	7	9			
	S12K SDUCR 07	16	12	125	25	9	11			
	S16M SDUCR 11	20	16	150	30	11	15			
								DC--0702	TC060 M2,5x5,5	T8
								DC--11T3	TC067 M3,5x9	T15

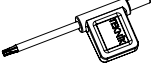

SDUCL SET

Sipariş Kodu Order Code Best.-Nr.	Setteki Ürün Kodları Product Code In Set Produkt-Code in Set	Ölçüler (mm) Dimensions(mm) Abmessungen (mm)						Kullanılan Uç Insert WSP	Sıkma Civatası Clamp Screw Torx-Schraube	Anahtar Torx Key Torx-Schlüssel
		Dmin	d	L	L1	f	h			
İPS23	S10J SDUCL 07	12	10	110	20	7	9			
	S12K SDUCL 07	16	12	125	25	9	11			
	S16M SDUCL 11	20	16	150	30	11	15			
								DC--0702	TC060 M2,5x5,5	T8
								DC--11T3	TC067 M3,5x9	T15

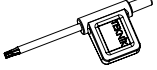
SDQCR SET

Sipariş Kodu Order Code Best.-Nr.	Setteki Ürün Kodları Product Code In Set Produkt-Code in Set	Ölçüler (mm) Dimensions(mm) Abmessungen (mm)						Kullanılan Uç Insert WSP	Sıkma Civatası Clamp Screw Torx-Schraube	Anahtar Torx Key Torx-Schlüssel
		Dmin	d	L	L1	f	h			
İPS24	S10J SDQCR 07	12	10	110	20	7	9			
	S12K SDQCR 07	16	12	125	25	9	11			
	S16M SDQCR 11	20	16	150	30	11	15			
								DC--0702	TC060 M2,5x5,5	T8
								DC--11T3	TC067 M3,5x9	T15

SDQCL SET

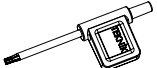
Sipariş Kodu Order Code Best.-Nr.	Setteki Ürün Kodları Product Code In Set Produkt-Code in Set	Ölçüler (mm) Dimensions(mm) Abmessungen (mm)						Kullanılan Uç Insert WSP	Sıkma Civatası Clamp Screw Torx-Schraube	Anahtar Torx Key Torx-Schlüssel
		Dmin	d	L	L1	f	h			
İPS25	S10J SDQCL 07	12	10	110	20	7	9			
	S12K SDQCL 07	16	12	125	25	9	11			
	S16M SDQCL 11	20	16	150	30	11	15			
								DC--0702	TC060 M2,5x5,5	T8
								DC--11T3	TC067 M3,5x9	T15



U-Drill
Indexable Insert Drills Voll-
bohrer

www.teknikcuttingtools.com



U-DRİLL EKSANTRİK ADAPTÖRÜ
ADAPTOR FOR U-DRILLS

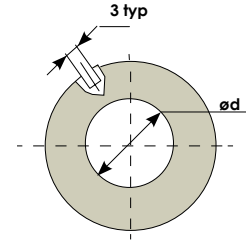
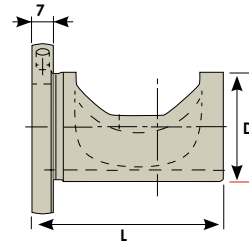

Adaptörün radyal olarak ayarlanmasını kolaylaştırmak için kullanılır.
(This pin used to ease radial adjustment of the sleeve.)

Sipariş Kodu Order Code Best.-Nr.	Stok/Stock/Lager	Ürün Kodu Product Code Produkt-Code	Ölçüler (mm) Dimensions (mm) Abmessungen (mm)		
			D	d	L
UA 10	●	D25 d20 L46	25	20	46,5
UA 12	●	D32 d25 L47	32	25	47
UA 14	●	D40 d32 L57	40	32	57

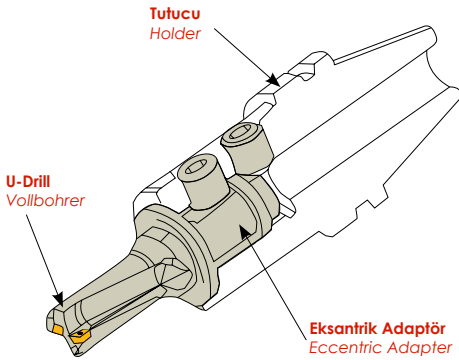

Frezeleme tezgahında takma uçlu matkabin nominal çapı, matkabin ekseninin, sipindile eksenine göre ötelenmesiyle değişebilir.

On a milling machine the drill's nominal diameter can be changed by shifting the drill's axis out of the tool spindle.

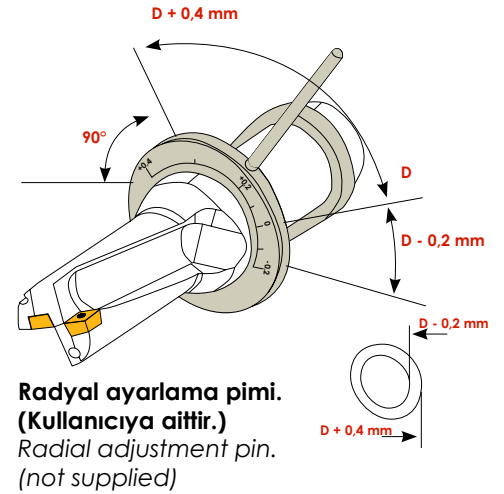
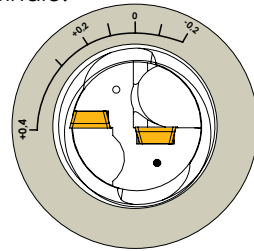

Radyal ayarlama pimi.
(Kullanıcıya aittir.)
Radial adjustment pin.
(not supplied)

Delik Çapı
Hole Diameter
24,8 mm



U-Drill Çapı
Drill Diameter
25 mm

Delik Çapı
Hole Diameter
25 mm



U-Drill Çapı
Drill Diameter
25 mm

Delik Çapı
Hole Diameter
25,4 mm



U-Drill Çapı
Drill Diameter
25 mm

U-Drill'in üzerindeki düz çizgi adaptörün sıfır rakamının üzerine konulmalıdır.

AET'nin (eksantrik adaptörün) çevrilmesini kolaylaştırmak için AET'nin üzerindeki deliğe, metal bir çubuk ya da vida anahtarını yerleştirilebilir. AET'yi ayarlamadan önce tutucunun vidasını hafifçe çözün.

The adjustment marking should be located perpendicular to the flat on the circumference of the U-DRILL flange.

To facilitate the rotation of the adaptor, a metal rod or a screw key may be inserted into a hole on the exentric adaptor flange. Unlock adapter screw before adjusting adaptor.

U1
D2 WCMX

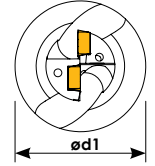
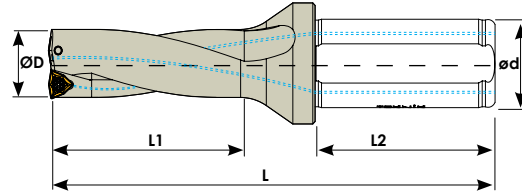

Sipariş Kodu Order Code Best.-Nr.	Stok/Stock/Lager	Ürün Kodu Product Code Produkt-Code	Ölçüler (mm) Dimensions (mm) Abmessungen (mm)						Kullanılan Uç Insert WSP	Sıkma Cıvatası Clamp Screw Torx-Schraube	Anahtar Torx Key Torx-Schlüssel
			ØD	ød	d1	L	L1	L2			
U104	●	16 D2 WCMX 03	16	25	34	108	32	56	WCMX 0302 KRLY	TC060 M2,5x5,5	T8
U105	●	17 D2 WCMX 03	17	25	34	110	34	56			
U106	●	18 D2 WCMX 03	18	25	34	113	36	56			
U107	●	19 D2 WCMX 03	19	25	34	115	38	56			
U108	●	20 D2 WCMX 04	20	25	34	119	40	56	WCMX 0402 KRLY	TC065 M3x7	T15
U110	●	21 D2 WCMX 04	21	25	34	121	42	56			
U112	●	22 D2 WCMX 04	22	25	34	123	44	56			
U114	●	23 D2 WCMX 04	23	25	34	127	46	56			
U116	●	24 D2 WCMX 05	24	25	34	130	48	56	WCMX 0503 KRLY	TC067 M3,5x9	T15
U118	●	25 D2 WCMX 05	25	25	34	133	50	56			
U120	●	26 D2 WCMX 05	26	25	34	135	52	56			
U122	●	27 D2 WCMX 05	27	25	34	137	54	56			
U124	●	28 D2 WCMX 05	28	25	39	140	56	56	WCMX 06T3 KRLY	TC067 M3,5x9	T15
U126	●	29 D2 WCMX 05	29	25	39	142	58	56			
U128	●	30 D2 WCMX 06	30	32	44	151	60	58			
U130	●	31 D2 WCMX 06	31	32	44	154	62	58			
U132	●	32 D2 WCMX 06	32	32	44	156	64	58			
U134	●	33 D2 WCMX 06	33	32	44	159	66	58			
U136	●	34 D2 WCMX 06	34	32	44	161	68	58			
U137	●	35 D2 WCMX 06	35	32	44	164	70	58			
U138	●	36 D2 WCMX 06	36	32	44	167	72	58			
U139	●	37 D2 WCMX 06	37	32	44	170	74	58			
U140	●	38 D2 WCMX 06	38	32	44	173	76	58			
U141	●	39 D2 WCMX 06	39	32	44	175	78	58			
U142	●	40 D2 WCMX 06	40	32	44	178	80	58			

KRLY ucuna uygundur. / Compatible with KRLY insert. / Kompatible für KRLY WP

U2
D3 WCMX

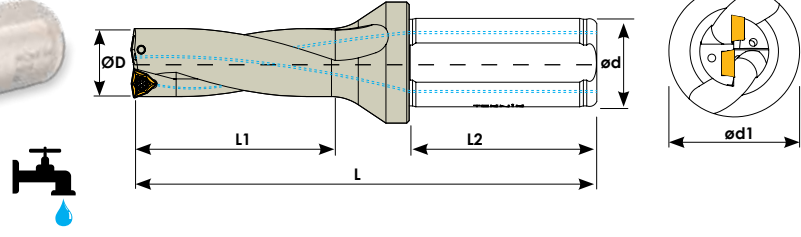

Sipariş Kodu Order Code Best.-Nr.	Stok/Stock/Lager	Ürün Kodu Product Code Produkt-Code	Ölçüler (mm) Dimensions (mm) Abmessungen (mm)							Kullanılan Uç Insert WSP	Sıkma Civatası Clamp Screw Torx-Schraube	Anahtar Torx Key Torx-Schlüssel
			ØD	ød	d1	L	L1	L2				
U143	●	16 D3 WCMX 03	16	25	34	124	48	56	WCMX 0302 KRLY	TC060 M2,5x5,5	T8	
U143-1	●	16,5 D3 WCMX 03	16,5	25	34	124	48	56				
U144	●	17 D3 WCMX 03	17	25	34	127	51	56				
U145	●	17,5 D3 WCMX 03	17,5	25	34	127	51	56				
U146	●	18 D3 WCMX 03	18	25	34	131	54	56				
U147	●	18,5 D3 WCMX 03	18,5	25	34	131	54	56				
U148	●	19 D3 WCMX 03	19	25	34	134	57	56				
U149	●	19,5 D3 WCMX 03	19,5	25	34	134	57	56				
U150	●	20 D3 WCMX 04	20	25	34	139	60	56				WCMX 0402 KRLY
U151	●	20,5 D3 WCMX 04	20,5	25	34	139	60	56				
U152	●	21 D3 WCMX 04	21	25	34	142	63	56				
U153	●	21,5 D3 WCMX 04	21,5	25	34	142	63	56				
U154	●	22 D3 WCMX 04	22	25	34	145	66	56				
U155	●	22,5 D3 WCMX 04	22,5	25	34	145	66	56				
U156	●	23 D3 WCMX 04	23	25	34	150	69	56				
U157	●	23,5 D3 WCMX 04	23,5	25	34	150	69	56				
U158	●	24 D3 WCMX 05	24	25	34	154	72	56	WCMX 0503 KRLY	TC065 M3x7		
U159	●	24,5 D3 WCMX 05	24,5	25	34	154	72	56				
U160	●	25 D3 WCMX 05	25	25	34	158	75	56				
U161	●	25,5 D3 WCMX 05	25,5	25	34	158	75	56				
U162	●	26 D3 WCMX 05	26	25	34	161	78	56				
U163	●	26,5 D3 WCMX 05	26,5	25	34	161	78	56				
U164	●	27 D3 WCMX 05	27	25	34	164	81	56				
U165	●	27,5 D3 WCMX 05	27,5	25	34	164	81	56				
U166	●	28 D3 WCMX 05	28	25	39	168	84	56				
U167	●	28,5 D3 WCMX 05	28,5	25	39	168	84	56				
U168	●	29 D3 WCMX 05	29	25	39	171	87	56				
U169	●	29,5 D3 WCMX 05	29,5	25	39	171	87	56				

KRLY ucuna uygundur. / Compatible with KRLY insert. / Kompatible für KRLY WP

U2
D3 WCMX

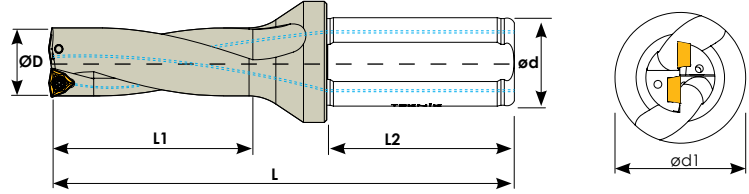

Sipariş Kodu Order Code Best.-Nr.	Stok/Stock/Lager	Ürün Kodu Product Code Produkt-Code	Ölçüler (mm) Dimensions(mm) Abmessungen (mm)						Kullanılan Uç Insert WSP	Sıkma Cıvatası Clamp Screw Torx-Schraube	Anahtar Torx Key Torx-Schlüssel
			ØD	ød	d1	L	L1	L2			
U170	●	30 D3 WCMX 06	30	32	44	181	90	58	WCMX 06T3 KRLY	TC067 M3,5x9	T15
U171	●	30,5 D3 WCMX 06	30,5	32	44	181	90	58			
U172	●	31 D3 WCMX 06	31	32	44	185	93	58			
U174	●	32 D3 WCMX 06	32	32	44	188	96	58			
U176	●	33 D3 WCMX 06	33	32	44	192	99	58			
U178	●	34 D3 WCMX 06	34	32	44	195	102	58			
U179	●	35 D3 WCMX 06	35	32	44	199	105	58			
U180	●	36 D3 WCMX 06	36	32	44	203	108	58			
U181	●	37 D3 WCMX 06	37	32	44	207	111	58			
U182	●	38 D3 WCMX 06	38	32	44	211	114	58			
U183	●	39 D3 WCMX 06	39	32	44	214	117	58			
U184	●	40 D3 WCMX 06	40	32	44	218	120	58			
U186	●	41 D3 WCMX 06	41	32	49	232	123	58			
U188	●	42 D3 WCMX 06	42	32	49	235	126	58			
U190	●	43 D3 WCMX 06	43	32	54	239	129	58			
U192	●	44 D3 WCMX 06	44	32	54	242	132	58			
U194	●	45 D3 WCMX 06	45	40	59	247	135	68			
U196	●	46 D3 WCMX 08	46	40	59	251	138	68			
U198	●	47 D3 WCMX 08	47	40	59	254	141	68			
U200	●	48 D3 WCMX 08	48	40	59	258	144	68			
U201	●	49 D3 WCMX 08	49	40	59	261	147	68			
U202	●	50 D3 WCMX 08	50	40	59	265	150	68			
U203	●	51 D3 WCMX 08	51	40	59	268	153	68			
U205	●	52 D3 WCMX 08	52	40	59	271	156	68			
U207	●	53 D3 WCMX 08	53	40	59	274	159	68			
U209	●	54 D3 WCMX 08	54	40	59	277	162	68			
U211	●	55 D3 WCMX 08	55	40	59	280	165	68			

KRLY ucuna uygundur. / Compatible with KRLY insert. / Kompatible für KRLY WP

U3
D4 WCMX

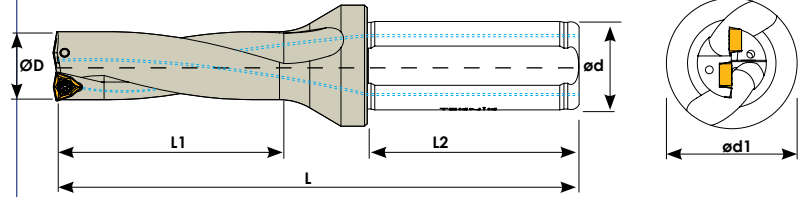



Sipariş Kodu Order Code Best.-Nr.	Stok/Stock/Lager	Ürün Kodu Product Code Produkt-Code	Öçüler (mm) Dimensions(mm) Abmessungen (mm)							Kullanılan Uç Insert WSP	Sıkma Cıvatası Clamp Screw Torx-Schraube	Anahtar Torx Key Torx-Schlüssel
			ØD	ød	d1	L	L1	L2				
U600	●	16 D4 WCMX 03	16	25	34	140	64	56	WCMX 0302 KRLY	TC060 M2,5x5,5	T8	
U602	●	17 D4 WCMX 03	17	25	34	144	68	56				
U604	●	18 D4 WCMX 03	18	25	34	149	72	56				
U606	●	19 D4 WCMX 03	19	25	34	153	76	56				
U608	●	20 D4 WCMX 04	20	25	34	159	80	56	WCMX 0402 KRLY			
U610	●	21 D4 WCMX 04	21	25	34	163	84	56				
U612	●	22 D4 WCMX 04	22	25	34	167	88	56				
U614	●	23 D4 WCMX 04	23	25	34	173	92	56				
U616	●	24 D4 WCMX 05	24	25	34	178	96	56	WCMX 0503 KRLY			
U618	●	25 D4 WCMX 05	25	25	34	183	100	56				
U620	●	26 D4 WCMX 05	26	25	34	187	104	56				
U622	●	27 D4 WCMX 05	27	25	34	191	108	56				
U624	●	28 D4 WCMX 05	28	25	39	196	112	56				
U626	●	29 D4 WCMX 05	29	25	39	200	116	56				
U628	●	30 D4 WCMX 06	30	32	44	211	120	58	WCMX 06T3 KRLY	TC067 M3,5x9	T15	
U631	●	31 D4 WCMX 06	31	32	44	216	124	58				
U632	●	32 D4 WCMX 06	32	32	44	220	128	58				
U633	●	33 D4 WCMX 06	33	32	44	225	132	58				
U634	●	34 D4 WCMX 06	34	32	44	229	136	58				
U635	●	35 D4 WCMX 06	35	32	44	234	140	58				
U636	●	36 D4 WCMX 06	36	32	44	239	144	58				
U637	●	37 D4 WCMX 06	37	32	44	244	148	58				
U638	●	38 D4 WCMX 06	38	32	44	249	152	58				
U639	●	39 D4 WCMX 06	39	32	44	253	156	58				
U640	●	40 D4 WCMX 06	40	32	44	258	160	58				

KRLY ucuna uygundur. / Compatible with KRLY insert. / Kompatible für KRLY WP

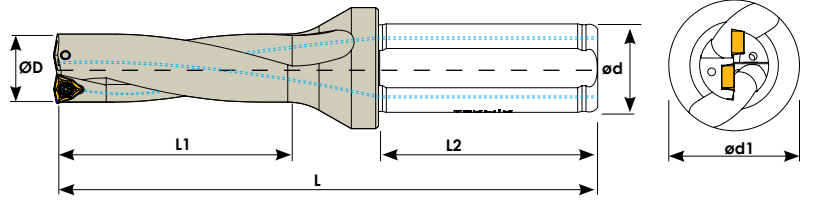
U4
D5 WCMX

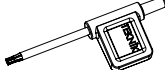

Sipariş Kodu Order Code Best.-Nr.	Stok/Stock/Lager	Ürün Kodu Product Code Produkt-Code	Ölçüler (mm) Dimensions (mm) Abmessungen (mm)						Kullanılan Uç Insert WSP	Sıkma Cıvatası Clamp Screw Torx-Schraube	Anahtar Torx Key Torx-Schlüssel	
			ØD	ød	d1	L	L1	L2				
U776	○	16 D5 WCMX 03	16	25	34	156	80	56	WCMX 0302 KRLY	TC060 M2,5x5,5	T8	
U777	○	17 D5 WCMX 03	17	25	34	161	85	56				
U778	○	18 D5 WCMX 03	18	25	34	167	90	56				
U779	○	19 D5 WCMX 03	19	25	34	172	95	56				
U780	○	20 D5 WCMX 04	20	25	34	179	100	56	WCMX 0402 KRLY	TC065 M3x7		
U781	○	21 D5 WCMX 04	21	25	34	184	105	56				
U782	○	22 D5 WCMX 04	22	25	34	190	110	56				
U783	○	23 D5 WCMX 04	23	25	34	196	115	56				
U784	○	24 D5 WCMX 05	24	25	34	202	120	56	WCMX 0503 KRLY		TC067 M3,5x9	
U785	○	25 D5 WCMX 05	25	25	34	208	125	56				
U786	○	26 D5 WCMX 05	26	25	34	213	130	56				
U787	○	27 D5 WCMX 05	27	25	34	218	135	56				
U788	○	28 D5 WCMX 05	28	25	39	224	140	56	WCMX 06T3 KRLY	TC067 M3,5x9		
U789	○	29 D5 WCMX 05	29	25	39	229	145	56				
U790	○	30 D5 WCMX 06	30	32	44	241	150	58				
U791	○	31 D5 WCMX 06	31	32	44	216	155	58				
U792	○	32 D5 WCMX 06	32	32	44	252	160	58	WCMX 06T3 KRLY		TC067 M3,5x9	
U793	○	33 D5 WCMX 06	33	32	44	258	165	58				
U794	○	34 D5 WCMX 06	34	32	44	263	170	58				
U795	○	35 D5 WCMX 06	35	32	44	269	175	58				
U796	○	36 D5 WCMX 06	36	32	44	275	180	58	WCMX 06T3 KRLY	TC067 M3,5x9		
U797	○	37 D5 WCMX 06	37	32	44	281	185	58				
U798	○	38 D5 WCMX 06	38	32	44	287	190	58				
U799	○	39 D5 WCMX 06	39	32	44	292	195	58				
U800	○	40 D5 WCMX 06	40	32	44	298	200	58				T15

KRLY ucuna uygundur. / Compatible with KRLY insert. / Kompatible für KRLY WP

U5
D2 SPMG

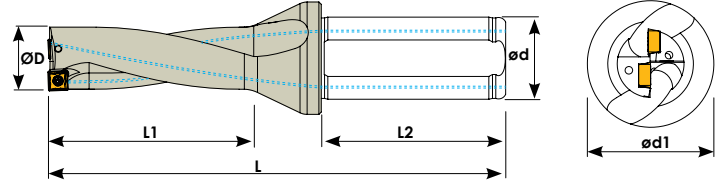

Sipariş Kodu Order Code Best.-Nr.	Stok/Stock/Lager	Ürün Kodu Product Code Produkt-Code	Ölçüler (mm) Dimensions (mm) Abmessungen (mm)						Kullanılan Uç Insert WSP	Sıkma Cıvatası Clamp Screw Torx-Schraube	Anahtar Torx Key Torx-Schlüssel
			ØD	ød	d1	L	L1	L2			
U913	●	13 D2 SPMG 05	13	20	25	94	26	50	SPMG 0502 TGTC	TC058 M2x4,2	T6
U914	●	14 D2 SPMG 05	14	20	25	96	28	50			
U915	●	15 D2 SPMG 05	15	20	25	99	30	50			
U916	●	16 D2 SPMG 06	16	25	34	108	32	56	SPMG 0602 TGTC	TC059 M2,2x5	T7
U917	●	17 D2 SPMG 06	17	25	34	110	34	56			
U918	●	18 D2 SPMG 06	18	25	34	113	36	56			
U919	●	19 D2 SPMG 06	19	25	34	115	38	56			
U920	●	20 D2 SPMG 06	20	25	34	119	40	56			
U921	●	21 D2 SPMG 06	21	25	34	121	42	56			
U922	●	22 D2 SPMG 07	22	25	34	123	44	56	SPMG 07T3 TGTC	TC063 M2,5x7	T8
U923	●	23 D2 SPMG 07	23	25	34	127	46	56			
U924	●	24 D2 SPMG 07	24	25	34	130	48	56			
U925	●	25 D2 SPMG 07	25	25	34	133	50	56			
U926	●	26 D2 SPMG 07	26	25	34	135	52	56			
U927	●	27 D2 SPMG 07	27	25	34	137	54	56			
U928	●	28 D2 SPMG 09	28	25	39	140	56	56	SPMG 0904 TGTC	TC067 M3,5x9	T15
U929	●	29 D2 SPMG 09	29	25	39	142	58	56			
U930	●	30 D2 SPMG 09	30	32	44	151	60	58			
U931	●	31 D2 SPMG 09	31	32	44	154	62	58			
U932	●	32 D2 SPMG 09	32	32	44	156	64	58			
U933	●	33 D2 SPMG 09	33	32	44	159	66	58			
U934	●	34 D2 SPMG 11	34	32	44	161	68	58	SPMG 1104 TGTC	TC074 M4x10	T15
U935	●	35 D2 SPMG 11	35	32	44	164	70	58			
U936	●	36 D2 SPMG 11	36	32	44	167	72	58			
U937	●	37 D2 SPMG 11	37	32	44	170	74	58			
U938	●	38 D2 SPMG 11	38	32	44	173	76	58			
U939	●	39 D2 SPMG 11	39	32	44	175	78	58			
U940	●	40 D2 SPMG 11	40	32	44	178	80	58			

TGTCucuna uygundur. / Compatible with TGTCinsert. / Kompatible für TGTCWP

U6
D3 SPMG

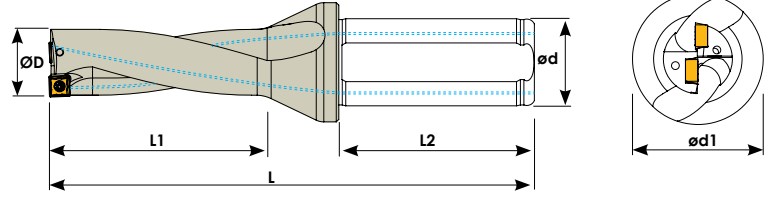

Sipariş Kodu Order Code Best.-Nr.	Stok/Stock/Lager	Ürün Kodu Product Code Produkt-Code	Ölçüler (mm) Dimensions (mm) Abmessungen (mm)							Kullanılan Uç Insert WSP	Sıkma Civatası Clamp Screw Torx-Schraube	Anahtar Torx Key Torx-Schlüssel
			ØD	ød	d1	L	L1	L2				
U812	●	12,5 D3 SPMG 05	12,5	20	12	106	38	50	SPMG 0502 TGTC	TC058 M2x4,2	T6	
U813	●	13 D3 SPMG 05	13	20	25	107	39	50				
U813-1	●	13,5 D3 SPMG 05	13,5	20	25	107	39	50				
U814	●	14 D3 SPMG 05	14	20	25	110	42	50				
U814-1	●	14,5 D3 SPMG 05	14,5	20	25	110	42	50				
U815	●	15 D3 SPMG 05	15	20	25	114	45	50				
U815-1	●	15,5 D3 SPMG 05	15,5	20	25	114	45	50				
U816	●	16 D3 SPMG 06	16	25	34	124	48	56	SPMG 0602 TGTC	TC059 M2,2x5	T7	
U816-1	●	16,5 D3 SPMG 06	16,5	25	34	124	48	56				
U817	●	17 D3 SPMG 06	17	25	34	127	51	56				
U817-1	●	17,5 D3 SPMG 06	17,5	25	34	127	51	56				
U818	●	18 D3 SPMG 06	18	25	34	131	54	56				
U818-1	●	18,5 D3 SPMG 06	18,5	25	34	131	54	56				
U819	●	19 D3 SPMG 06	19	25	34	134	57	56				
U819-1	●	19,5 D3 SPMG 06	19,5	25	34	134	57	56				
U820	●	20 D3 SPMG 06	20	25	34	139	60	56				
U820-1	●	20,5 D3 SPMG 06	20,5	25	34	139	60	56				
U821	●	21 D3 SPMG 06	21	25	34	142	63	56	SPMG 07T3 TGTC	TC063 M2,5x7	T8	
U821-1	●	21,5 D3 SPMG 06	21,5	25	34	142	63	56				
U822	●	22 D3 SPMG 07	22	25	34	145	66	56				
U822-1	●	22,5 D3 SPMG 07	22,5	25	34	145	66	56				
U823	●	23 D3 SPMG 07	23	25	34	150	69	56				
U823-1	●	23,5 D3 SPMG 07	23,5	25	34	150	69	56				
U824	●	24 D3 SPMG 07	24	25	34	154	72	56				
U824-1	●	24,5 D3 SPMG 07	24,5	25	34	154	72	56				
U825	●	25 D3 SPMG 07	25	25	34	158	75	56				
U825-1	●	25,5 D3 SPMG 07	25,5	25	34	158	75	56				
U826	●	26 D3 SPMG 07	26	25	34	161	78	56	SPMG 07T3 TGTC	TC063 M2,5x7	T8	
U826-1	●	26,5 D3 SPMG 07	26,5	25	34	161	78	56				
U827	●	27 D3 SPMG 07	27	25	34	164	81	56				
U827-1	●	27,5 D3 SPMG 07	27,5	25	34	164	81	56				

TGTCucuna uygundur. / Compatible with TGTCinsert. / Kompatibel für TGTCWP

U6
D3 SPMG

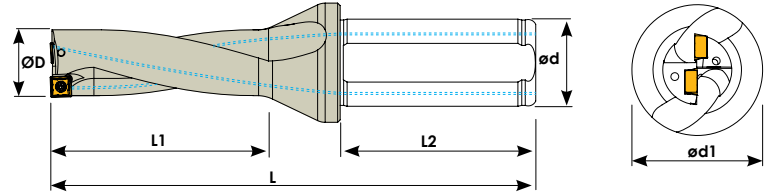

Sipariş Kodu Order Code Best.-Nr.	Stok/Stock/Lager	Ürün Kodu Product Code Produkt-Code	Ölçüler (mm) Dimensions (mm) Abmessungen (mm)							Kullanılan Uç Insert WSP	Sıkma Cıvatası Clamp Screw Torx-Schraube	Anahtar Torx Key Torx-Schlüssel		
			ØD	ød	d1	L	L1	L2						
U828	●	28 D3 SPMG 09	28	25	39	168	84	56	SPMG 0904 TGTC	TC067 M3,5x9	T15			
U828-1	●	28,5 D3 SPMG 09	28,5	25	39	168	84	56						
U829	●	29 D3 SPMG 09	29	25	39	171	87	56						
U829-1	●	29,5 D3 SPMG 09	29,5	25	39	171	87	56						
U830	●	30 D3 SPMG 09	30	32	44	181	90	58						
U831	●	31 D3 SPMG 09	31	32	44	185	93	58						
U832	●	32 D3 SPMG 09	32	32	44	188	96	58						
U833	●	33 D3 SPMG 09	33	32	44	192	99	58						
U834	●	34 D3 SPMG 11	34	32	44	195	102	58				SPMG 1104 TGTC	TC074 M4x10	T15
U835	●	35 D3 SPMG 11	35	32	44	199	105	58						
U836	●	36 D3 SPMG 11	36	32	44	203	108	58						
U837	●	37 D3 SPMG 11	37	32	44	207	111	58						
U838	●	38 D3 SPMG 11	38	32	44	211	114	58						
U839	●	39 D3 SPMG 11	39	32	44	214	117	58						
U840	●	40 D3 SPMG 11	40	32	44	218	120	58						

TGTCucuna uygundur. / Compatible with TGTCinsert. / Kompatible für TGTCWP

U7
D4 SPMG

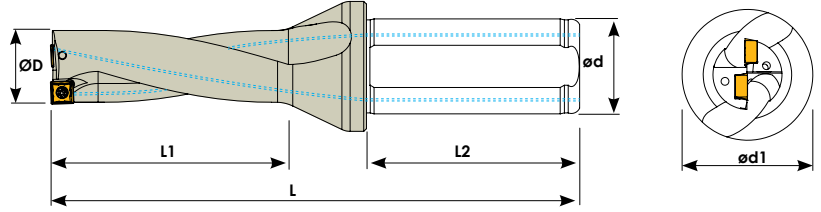

Sipariş Kodu Order Code Bestf.-Nr.	Stok/Stock/Lager	Ürün Kodu Product Code Produkt-Code	Ölçüler (mm) Dimensions (mm) Abmessungen (mm)						Kullanılan Uç Insert WSP	Sıkma Civatası Clamp Screw Torx-Schraube	Anahtar Torx Key Torx-Schlüssel
			ØD	ød	d1	L	L1	L2			
U713	●	13 D4 SPMG 05	13	20	25	120	52	50	SPMG 0502 TGTC	TC058 M2x4,2	T6
U714	●	14 D4 SPMG 05	14	20	25	124	56	50			
U715	●	15 D4 SPMG 05	15	20	25	129	60	50			
U716	●	16 D4 SPMG 06	16	25	34	140	64	56	SPMG 0602 TGTC	TC059 M2,2x5	T7
U717	●	17 D4 SPMG 06	17	25	34	144	68	56			
U718	●	18 D4 SPMG 06	18	25	34	149	72	56			
U719	●	19 D4 SPMG 06	19	25	34	153	76	56			
U720	●	20 D4 SPMG 06	20	25	34	159	80	56			
U721	●	21 D4 SPMG 06	21	25	34	163	84	56			
U722	●	22 D4 SPMG 07	22	25	34	167	88	56	SPMG 07T3 TGTC	TC063 M2,5x7	T8
U723	●	23 D4 SPMG 07	23	25	34	173	92	56			
U724	●	24 D4 SPMG 07	24	25	34	178	96	56			
U725	●	25 D4 SPMG 07	25	25	34	183	100	56			
U726	●	26 D4 SPMG 07	26	25	34	187	104	56			
U727	●	27 D4 SPMG 07	27	25	34	191	108	56			
U728	●	28 D4 SPMG 09	28	25	39	196	112	56	SPMG 0904 TGTC	TC067 M3,5x9	T15
U729	●	29 D4 SPMG 09	29	25	39	200	116	56			
U730	●	30 D4 SPMG 09	30	32	44	211	120	58			
U731	●	31 D4 SPMG 09	31	32	44	216	124	58			
U732	●	32 D4 SPMG 09	32	32	44	220	128	58			
U733	●	33 D4 SPMG 09	33	32	44	225	132	58			
U734	●	34 D4 SPMG 11	34	32	44	229	136	58	SPMG 1104 TGTC	TC074 M4x10	T15
U735	●	35 D4 SPMG 11	35	32	44	234	140	58			
U736	●	36 D4 SPMG 11	36	32	44	239	144	58			
U737	●	37 D4 SPMG 11	37	32	44	244	148	58			
U738	●	38 D4 SPMG 11	38	32	44	249	152	58			
U739	●	39 D4 SPMG 11	39	32	44	253	156	58			
U740	●	40 D4 SPMG 11	40	32	44	258	160	58			

TGTCucuna uygundur. / Compatible with TGTCinsert. / Kompatible für TGTCWP

**U8
D3 SPMT**

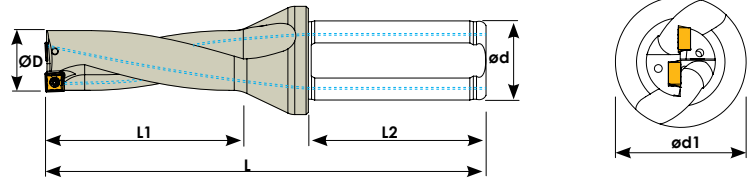

Sipariş Kodu Order Code Best.-Nr.	Stok/Stock/Lager	Ürün Kodu Product Code Produkt-Code	Ölçüler (mm) Dimensions (mm) Abmessungen (mm)						Kullanılan Uç Insert WSP	Sıkma Cıvatası Clamp Screw Torx-Schraube	Anahtar Torx Key Torx-Schlüssel
			ØD	ød	d1	L	L1	L2			
U004	●	13 D3 SPMT 05	13	20	25	107	39	50	SPMT 0502 KRLY	TC058 M2x4,2	T6
U006	●	14 D3 SPMT 05	14	20	25	110	42	50			
U008	●	15 D3 SPMT 05	15	20	25	114	45	50			
U010	●	16 D3 SPMT 06	16	25	34	124	48	56	SPMT 0602 KRLY	TC059 M2,2x5	T7
U012	●	17 D3 SPMT 06	17	25	34	127	51	56			
U014	●	18 D3 SPMT 06	18	25	34	131	54	56			
U016	●	19 D3 SPMT 06	19	25	34	134	57	56			
U018	●	20 D3 SPMT 07	20	25	34	139	60	56	SPMT 0702 KRLY	TC063 M2,5x7	T8
U020	●	21 D3 SPMT 07	21	25	34	142	63	56			
U022	●	22 D3 SPMT 07	22	25	34	145	66	56			

KRLY ucuna uygundur. / Compatible with KRLY insert. / Kompatible für KRLY WP



D3 SOMT U9

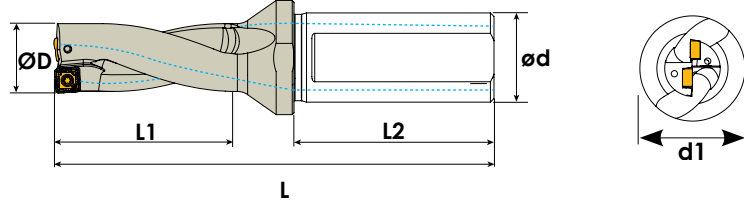

Sipariş Kodu Order Code Best.-Nr.	Stok/Stock/Lager	Ürün Kodu Product Code Produkt-Code	Ölçüler (mm) Dimensions (mm) Abmessungen (mm)						Kullanılan Uç Insert WSP	Sıkma Cıvatası Clamp Screw Torx-Schraube	Anahtar Torx Key Torx-Schlüssel
			ØD	ød	d1	L	L1	L2			
U300	●	13 D3 SOMT 05	13	20	25	111	39	50	SOMT 0502 TGTC	TC058 M2x4,2	T6
U302	●	14 D3 SOMT 05	14	20	25	114	42	50			
U303	●	14,5 D3 SOMT 05	14,5	20	25	114	42	50			
U304	●	15 D3 SOMT 05	15	20	25	117	45	50			
U305	●	15,5 D3 SOMT 05	15,5	20	25	117	45	50			
U306	●	16 D3 SOMT 05	16	25	34	126	48	56			
U307	●	16,5 D3 SOMT 06	16,5	25	34	126	48	56	SOMT 0602 TGTC	TC059 M2,2x5	T7
U308	●	17 D3 SOMT 06	17	25	34	129	51	56			
U309	●	17,5 D3 SOMT 06	17,5	25	34	129	51	56			
U310	●	18 D3 SOMT 06	18	25	34	132	54	56			
U311	●	18,5 D3 SOMT 06	18,5	25	34	132	54	56			
U312	●	19 D3 SOMT 06	19	25	34	135	57	56			
U313	●	19,5 D3 SOMT 07	19,5	25	34	135	57	56	SOMT 0703 TGTC		
U314	●	20 D3 SOMT 07	20	25	34	138	60	56			
U315	●	20,5 D3 SOMT 07	20,5	25	34	138	60	56	SOMT 08T3 TGTC	TC063 M2,5x7	T8
U316	●	21 D3 SOMT 07	21	25	34	141	63	56			
U318	●	22 D3 SOMT 08	22	25	34	144	66	56			
U319	●	22,5 D3 SOMT 08	22,5	25	34	144	66	56			
U320	●	23 D3 SOMT 08	23	25	34	147	69	56			
U321	●	23,5 D3 SOMT 08	23,5	25	34	147	69	56			
U322	●	24 D3 SOMT 08	24	25	34	150	72	56			
U323	●	24,5 D3 SOMT 08	24,5	25	34	150	72	56			
U324	●	25 D3 SOMT 08	25	25	34	153	75	56			

D4 SOMT U10

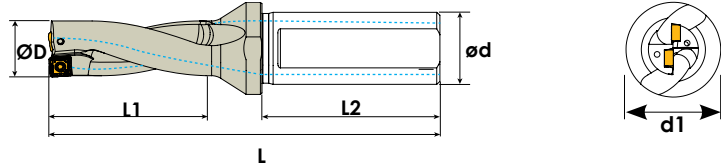

Sipariş Kodu Order Code Best.-Nr.	Stok/Stock/Lager	Ürün Kodu Product Code Produkt-Code	Ölçüler (mm) Dimensions (mm) Abmessungen (mm)						Kullanılan Uç Insert WSP	Sıkma Cıvatası Clamp Screw Torx-Schraube	Anahtar Torx Key Torx-Schlüssel
			ØD	ød	d1	L	L1	L2			
U402	●	14 D4 SOMT 05	14	20	25	128	56	50	SOMT 0502 TGTC	TC058 M2x4,2	T6
U403	●	14,5 D4 SOMT 05	14,5	20	25	128	56	50			
U406	●	16 D4 SOMT 05	16	25	34	142	64	56			
U408	●	17 D4 SOMT 06	17	25	34	146	68	56	SOMT 0602 TGTC	TC059 M2,2x5	T7
U409	●	17,5 D4 SOMT 06	17,5	25	34	146	68	56			
U410	●	18 D4 SOMT 06	18	25	34	150	72	56			
U412	●	19 D4 SOMT 06	19	25	34	154	76	56			
U414	●	20 D4 SOMT 07	20	25	34	158	8	56	SOMT 0703 TGTC		
U416	●	21 D4 SOMT 07	21	25	34	162	84	56			
U418	●	22 D4 SOMT 07	22	25	34	166	88	56			
U420	●	24 D4 SOMT 08	24	25	34	174	96	56	SOMT 08T3 TGTC	TC063 M2,5x7	T8
U422	●	25 D4 SOMT 08	25	25	34	178	100	56			

U11
D2-D3 XCMT-QCMT

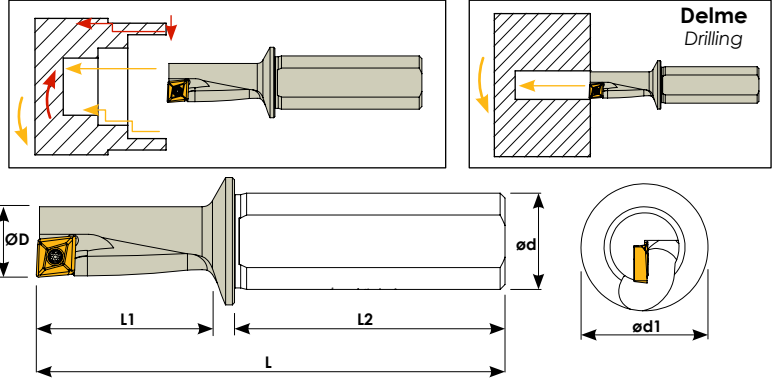

Sipariş Kodu Order Code Best.-Nr.	Stok/Stock/Lager	Ürün Kodu Product Code Produkt-Code	Ölçüler (mm) Dimensions(mm) Abmessungen (mm)						Kullanılan Uç Insert WSP	Sıkma Cıvatası Clamp Screw Torx-Schraube	Anahtar Torx Key Torx-Schlüssel
			D	d	d1	L	L1	L2			
U030	●	10 D2,25 QC-- 050204	10	12	16	74,5	22,5	42	QC-- 050204 KRLY	TC058 M2x4,2	T6
U032	●	12 D2,25 QC-- 060204	12	16	20	85	27	45	QC-- 060204 KRLY	TC059 M2,2x5	T7
U034	●	14 D2,25 QC-- 070304	14	16	20	90	31,5	45	QC-- 070304 KRLY	TC060 M2,5x5,5	T8
U036	●	16 D2,25 QC-- 080304	16	20	25	100	36	50	QC-- 080304 KRLY	TC065 M3x7	
U040	●	20 D2,25 QC-- 10T304	20	25	31	116	45	56	QC-- 10T304 KRLY	TC067 M3,5x9	T15
U042	●	25 D2,25 QC-- 130404	25	32	39	135	56,5	60	QC-- 130404 KRLY	TC080 M4,5x11	
U038	●	18 D2,25 QC-- 09T304	18	25	31	112	40,5	56	XCMT 09T304 ISCR	TC065 M3x7	T8

KRLY ucuna uygundur. / Compatible with KRLY insert. / Kompatible für KRLY WP
QC-- 09T304 ucuna uygundur. / QC-- 09T304 compatible with ISCR insert. / QC-- 09T304 kompatible für ISCR WP

Sipariş Kodu Order Code Best.-Nr.	Stok/Stock/Lager	Ürün Kodu Product Code Produkt-Code	Ölçüler (mm) Dimensions(mm) Abmessungen (mm)						Kullanılan Uç Insert WSP	Sıkma Cıvatası Clamp Screw Torx-Schraube	Anahtar Torx Key Torx-Schlüssel
			D	d	d1	L	L1	L2			
U08	●	8 D2 XC-- 040104	8	12	16	68	18	42	XCMT 040104 TGTC	TC051 M1,8	T6
U12	●	10 D3 XC-- 050204	10	16	25	90	30	45	XCMT 050204 TGTC	TC058 M2x4,5	
U14	●	10,5 D3 XC-- 050204	10,5	16	25	90	31	45	XCMT 060204 TGTC	TC059 M2,2x5	T7
U18	●	11,5 D3 XC-- 060204	11,5	16	25	92	35	45			
U20	●	12 D3 XC-- 060204	12	16	25	94	36	45			

TGTC ucuna uygundur. / Compatible with TGTCinsert. / Kompatible für TGTCWP

Alüminyum için/For Aluminum/ Für Aluminium

Sipariş Kodu Order Code Best.-Nr.	Stok/Stock/Lager	Ürün Kodu Product Code Produkt-Code	Ölçüler (mm) Dimensions(mm) Abmessungen (mm)						Kullanılan Uç Insert WSP	Sıkma Cıvatası Clamp Screw Torx-Schraube	Anahtar Torx Key Torx-Schlüssel
			D	d	d1	L	L1	L2			
U32	●	10,5 D3 XC-- 050204	10,5	16	25	90	31	45	XCMT 050204 TGTC	TC058 M2x4,2	T6
U34	●	11 D3 XC-- 050204	11	16	25	92	33	45	XCMT 060204 TGTC	TC059 M2,2x5	T7
U36	●	11,5 D3 XC-- 060204	11,5	16	25	92	35	45			

TGTC ucuna uygundur. / Compatible with TGTCinsert. / Kompatible für TGTCWP



Kanal Kater
Grooving Holders
Stech-Klemmhalter

D1 KRLY-R

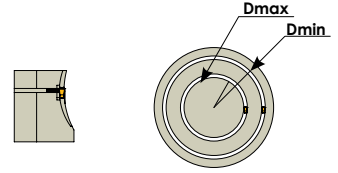
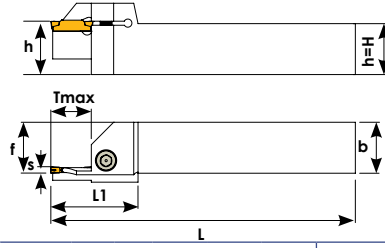

Sipariş Kodu Order Code Best.-Nr.	Stok/Stock/Lager	Ürün Kodu Product Code Produkt-Code	Ölçüler (mm) Dimensions(mm) Abmessungen (mm)									Kullanılan Uç Insert WSP	Sıkma Cıvatası Clamp Screw Inbuss-Schraube	Anahtar Allen Key Inbuss-Schlüssel				
			Dmin	Dmax	S	Tmax	f	b	h=H	L	L1							
D780	●	2525 3C-R (50-60)	50	60	3	17	25	25	25	150	40	MGM 3 KRLY	TC134 M6x20	5 Allen				
D782	●	2525 3C-R (60-80)	60	80	3	17	25	25	25	150	40							
D784	●	2525 3C-R (80-110)	80	110	3	17	25	25	25	150	40							
D785	●	2525 3C-R (110-150)	110	150	3	17	25	25	25	150	40							
D786	●	2525 4C-R (50-60)	50	60	4	20	25	25	25	150	45	MGM 4 KRLY			TC134 M6x20	5 Allen		
D788	●	2525 4C-R (60-80)	60	80	4	20	25	25	25	150	45							
D790	●	2525 4C-R (80-110)	80	110	4	20	25	25	25	150	45							
D791	●	2525 4C-R (110-150)	110	150	4	20	25	25	25	150	45							
D791-1	●	2525 4C (140-600)	140	600	4	25	25	25	25	150	49	MGM 5 KRLY					TC134 M6x20	5 Allen
D792	●	2525 5C-R (50-80)	50	80	5	20	25	25	25	150	45							
D796	●	2525 5C-R (80-110)	80	110	5	20	25	25	25	150	45							
D798	●	2525 5C-R (110-150)	110	150	5	20	25	25	25	150	45							
D799	●	2525 5C-R (140-350)	140	350	5	20	25	25	25	150	45	MGM 5 KRLY	TC134 M6x20	5 Allen				
D799-1	●	2525 5C-R (350-500)	350	500	5	20	25	25	25	150	45							
D799-2	●	2525 5C-R (140-600)	140	600	5	25	25	25	25	150	49							

D1 KRLY-L

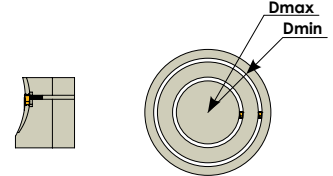
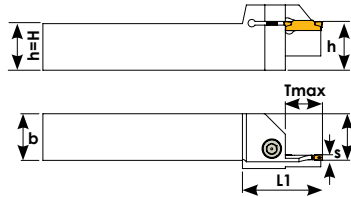

Sipariş Kodu Order Code Best.-Nr.	Stok/Stock/Lager	Ürün Kodu Product Code Produkt-Code	Ölçüler (mm) Dimensions(mm) Abmessungen (mm)									Kullanılan Uç Insert WSP	Sıkma Cıvatası Clamp Screw Inbuss-Schraube	Anahtar Allen Key Inbuss-Schlüssel				
			Dmin	Dmax	S	Tmax	f	b	h=H	L	L1							
D800	●	2525 3C-L (50-60)	50	60	3	17	25	25	25	150	40	MGM 3 KRLY	TC134 M6x20	5 Allen				
D802	●	2525 3C-L (60-80)	60	80	3	17	25	25	25	150	40							
D804	●	2525 3C-L (80-110)	80	110	3	17	25	25	25	150	40							
D805	●	2525 3C-L (110-150)	110	150	3	17	25	25	25	150	40							
D806	●	2525 4C-L (50-60)	50	60	4	20	25	25	25	150	45	MGM 4 KRLY			TC134 M6x20	5 Allen		
D808	●	2525 4C-L (60-80)	60	80	4	20	25	25	25	150	45							
D810	●	2525 4C-L (80-110)	80	110	4	20	25	25	25	150	45							
D811	●	2525 4C-L (110-150)	110	150	4	20	25	25	25	150	45							
D811-1	●	2525 4C-L (140-600)	140	600	4	25	25	25	25	150	49	MGM 5 KRLY					TC134 M6x20	5 Allen
D812	●	2525 5C-L (50-80)	50	80	5	20	25	25	25	150	45							
D816	●	2525 5C-L (80-110)	80	110	5	20	25	25	25	150	45							
D818	●	2525 5C-L (110-150)	110	150	5	20	25	25	25	150	45							
D819	●	2525 5C-L (140-600)	140	600	5	25	25	25	25	150	49	MGM 5 KRLY	TC134 M6x20	5 Allen				
D819-1	●	2525 5C-L (350-500)	350	500	5	20	25	25	25	150	45							

KRLY ucuna uygundur. / Compatible with KRLY insert. / Kompatible für KRLY WP

**D2
MGM /R**

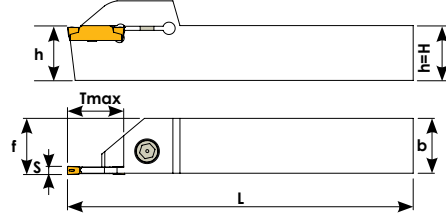

Sipariş Kodu Order Code Best.-Nr.	Stok/Stock/Lager	Ürün Kodu Product Code Produkt-Code	Ölçüler (mm) Dimensions(mm) Abmessungen (mm)						Kullanılan Uç Insert WSP	Sıkma Civatası Clamp Screw Inbuss-Schraube	Anahtar Allen Key Inbuss-Schlüssel
			h=H	b	S	Tmax	f	L			
D658	●	1212 2C-R MGM	12	12	2	16	12	125	2C MGM KRLY	TC132 M5x20	4 Allen
D660	●	1616 2C-R MGM	16	16	2	16	16	125			
D662	●	2020 2C-R MGM	20	20	2	16	20	125			
D664	●	2525 2C-R MGM	25	25	2	16	25	150			
D666	●	3232 2C-R MGM	32	32	2	16	32	170	3C MGM KRLY	TC132 M5x20	4 Allen
D667	●	1212 3C-R MGM	12	12	3	18	12	125			
D668	●	1616 3C-R MGM	16	16	3	18	16	125			
D670	●	2020 3C-R MGM	20	20	3	18	20	125			
D672	●	2525 3C-R MGM	25	25	3	18	25	150	4C MGM KRLY	TC134 M6x20	5 Allen
D674	●	3232 3C-R MGM	32	32	3	20	32	170			
D675	●	1616 4C-R MGM	16	16	4	18	16	125			
D676	●	2020 4C-R MGM	20	20	4	18	20	125			
D678	●	2525 4C-R MGM	25	25	4	18	25	150	5C MGM KRLY	TC132 M5x20	4 Allen
D680	●	3232 4C-R MGM	32	32	4	20	32	170			
D682	●	2020 5C-R MGM	20	20	5	25	20	125			
D684	●	2525 5C-R MGM	25	25	5	25	25	150			
D686	●	3232 5C-R MGM	32	32	5	25	32	170	6C MGM KRLY	TC134 M6x20	5 Allen
D687	●	2525 6C-R MGM	25	25	6	27	25	150			

KRLY ucuna uygundur. / Compatible with KRLY insert. / Kompatible für KRLY WP

**D2
MGM /R**

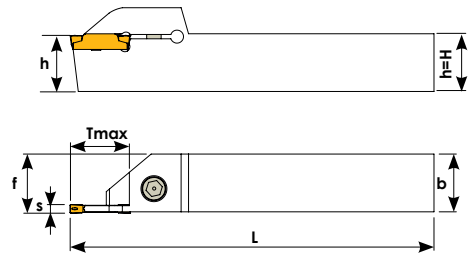

Sipariş Kodu Order Code Best.-Nr.	Stok/Stock/Lager	Ürün Kodu Product Code Produkt-Code	Ölçüler (mm) Dimensions(mm) Abmessungen (mm)						Kullanılan Uç Insert WSP	Sıkma Civatası Clamp Screw Inbuss-Schraube	Anahtar Allen Key Inbuss-Schlüssel
			h	b	S	Tmax	f	L			
D960	●	2525 3C-R MGM	25	25	3	25	25	150	3C MGM KRLY	TC134 M6x20	5 Allen
D963	●	2525 3C-R MGM	25	25	3	40	25	170			
D961	●	2525 4C-R MGM	25	25	4	25	25	150	4C MGM KRLY		
D964	●	2525 4C-R MGM	25	25	4	40	25	170			
D962	●	2525 5C-R MGM	25	25	5	40	25	170	5C MGM KRLY		

KRLY ucuna uygundur. / Compatible with KRLY insert. / Kompatible für KRLY WP

D3 MGM /L

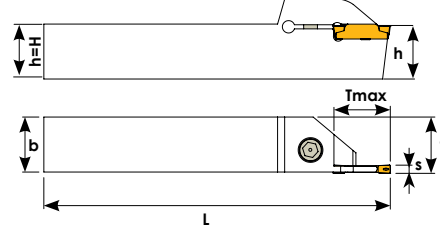

Sipariş Kodu Order Code Best.-Nr.	Stok/Stock/Lager	Ürün Kodu Product Code Produkt-Code	Ölçüler (mm) Dimensions(mm) Abmessungen (mm)						Kullanılan Uç Insert WSP	Sıkma Cıvatası Clamp Screw Inbuss-Schraube	Anahtar Allen Key Inbuss-Schlüssel
			h=H	b	S	Tmax	f	L			
D607	●	1212 2C-L MGM	12	12	2	16	12	125	2C MGM KRLY	TC132 M5x20	4 Allen
D608	●	1616 2C-L MGM	16	16	2	16	16	125			
D610	●	2020 2C-L MGM	20	20	2	16	20	125			
D611	●	2525 2C-L MGM	25	25	2	16	25	150			
D612	●	1616 3C-L MGM	16	16	3	18	16	125	3C MGM KRLY	TC134 M6x20	5 Allen
D614	●	2020 3C-L MGM	20	20	3	18	20	125			
D615	●	2525 3C-L MGM	25	25	3	18	25	150			
D617	●	2020 4C-L MGM	20	20	4	18	20	125	4C MGM KRLY	TC132 M5x20	4 Allen
D618	●	2525 4C-L MGM	25	25	4	18	25	150	5C MGM KRLY	TC134 M6x20	5 Allen
D620	●	2525 5C-L MGM	25	25	5	25	25	150			
D621	●	2525 6C-L MGM	25	25	5	27	25	150	6C MGM KRLY		

KRLY ucuna uygundur. / Compatible with KRLY insert. / Kompatible für KRLY WP

D4 GRP /R

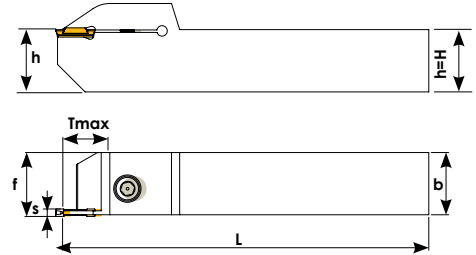

Sipariş Kodu Order Code Best.-Nr.	Stok/Stock/Lager	Ürün Kodu Product Code Produkt-Code	Ölçüler (mm) Dimensions(mm) Abmessungen (mm)						Kullanılan Uç Insert WSP	Sıkma Cıvatası Clamp Screw Inbuss-Schraube	Anahtar Allen Key Inbuss-Schlüssel
			h=H	b	S	Tmax	f	L			
D773	●	2020 3C-R GRP	20	20	3	18	20	125	3C GRP ISCR	TC132 M5x20	4 Allen
D769	●	2525 3C-R GRP	25	25	3	18	25	150			
D770	●	2525 4C-R GRP	25	25	4	20	25	150	4C GRP ISCR	TC134 M6x20	5 Allen
D772	●	3232 4C-R GRP	32	32	4	18	32	170			
D771	●	2525 5C-R GRP	25	25	5	24	25	150			
D774	●	3232 5C-R GRP	32	32	5	24	32	170	5C GRP ISCR		

ISCR ucuna uygundur. / Compatible with ISCR insert. / Kompatible für ISCR WP

D5
KGMN /R

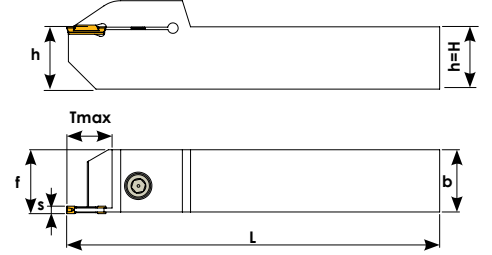

Sipariş Kodu Order Code Best.-Nr.	Stok/Stock/Lager	Ürün Kodu Product Code Produkt-Code	Ölçüler (mm) Dimensions(mm) Abmessungen (mm)						Kullanılan Uç Insert WSP	Sıkma Civatası Clamp Screw Inbuss-Schraube	Anahtar Allen Key Inbuss-Schlüssel
			h=H	b	S	Tmax	f	L			
D635	●	2020 2C-R KGMN	20	20	2	18	20	125	2C KGMN KRLY	TC132 M5x20	4 Allen
D636	●	2525 2C-R KGMN	25	25	2	18	25	150		TC134 M6x20	5 Allen
D637	●	2020 3C-R KGMN	20	20	3	20	20	125	3C KGMN KRLY	TC132 M5x20	4 Allen
D638	●	2525 3C-R KGMN	25	25	3	22	25	150		TC134 M6x20	5 Allen
D639	●	2020 4C-R KGMN	20	20	4	20	20	125	4C KGMN KRLY	TC132 M5x20	4 Allen
D640	●	2525 4C-R KGMN	25	25	4	22	25	152		TC134 M6x20	5 Allen

KRLY ucuna uygundur. / Compatible with KRLY insert. / Kompatible für KRLY WP



D6 ISCR /R

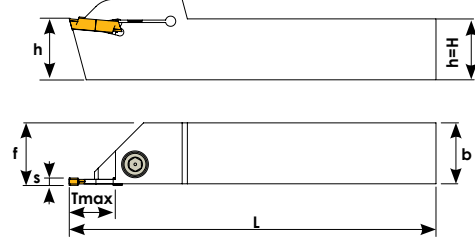

Sipariş Kodu Order Code Best.-Nr.	Stok/Stock/Lager	Ürün Kodu Product Code Produkt-Code	Ölçüler (mm) Dimensions (mm) Abmessungen (mm)						Kullanılan Uç Insert WSP	Sıkma Civatası Clamp Screw Inbuss-Schraube	Anahtar Allen Key Inbuss-Schlüssel
			h=H	b	S	Tmax	f	L			
D750	●	1212 2C-R DGN	12	12	2	16	12	125	2C DGN ISCR	TC132 M5x20	4 Allen
D752	●	1616 2C-R DGN	16	16	2	16	16	125			
D754	●	2020 2C-R DGN	20	20	2	18	20	125		TC134 M6x20	5 Allen
D756	●	2525 2C-R DGN	25	25	2	19	25	150	3C DGN ISCR	TC132 M5x20	4 Allen
D758	●	1212 3C-R DGN	12	12	3	16	12	125			
D760	●	1616 3C-R DGN	16	16	3	19	16	125		TC134 M6x20	5 Allen
D762	●	2020 3C-R DGN	20	20	3	20	20	125	4C DGN ISCR	TC132 M5x20	4 Allen
D764	●	2525 3C-R DGN	25	25	3	22	25	150			
D775	●	2020 4C-R DGN	20	20	4	20	20	125		TC134 M6x20	5 Allen
D777	●	2525 4C-R DGN	25	25	4	20	25	150			

ISCR ucuna uygundur. / Compatible with ISCR insert. / Kompatible für ISCR WP

D6 ISCR /L

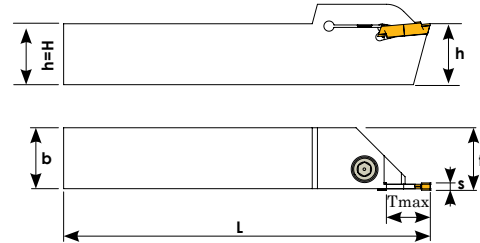

Sipariş Kodu Order Code Best.-Nr.	Stok/Stock/Lager	Ürün Kodu Product Code Produkt-Code	Ölçüler (mm) Dimensions (mm) Abmessungen (mm)						Kullanılan Uç Insert WSP	Sıkma Civatası Clamp Screw Inbuss-Schraube	Anahtar Allen Key Inbuss-Schlüssel
			h=H	b	S	Tmax	f	L			
D726	●	1212 2C-L DGN	12	12	2	16	12	125	2C DGN ISCR	TC132 M5x20	4 Allen
D727	●	1616 2C-L DGN	16	16	2	16	16	125			
D728	●	2020 2C-L DGN	20	20	2	18	20	125			
D729	●	2525 2C-L DGN	25	25	2	19	25	150	3C DGN ISCR	TC132 M5x20	4 Allen
D730	●	1212-3C-L DGN	12	12	3	16	12	125			
D731	●	1616 3C-L DGN	16	16	3	19	16	125			
D732	●	2020 3C-L DGN	20	20	3	20	20	125	4C DGN ISCR	TC132 M5x20	4 Allen
D733	●	2525 3C-L DGN	25	25	3	22	25	150			

ISCR ucuna uygundur. / Compatible with ISCR insert. / Kompatible für ISCR WP

D7
ZCC/R ZT-D

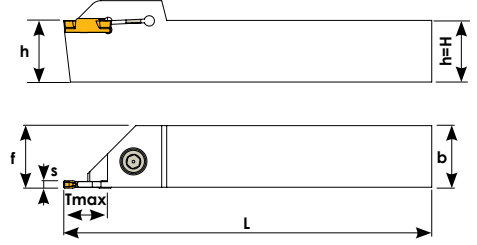

Sipariş Kodu Order Code Best.-Nr.	Stok/Stock/Lager	Ürün Kodu Product Code Produkt-Code	Ölçüler (mm) Dimensions(mm) Abmessungen (mm)						Kullanılan Uç Insert WSP	Sıkma Civatası Clamp Screw Inbuss-Schraube	Anahtar Allen Key Inbuss-Schlüssel
			h=H	b	S	Tmax	f	L			
D027	●	1616 3C-R ZT-D	16	16	3	18	16	125	3C ZT.D ZCC	TC132 M5x20	4 Allen
D028	●	2020 3C-R ZT-D	20	20	3	18	20	125			
D030	●	2525 3C-R ZT-D	25	25	3	22	25	150			
D036	●	2020 4C-R ZT-D	20	20	4	18	20	125	4C ZT.D ZCC	TC132 M5x20	4 Allen
D038	●	2525 4C-R ZT-D	25	25	4	22	25	150			
D044	●	2020 5C-R ZT-D	20	20	5	18	20	125	5C ZT.D ZCC	TC132 M5x20	4 Allen
D046	●	2525 5C-R ZT-D	25	25	5	18	25	150			
D049	●	2525 6C-R ZT-D	25	25	6	18	25	150	6C ZT.D ZCC	TC134 M6x20	5 Allen
D051	●	3232 6C-R ZT-D	32	32	6	20	32	170			

ZCC ucuna uygundur. / Compatible with ZCC insert. / Kompatible für ZCC WP

D8
TKT /R TD

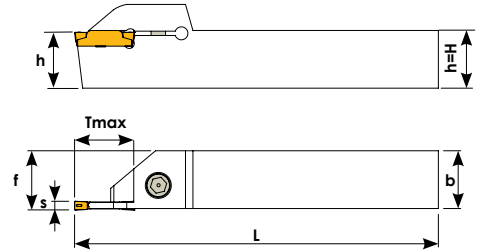

Sipariş Kodu Order Code Best.-Nr.	Stok/Stock/Lager	Ürün Kodu Product Code Produkt-Code	Ölçüler (mm) Dimensions(mm) Abmessungen (mm)						Kullanılan Uç Insert WSP	Sıkma Civatası Clamp Screw Inbuss-Schraube	Anahtar Allen Key Inbuss-Schlüssel
			h=H	b	S	Tmax	f	L			
D714	●	1212 2C-R TD	12	12	2	16	12	125	2C TD TGTC	TC132 M5x20	4 Allen
D715	●	1616 2C-R TD	16	16	2	16	16	125			
D716	●	2020 2C-R TD	20	20	2	16	20	125			
D717	●	2525 2C-R TD	25	25	2	18	25	150	3C TD TGTC	TC134 M6x20	5 Allen
D718	●	1212 3C-R TD	12	12	2	16	12	125			
D719	●	1616 3C-R TD	16	16	3	18	16	125	4C TD TGTC	TC132 M5x20	4 Allen
D720	●	2020 3C-R TD	20	20	3	18	20	125			
D721	●	2525 3C-R TD	25	25	3	18	25	150			
D722	●	2020 4C-R TD	20	20	4	18	20	125	TC134 M6x20	5 Allen	
D723	●	2525 4C-R TD	25	25	4	18	25	150			

TGTCucuna uygundur. / Compatible with TGTCinsert. / Kompatible für TGTCWP

D9

K-HRN/R S224

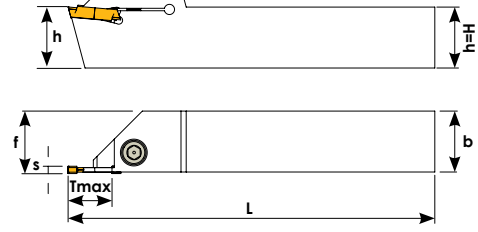

Sipariş Kodu Order Code Best.-Nr.	Stok/Stok/Lager	Ürün Kodu Product Code Produkt-Code	Ölçüler (mm) Dimensions (mm) Abmessungen (mm)						Kullanılan Uç Insert WSP	Sıkma Cıvatası Clamp Screw Inbuss-Schraube	Anahtar Allen Key Inbuss-Schlüssel
			h=H	b	S	Tmax	f	L			
D700	●	1616 2C-R S224	16	16	2	18	16	125	2C S224 K-HRN	TC132 M5x20	4 Allen
D701	●	2020 2C-R S224	20	20	2	18	20	125		TC134 M6x20	5 Allen
D702	●	2525 2C-R S224	25	25	2	18	25	150	3C S224 K-HRN	TC132 M5x20	4 Allen
D703	●	1616 3C-R S224	16	16	3	18	16	100		TC134 M6x20	5 Allen
D704	●	2020 3C-R S224	20	20	3	18	20	125	4C S224 K-HRN	TC132 M5x20	4 Allen
D705	●	2525 3C-R S224	25	25	3	18	25	150		TC134 M6x20	5 Allen
D706	●	2020 4C-R S224	20	20	4	18	20	125	5C S224 K-HRN	TC132 M5x20	4 Allen
D707	●	2525 4C-R S224	25	25	4	18	25	150		TC134 M6x20	5 Allen
D708	●	2020 5C-R S224	20	20	5	18	20	125	5C S224 K-HRN	TC132 M5x20	4 Allen
D710	●	2525 5C-R S224	25	25	5	18	25	150		TC134 M6x20	5 Allen

HRN ucuna uygundur. / Compatible with HRN insert. / Kompatible für HRN WP



D10

B-HRN/R S229

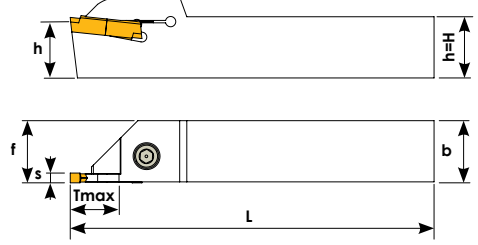

Sipariş Kodu Order Code Best.-Nr.	Stok/Stock/Lager	Ürün Kodu Product Code Produkt-Code	Ölçüler (mm) Dimensions(mm) Abmessungen (mm)						Kullanılan Uç Insert WSP	Sıkma Civatası Clamp Screw Inbuss-Schraube	Anahtar Allen Key Inbuss-Schlüssel
			h=H	b	S	Tmax	f	L			
D688	●	2020 3C-R S229	20	20	3	22	20	125	3C S229 B-HRN	TC132 M5x20	4 Allen
D690	●	2525 3C-R S229	25	25	3	22	25	150		TC134 M6x20	5 Allen
D692	●	2020 4C-R S229	20	20	4	22	20	125	4C S229 B-HRN	TC132 M5x20	4 Allen
D694	●	2525 4C-R S229	25	25	4	22	25	150		TC134 M6x20	5 Allen
D696	●	2020 5C-R S229	20	20	5	22	20	125	5C S229 B-HRN	TC132 M5x20	4 Allen
D698	●	2525 5C-R S229	25	25	5	22	25	150		TC134 M6x20	5 Allen

HRN ucuna uygundur. / Compatible with HRN insert. / Kompatible für HRN WP

D10

B-HRN/L S229

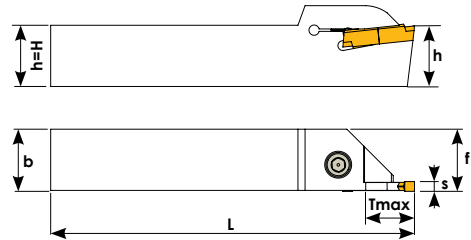

Sipariş Kodu Order Code Best.-Nr.	Stok/Stock/Lager	Ürün Kodu Product Code Produkt-Code	Ölçüler (mm) Dimensions(mm) Abmessungen (mm)						Kullanılan Uç Insert WSP	Sıkma Civatası Clamp Screw Inbuss-Schraube	Anahtar Allen Key Inbuss-Schlüssel
			h=H	b	S	Tmax	f	L			
D711	●	2525 3C-L S229	25	25	3	22	25	150	3C S229 B-HRN	TC134 M6x20	5 Allen
D712	●	2525 4C-L S229	25	25	4	22	25	150			
D713	●	2525 5C-L S229	25	25	5	22	25	150			

HRN ucuna uygundur. / Compatible with HRN insert. / Kompatible für HRN WP

D11 SDV 123-R

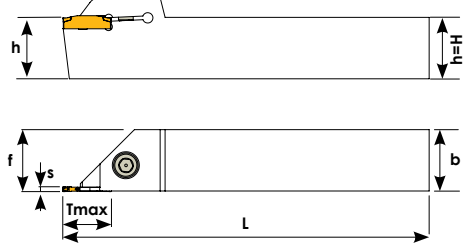

Sipariş Kodu Order Code Best.-Nr.	Stok/Stock/Lager	Ürün Kodu Product Code Produkt-Code	Ölçüler (mm) Dimensions(mm) Abmessungen (mm)						Kullanılan Uç Insert WSP	Sıkma Civatası Clamp Screw Inbuss-Schraube	Anahtar Allen Key Inbuss-Schlüssel
			h=H	b	S	Tmax	f	L			
D900	●	2020 2C-123 SDV-R	20	20	2	18	20	125	2C 123 SDV	TC132 M5x20	4 Allen
D902	●	2525 2C-123 SDV-R	25	25	2	18	25	150		TC134 M6x20	5 Allen
D904	●	2020 3C-123 SDV-R	20	20	3	19	20	125	3C 123 SDV	TC132 M5x20	4 Allen
D906	●	2525 3C-123 SDV-R	25	25	3	20	25	150		TC134 M6x20	5 Allen
D908	●	2020 4C-123 SDV-R	20	20	4	18	20	125	4C 123 SDV	TC132 M5x20	4 Allen
D910	●	2525 4C-123 SDV-R	25	25	4	18	25	150		TC134 M6x20	5 Allen
D912	●	2525 5C-123 SDV-R	25	25	5	18	25	150	5C 123 SDV	TC134 M6x20	5 Allen

D11 SDV 123-L

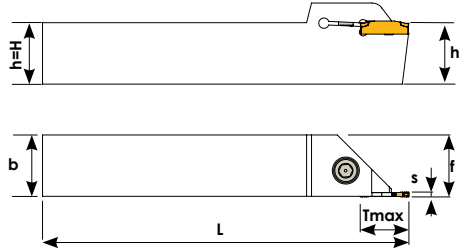

Sipariş Kodu Order Code Best.-Nr.	Stok/Stock/Lager	Ürün Kodu Product Code Produkt-Code	Ölçüler (mm) Dimensions(mm) Abmessungen (mm)						Kullanılan Uç Insert WSP	Sıkma Civatası Clamp Screw Inbuss-Schraube	Anahtar Allen Key Inbuss-Schlüssel
			h=H	b	S	Tmax	f	L			
D873	○	2020 2C-123 SDV-L	20	20	2	18	20	125	2C 123 SDV	TC132 M5x20	4 Allen
D874	○	2525 2C-123 SDV-L	25	25	2	18	25	150		TC134 M6x20	5 Allen
D875	○	2020 3C-123 SDV-L	20	20	3	19	20	125	3C 123 SDV	TC132 M5x20	4 Allen
D876	○	2525 3C-123 SDV-L	25	25	3	20	25	150		TC134 M6x20	5 Allen
D877	○	2020 4C-123 SDV-L	20	20	4	18	20	125	4C 123 SDV	TC132 M5x20	4 Allen
D878	○	2525 4C-123 SDV-L	25	25	4	18	25	150		TC134 M6x20	5 Allen
D879	○	2525 5C-123 SDV-L	25	25	5	18	25	150	5C 123 SDV	TC134 M6x20	5 Allen

SNDVK ucuna uygundur. / Compatible with SNDVK insert. / Kompatibel für SNDVK WP



İç Çap Kanal Kater
Grooving Holders
Stech-Klemmhalter

K1
KRLY/R

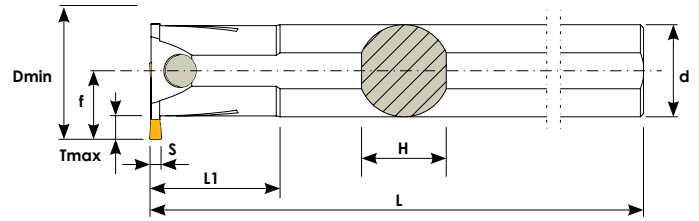
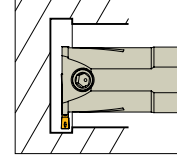

Sipariş Kodu Order Code Best.-Nr.	Stok/Stock/Lager	Ürün Kodu Product Code Produkt-Code	Ölçüler (mm) Dimensions(mm) Abmessungen (mm)								Kullanılan Uç Insert WSP	Sıkma Cıvatası Clamp Screw Inbuss-Schraube	Anahtar Allen Key Inbuss-Schlüssel
			Dmin	Tmax	L	L1	d	h	f	s			
K600	●	S16Q 2C-R MGM	21	5	180	35	16	15	12.5	2	2C MGM KRLY	TC130 M5x12	4 Allen
K602	●	S20Q 2C-R MGM	26	5,7	180	35	20	18	15.5	2		TC132 M5x20	
K603	●	S25R 2C-R MGM	31	5,7	200	35	25	23	18	2			
K604	●	S20Q 3C-R MGM	26	6	180	35	20	18	15,5	3	3C MGM KRLY	TC134 M6x20	5 Allen
K606	●	S25R 3C-R MGM	32	6,7	200	40	25	23	19	3			
K608	●	S32S 3C-R MGM	38	6,1	250	60	32	30	21.5	3			
K609	●	S40T 3C-R MGM	48	7,2	300	60	40	38	27	3	4C MGM KRLY	TC132 M5x20	4 Allen
K610	●	S20Q 4C-R MGM	26	6	180	35	20	18	15.5	4			
K612	●	S25R 4C-R MGM	31	6	200	40	25	23	18,2	4			
K614	●	S32S 4C-R MGM	38	6	250	60	32	30	21,5	4			
K616	●	S40T 4C-R MGM	47	7,2	300	60	40	38	27	4	5C MGM KRLY	TC132 M5x20	4 Allen
K618	●	S25R 5C-R MGM	32	7	200	40	25	23	19,2	5			
K620	●	S32S 5C-R MGM	39	7	250	60	32	30	22,5	5			
K622	●	S40T 5C-R MGM	47	7,4	300	60	40	38	27	5	TC134 M6x20	5 Allen	

KRLY ucuna uygundur. / Compatible with KRLY insert. / Kompatible für KRLY WP

K2
HRN/R S229

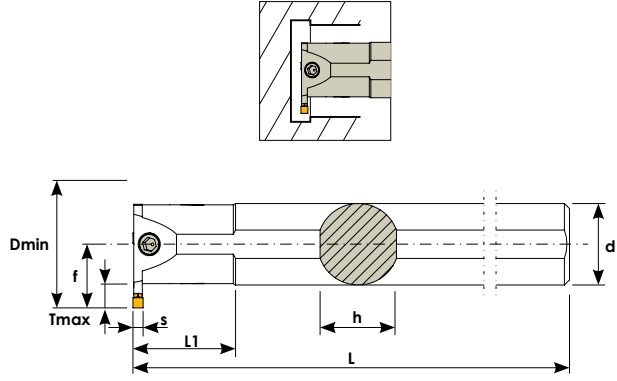

Sipariş Kodu Order Code Best.-Nr.	Stok/Stock/Lager	Ürün Kodu Product Code Produkt-Code	Ölçüler (mm) Dimensions (mm) Abmessungen (mm)								Kullanılan Uç Insert WSP	Sıkma Civatası Clamp Screw Inbuss-Schraube	Anahtar Allen Key Inbuss-Schlüssel
			Dmin	Tmax	L	L1	d	h	f	s			
K624	●	S25R 3C-R S229	34	9.8	200	50	25	23	21,5	3	3C S229 B.HRN	TC132 M5x20	4 Allen
K626	●	S32S 3C-R S229	41	9	250	50	32	30	24,5	3		TC134 M6x20	5 Allen
K628	●	S40T 3C-R S229	49	9	300	50	40	38	28,5	3			
K630	●	S25R 4C-R S229	34	9,8	200	50	25	23	21,5	4	4C S229 B.HRN	TC132 M5x20	4 Allen
K632	●	S32S 4C-R S229	42	9	250	50	32	30	24,7	4		TC134 M6x20	5 Allen
K634	●	S40T 4C-R S229	49	9	300	50	40	38	28,5	4			
K636	●	S25R 5C-R S229	33	9,35	200	50	25	23	21,1	5	5C S229 B.HRN	TC132 M5x20	4 Allen
K638	●	S32S 5C-R S229	41	9	250	50	32	30	24,7	5		TC134 M6x20	5 Allen
K640	●	S40T 5C-R S229	49	9	300	50	40	38	28,5	5			

HRN ucuna uygundur. / Compatible with HRN insert. / Kompatibel für HRN WP

K3
SDV/R 123

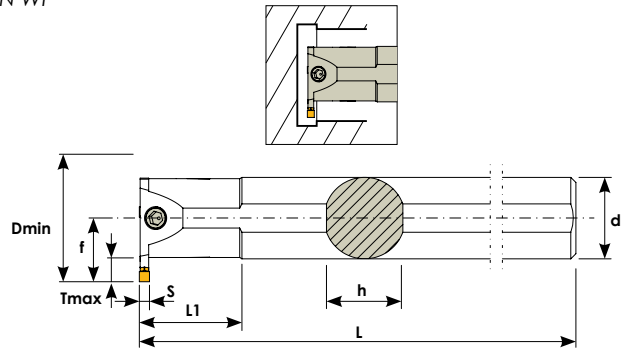

Sipariş Kodu Order Code Best.-Nr.	Stok/Stock/Lager	Ürün Kodu Product Code Produkt-Code	Ölçüler (mm) Dimensions (mm) Abmessungen (mm)								Kullanılan Uç Insert WSP	Sıkma Civatası Clamp Screw Inbuss-Schraube	Anahtar Allen Key Inbuss-Schlüssel
			Dmin	Tmax	L	L1	d	h	f	s			
K720	●	S25R 3C-R-123 SDV	32	7	200	40	25	23	19,2	3	3C 123 SNDVK	TC132 M5x20	4 Allen
K722	●	S32S 3C-R-123 SDV	39	7	250	60	32	30	22,7	3		TC134 M6x20	5 Allen
K726	●	S25R 4C-R-123 SDV	32	7	200	40	25	23	19,5	4	4C 123 SNDVK	TC132 M5x20	4 Allen
K728	●	S32S 4C-R-123 SDV	39	7	250	60	32	30	22,5	4		TC134 M6x20	5 Allen
K730	●	S25S 5C-R-123 SDV	32	7	200	40	25	23	19,2	5	5C 123 SNDVK	TC132 M5x20	4 Allen
K732	●	S32S 5C-R-123 SDV	39	7	250	60	32	30	22,7	5		TC134 M6x20	5 Allen

SNDVK ucuna uygundur. / Compatible with SNDVK insert. / Kompatibel für SNDVK WP

K4 HRN/R S224

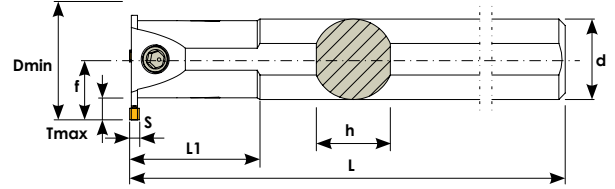
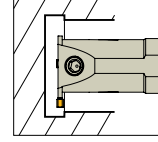

Sipariş Kodu Order Code Best.-Nr.	Stok/Stock/Lager	Ürün Kodu Product Code Produkt-Code	Ölçüler (mm) Dimensions(mm) Abmessungen (mm)								Kullanılan Uç Insert WSP	Sıkma Cıvatası Clamp Screw Inbuss-Schraube	Anahtar Allen Key Inbuss-Schlüssel
			Dmin	Tmax	L	L1	d	h	f	S			
K642	●	S20Q 2C-R S224	26	6,5	180	40	20	18	16	2	2C S224 K.HRN	TC132 M5x20	4 Allen
K644	●	S25R 2C-R S224	34	9	200	50	25	23	21,2	2			
K646	●	S20Q 3C-R S224	26	6,5	180	40	20	18	16	3	3C S224 K.HRN	TC134 M6x20	5 Allen
K648	●	S25R 3C-R S224	33	9	200	50	25	23	20,6	3			
K650	●	S32S 3C-R S224	40	9	250	50	32	30	24,1	3	4C S224 K.HRN	TC132 M5x20	4 Allen
K652	●	S20Q 4C-R S224	26	6,5	180	40	20	18	16	4			
K654	●	S25R 4C-R S224	33	9	200	50	25	23	20,6	4	TC134 M6x20	5 Allen	
K656	●	S32S 4C-R S224	42	9	250	50	32	30	23,5	4			

HRN ucuna uygundur. / Compatible with HRN insert. / Kompatible für HRN WP

K5 ZCC/R ZT.D

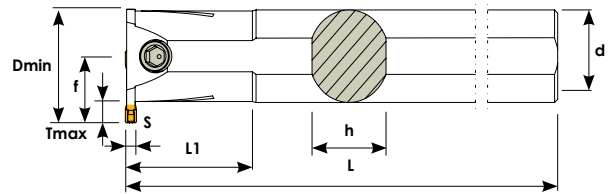
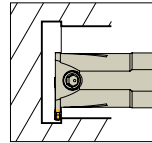

Sipariş Kodu Order Code Best.-Nr.	Stok/Stock/Lager	Ürün Kodu Product Code Produkt-Code	Ölçüler (mm) Dimensions(mm) Abmessungen (mm)								Kullanılan Uç Insert WSP	Sıkma Cıvatası Clamp Screw Inbuss-Schraube	Anahtar Allen Key Inbuss-Schlüssel
			Dmin	Tmax	L	L1	d	h	f	S			
K679	●	S16Q 2C R ZT.D	20	4,9	180	35	16	15	12,5	2	2C ZT.D ZCC	TC132 M5x20	4 Allen
K680	●	S20Q 3C-R ZT.D	26	5,5	180	35	20	18	15,2	3			
K681	●	S25R 3C-R ZT.D	33	7,5	200	35	25	23	19,7	3	3C ZT.D ZCC	TC134 M6x20	5 Allen
K682	●	S32S 3C-R ZT.D	39	7	250	50	32	30	22,7	3			
K684	●	S25R 4C-R ZT.D	33	7,5	200	35	25	23	19,7	4	4C ZT.D ZCC	TC132 M5x20	4 Allen
K685	●	S32S 4C-R ZT.D	39	7	250	50	32	30	22,7	4			

ZCC ucuna uygundur. / Compatible with ZCC insert. / Kompatible für ZCC ZCC WP

**K6
GRP/R**

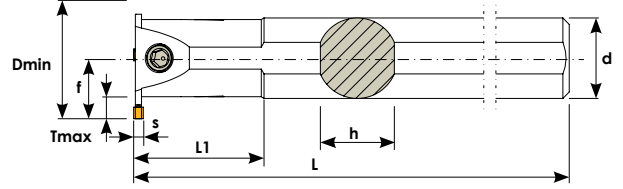
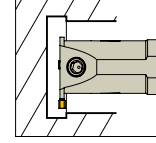

Sipariş Kodu Order Code Best.-Nr.	Stok/Stock/Lager	Ürün Kodu Product Code Produkt-Code	Ölçüler (mm) Dimensions(mm) Abmessungen (mm)								Kullanılan Uç Insert WSP	Sıkma Cıvatası Clamp Screw Inbuss-Schraube	Anahtar Allen Key Inbuss-Schlüssel
			Dmin	Tmax	L	L1	d	h	f	S			
K700	●	S16Q 3C-R GRP	21	4,9	180	45	16	18	12,5	3	3C GRP ISCR	TC130 M5x12	4 Allen
K702	●	S20Q 3C-R GRP	26	6	180	35	20	18	15,7	3			
K704	●	S25R 3C-R GRP	32	6,5	200	35	25	23	18,7	3		4C GRP ISCR	TC132 M5x20
K706	●	S20Q 4C-R GRP	26	5,5	180	35	20	18	15,2	4			
K708	●	S25R 4C-R GRP	32	6,5	200	35	25	23	18,7	4			
K710	●	S32S 4C-R GRP	38	6,5	250	60	32	30	22	4	TC134 M6x20		5 Allen

ISCR ucuna uygundur. / Compatible with ISCR insert. / Kompatible für ISCR WP

**K7
DGN/R**

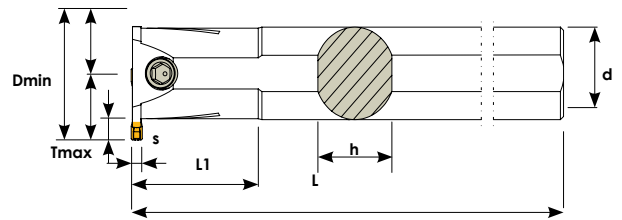
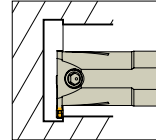

Sipariş Kodu Order Code Best.-Nr.	Stok/Stock/Lager	Ürün Kodu Product Code Produkt-Code	Ölçüler (mm) Dimensions(mm) Abmessungen (mm)								Kullanılan Uç Insert WSP	Sıkma Cıvatası Clamp Screw Inbuss-Schraube	Anahtar Allen Key Inbuss-Schlüssel
			Dmin	Tmax	L	L1	d	h	f	S			
K672	●	S20Q 3C-R DGN	25	5,5	180	35	20	18	15	3	3C DGN ISCR	TC132 M5x20	4 Allen
K673	●	S25R 3C-R DGN	31	6	200	40	25	23	18,2	3			
K674	●	S32S 3C-R DGN	37	6	250	55	32	30	30	3		4C DGN ISCR	TC134 M6x20
K676	●	S20Q 4C-R DGN	25	5,5	180	35	20	18	18	4			
K677	●	S25R 4C-R DGN	31	6	200	40	25	23	23	4			
K678	●	S32S 4C-R DGN	37	6	250	55	32	30	30	4	TC134 M6x20		5 Allen

ISCR ucuna uygundur. / Compatible with ISCR insert. / Kompatible für ISCR WP

M1

MİNİ KANAL KATERİ

Mini Grooving Holders

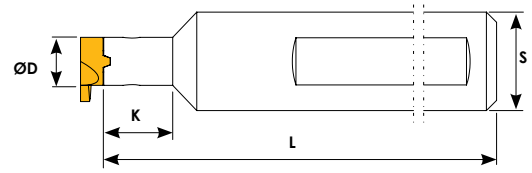

Sipariş Kodu Order Code Best.-Nr.	Stok/Stock/Lager	Ürün Kodu Product Code Produkt-Code	Ölçüler (mm) Dimensions(mm) Abmessungen (mm)				Kullanılan Uç Insert WSP	Sıkma Civatası Clamp Screw Torx-Schraube	Anahtar Torx Key Torx-Schlüssel
			S	D	K	L			
K810	●	S16 D08 K11 L94	16	8	11	93	D08	TC069 M3,5x8,5	T10
K812	●	S16 D09 K20 L94	16	9	20	93	D09	TC074 M4x10	T15
K814	●	S16 D06 K11 L78	16	6	11	78	D06	TC060 M2,5x5,5	T8
K816	●	S20 D14 K49 L160	20	14	49	160	D14	TC074 M4x10	T15

HRN ucuna uygundur. / Compatible with HRN insert. / Kompatible für HRN WP

M2

DIŞ AÇMA FREZELER

Thread Cutting Cutter

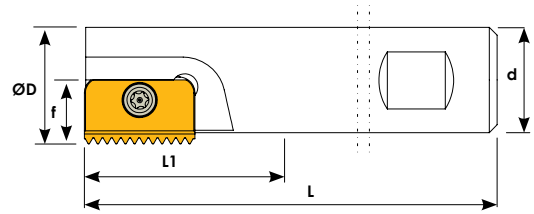

Sipariş Kodu Order Code Best.-Nr.	Stok/Stock/Lager	Ürün Kodu Product Code Produkt-Code	Ölçüler (mm) Dimensions(mm) Abmessungen (mm)						Kullanılan Uç Insert WSP	Sıkma Civatası Clamp Screw Torx-Schraube	Anahtar Torx Key Torx-Schlüssel
			D	Z	L	L1	d	f			
DAF02	●	D12 Z01 L100 C14	12	1	100	40	12	6	C 14 CPT	TC065 M3x7	T8
DAF04	●	D12 Z01 L080 C14	12	1	80	30	20	6			
DAF06	●	D15 Z01 L100 C14	15	1	100	-	12	7,5			
DAF10	●	D21 Z01 L100 C21	21	1	100	50	20	10,5	C 21 CPT	TC075 M4x11	T15
DAF12	●	D18 Z01 L120 C21	18	1	120	50	20	9			
DAF14	●	D29 Z01 L120 C21	29	1	120	50	32	14,5			
DAF16	●	D36 Z02 L120 C21	36	2	120	50	32	18			
DAF18	●	D25 Z01 L150 C21	25	1	150	40	20	12,5			

CPT ucuna uygundur. / Compatible with CPT insert. / Kompatible für CPT WP

KESKİ KÜTÜĞÜ
Block for Blades

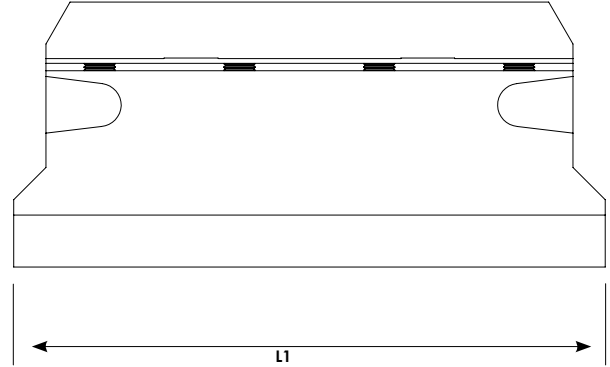
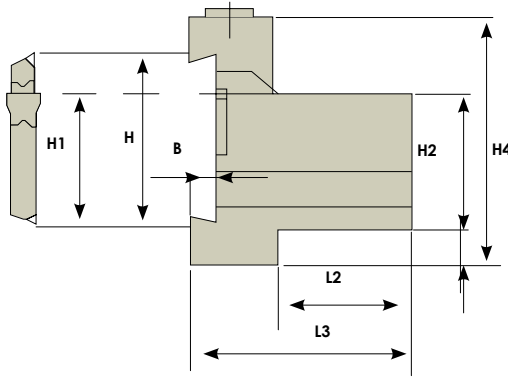

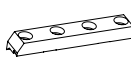
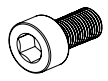
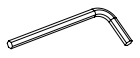
Sipariş Kodu Order Code Best.-Nr.	Stok/Stock/Lager	Ürün Kodu Product Code Produkt-Code	Ölçüler (mm) Dimensions (mm) Abmessungen (mm)								Papuç Clamp Spannpratze	Sıkma Civatası Clamp Screw Inbuss-Schraube	Anahtar Allen Key Inbuss-Schlüssel
			H	H1	H2	H4	B	L1	L2	L3			
KLT 06	●	20-32	32	24,8	20	48	5,5	100	19	35			
KLT 08	●	25-32	32	24,8	25	48	5,5	110	20	36			
KLT 10	●	32-32	32	24,8	32	48	5,5	120	28	44			



Takım Tutucuları

Tool Holders

Werkzeugaufnahmen



ISO 40

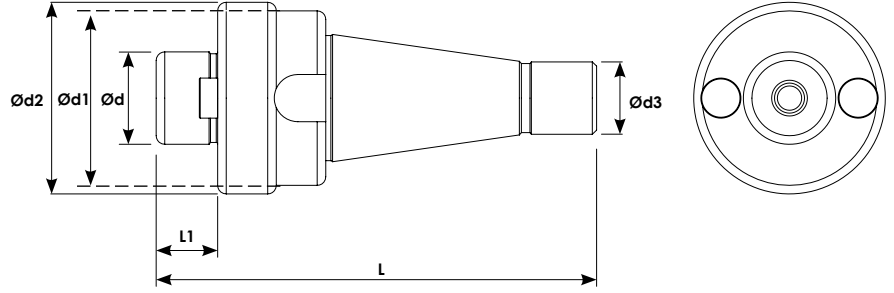

Sipariş Kodu Order Code Best.-Nr.	Stok/Stock/Lager	Ürün Kodu Product Code Produkt-Code	ŞAFT Shank Schaft	Ölçüler (mm) Dimensions (mm) Abmessungen (mm)					
				d	d1	d2	d3	L	L1
M206	●	ISO 40-16	ISO 40	16	54	38	25	154	17
M208	●	ISO 40-22	ISO 40	22	54	50	25	154	19
M210	●	ISO 40-27	ISO 40	27	55	59	25	154	21
M212	●	ISO 40-32	ISO 40	32	61	67	25	154	24
M214	●	ISO 40-40	ISO 40	40	61	73	25	154	27

ISO 50

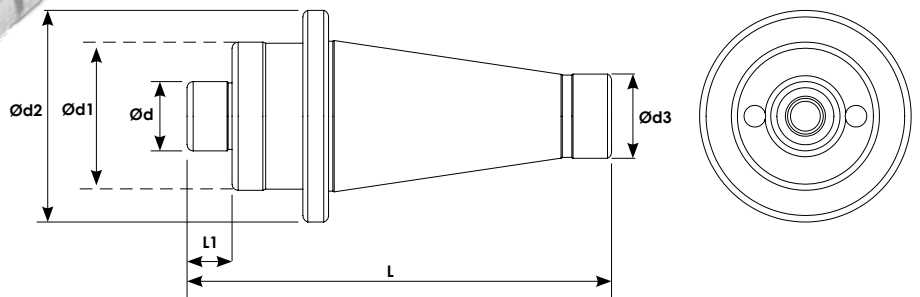

Sipariş Kodu Order Code Best.-Nr.	Stok/Stock/Lager	Ürün Kodu Product Code Produkt-Code	ŞAFT Shank Schaft	Ölçüler (mm) Dimensions (mm) Abmessungen (mm)					
				d	d1	d2	d3	L	L1
M216	●	ISO 50-22	ISO 50	22	98	52	39	196	19
M218	●	ISO 50-27	ISO 50	27	98	61	39	196	21
M220	●	ISO 50-32	ISO 50	32	98	68	39	196	24
M222	●	ISO 50-40	ISO 50	40	98	98	39	196	27
M224	●	ISO 50-60	ISO 50	60	108	108	39	196	26

MK 4 VİDALI

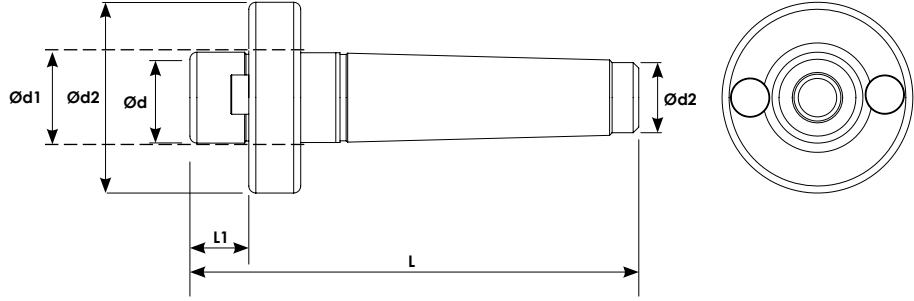

Sipariş Kodu Order Code Best.-Nr.	Stok/Stock/Lager	Ürün Kodu Product Code Produkt-Code	ŞAFT Shank Schaft	Ölçüler (mm) Dimensions(mm) Abmessungen (mm)					
				d	d1	d2	d3	L	L1
M242	●	MK 4-16	MK 4	16	43	49	25	160	17
M244	●	MK 4-22	MK 4	22	43	49	25	160	19
M246	●	MK 4-27	MK 4	27	43	58	25	160	21
M248	●	MK 4-32	MK 4	32	43	68	25	160	24



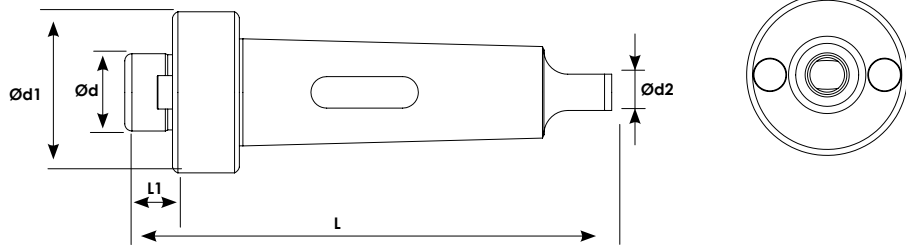

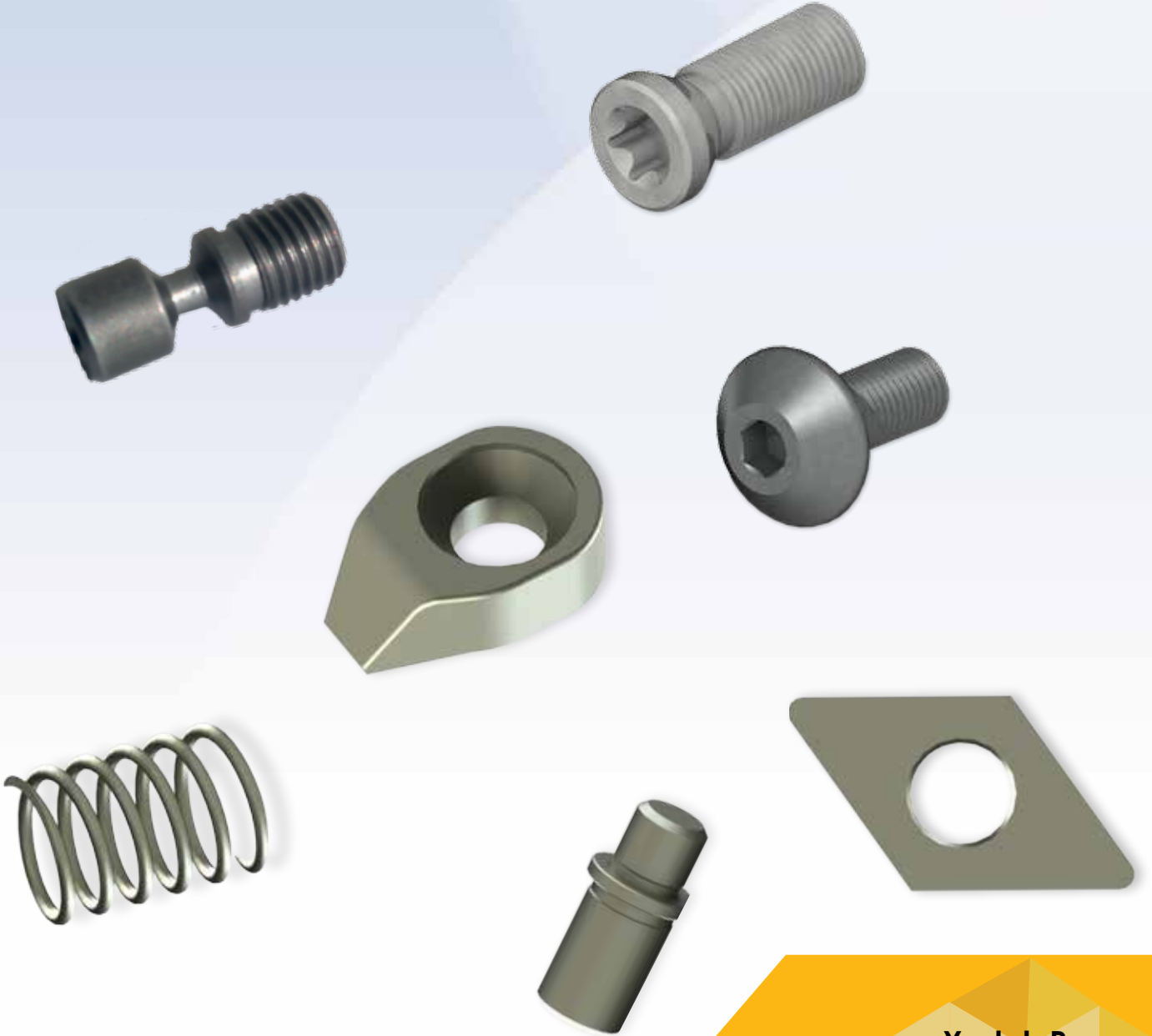

MK 5 KAMALI



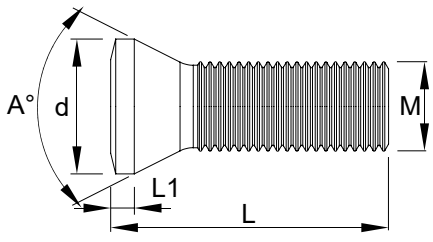

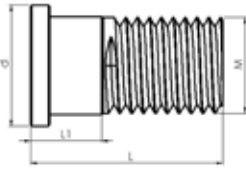

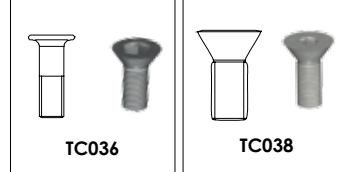



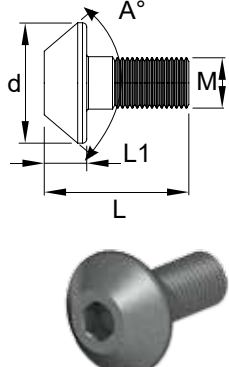
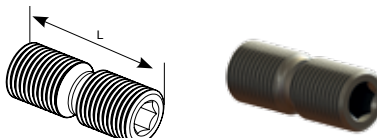
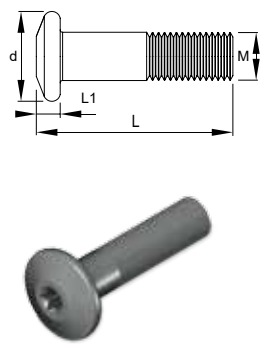
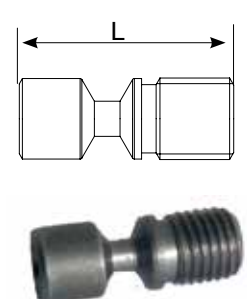
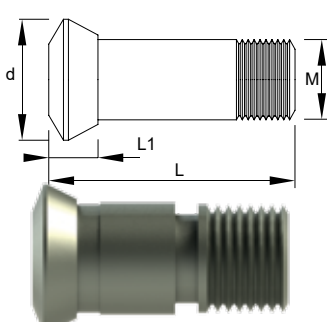



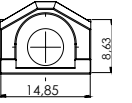

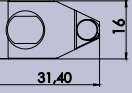

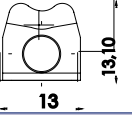

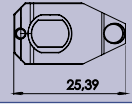

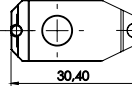

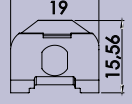

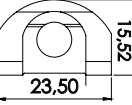

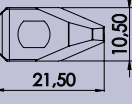

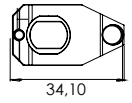

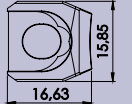
Sipariş Kodu Order Code Best.-Nr.	Stok/Stock/Lager	Ürün Kodu Product Code Produkt-Code	ŞAFT Shank Schaft	Ölçüler (mm) Dimensions(mm) Abmessungen (mm)				
				d	d2	d3	L	L1
M234	●	MK 5-22	MK 5	22	54	15	204	19
M236	●	MK 5-32	MK 5	32	68	15	204	24
M238	●	MK 5-40	MK 5	40	98	15	204	27
M240	●	MK 5-60	MK 5	60	105	15	204	26

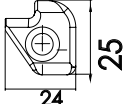

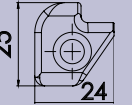

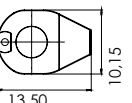

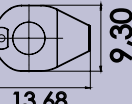

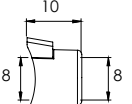

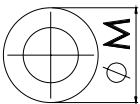



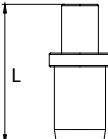

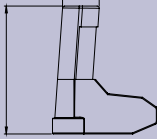





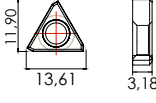

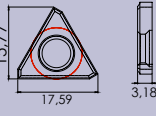

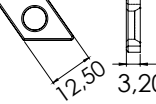

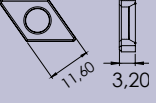

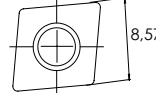

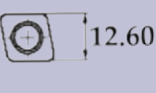
Yedek Parça
Spare Parts
Zubehör

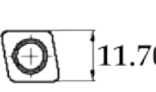

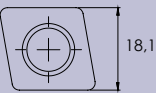

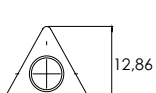





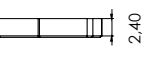



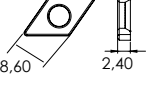

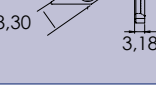

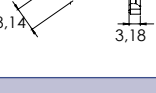

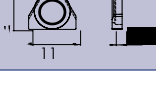



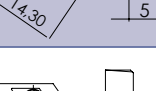

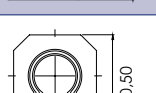

Parça/Part/Zubehör	Kod Code	M	A	d	L	Anahtar/Key Schlüssel
<p>Tork Cıvatası (Sıkma Cıvata) Torx Screw Torx Schrauben</p>  	TC058	M2	37°	2,7	4,2	T6
	TC059	M2,2	55°	3,2	5	T7
	TC060	M2,5	60°	3,5	5,5	T8
	TC063	M2,5	60°	3,5	7	T8
	TC064	M3	40°	3,8	6,5	T8
	TC065	M3	60°	4,2	7	T8
	TC066	M3	40°	4,2	11	T8
	TC067	M3,5	60°	5,3	9	T15
	TC067-1	M3,5	60°	5,3	8,5	T15
	TC068	M3,5	60°	5,3	11	T15
	TC069	M3,5	60°	4,8	8,5	T10
	TC070	M3,5	60°	4,8	11	T10
	TC073	M4	60°	5,5	7	T15
	TC074	M4	60°	5,5	10	T15
	TC075	M4	50°	6,1	11	T15
	TC076	M4	60°	5,5	12,5	T15
	TC078	M4	52°	6,5	11	T15
	TC079	M4	38°	5,1	10	T15
	TC080	M4,5	45°	6,2	11	T15
	TC083	M5	50°	7	12	T20
TC084	M5	60°	6,5	13	T20	
TC085	M5	75°	6,6	12	T20	
<p>Bükse Cıvata Shim Screw Inbuss-Schlüssel</p>  	TC048	M5		6,3	10	4 Allen
	TC049	M5			7	3,5 Allen
<p>Allık Cıvatalar Shim Screw Inbuss-Schlüssel</p>  	TC036	M3		5,6	10	T10
	TC038	M4	45°	7,30	10	T15
	TC039	M6	60°	10,6	12	4 Allen
	TC040	M3,5		8	10	T15
	TC062	M3		5,5	6,7	T10
	TC095	M5	60°	9,5	12	3 Allen

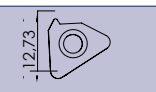
Parça/Part/Zubehör	Kod Code	M	A	d	L	Anahtar/Key Schlüssel
Baski Civatalar Locking Screw Verriegelungsschraub 	TC050	M6	70°	11,2	14	3 Allen
	TC052	M6	80°	14	17	4 Allen
	TC054	M8	80°	17,1	24	5 Allen
	TC056	M8 (sol-left)	80°	17,1	24	5 Allen
Baski Civata Locking Screw Verriegelungsschraub 	TC300	M8			21	4 Allen
Baski Civata Locking Screw Verriegelungsschraub 	TC044	M6		11	27	4 Allen
	TC046	M5		10	26	3 Allen
	TC040	M3,5		8	10	T15
Baski Civata Locking Screw Verriegelungsschraub 	TH821	M8			21	3 Allen
	TH822	M8			22	2,5 Allen
	TH613	M6			13,4	2,5 Allen
	TH617	M6			17	2 Allen
	TH512	M5			12	2 Allen
	TH-825	M8			25	3 Allen
Küre Civatalar Screws For Radius Cutter 	TC170	M3		4,2	7	T8
	TC172	M4		5,8	9	T15
	TC174	M5		7	10	T20
	TC176	M5		7,3	12	T20
	TC178	M5		7,8	16	3 Allen
	TC181	M6		9,5	22	3 Allen
	TC184	M8		13	25	4 Allen

Kod Code	Tipi Type	Parça Part	Ölçüler (mm) Dimensions(mm) Abmessungen (mm)
			M
BK017	DNMG 11		
BK018	CNMG 16		
BK019	WNMG 06		
BK020	DNMG 15 CNMG 12 SNMG 12		
BK021	VNMG 16		
BK022	TNMG 16		
BK023	TNMG 22		
BK024	DNMG 11 (Small)		
BK025	CNMG 19		
BK026	WNMG 08		
BK028	KNUX Sağ/Right		
BK030	KNUX/Left		
BK035	RDMT 16		
BK036	TPKN16		
BK300	OFCR 07		

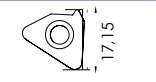
Kod Code	Tipi Type	Parça Part	Ölçüler (mm) Dimensions(mm) Abmessungen (mm)		
			M		
BSP010	Baskı Pulu				
BSP030	Baskı Pulu (Normal)				
BSP031	Baskı Pulu				
BSP032	Baskı Pulu				
BY040	M6				
BY041	M5				
BY042	M6				
BY043	M5				
BY044					
BSP020	TNMG 16 L10-D6				
BSP021	TNMG 22 L15-D7				
BSP024	TNMG 08				
BSP026	TNMG 06				
TL3	L12,2-D3,5				
TL3B	L10-D3				
TL4	L13-D4,5				
TL4A	L10,5-D4,7				
TL4B	L15,6-D5				
TS-3	D6,65-L5,5				
TS-4	D7,71-L7				

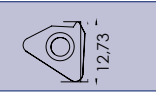
Kod Code	Tipi Type	Parça Part	Ölçüler (mm) Dimensions (mm) Abmessungen (mm)
			M
TA010	TPKN 16 ALTLIK		
TA012	TPKN 22 ALTLIK		
TA014	DNMG 15 ALTLIK		
TA014-1	DNMG 15 ALTLIK		
TA015	CCMT 09 ALTLIK		
TA016	CNMG 12 ALTLIK		
TA016-1	CNMG 12 ALTLIK		
TA017	CNMG 19 ALTLIK		
TA019	TNMG 16 ALTLIK		
TA020	WNMG 08 ALTLIK		
TA020-1	WNMG 08 ALTLIK		

Kod Code	Tipi Type	Parça Part	Ölçüler (mm) Dimensions (mm) Abmessungen (mm)
			M
TA021	WNMG 06 ALTLIK		
TA022	CNMG 16 ALTLIK		
TA030	DCMT 11 ALTLIK		
TA032	VCMT 16 ALTLIK		
TA034	VBMT 16 ALTLIK		
TA040	ER 16 ALTLIK		
TA045	TNMG 22 ALTLIK		
TA046	KNUX RIGHT ALTLIK		
TA048	KNUX LEFT ALTLIK		
TA050	SNMG ALTLIK		
TA052	SEET 12 ALTLIK		
TA061	16 ER ALTLIK		
TA062	22 ER ALTLIK		
TA060	16 IR ALTLIK		
TA063	22 IR ALTLIK		

ÇAPLAR VE Vc HIZINA GÖRE KULLANILAN DEVİRLER n(dev./dk)
Diameter and Vc delivery / Durchmesser und die Vc Zustellung

ÇAPLAR
Bore diameter / Durchmesser

VC HIZI m/dk	10	12	14	16	18	20	22	24	26	28	30	32	34	36	38	40	42	44	46	48	50	63	80	100
50	1606	1327	1137	995	885	796	724	663	612	569	531	498	468	442	419	398	379	362	346	332	318	253	199	159
60	1927	1592	1365	1194	1062	955	869	796	735	682	637	597	562	531	503	478	455	434	415	398	382	303	239	191
70	2248	1858	1592	1393	1238	1115	1013	929	857	796	743	697	656	619	587	557	531	507	485	464	446	354	279	223
80	2569	2123	1820	1592	1415	1274	1158	1062	980	910	849	796	749	708	670	637	607	579	554	531	510	404	318	255
90	2890	2389	2047	1791	1592	1433	1303	1194	1102	1024	955	896	853	796	754	717	682	651	623	597	573	455	358	287
100	3211	2654	2275	1990	1769	1592	1448	1327	1225	1137	1062	995	937	885	838	796	758	724	692	663	637	506	398	318
110	3532	2919	2502	2189	1946	1752	1592	1460	1347	1251	1168	1095	1030	973	922	876	834	796	762	730	700	556	438	350
120	3854	3185	2730	2389	2123	1910	1737	1592	1470	1365	1274	1194	1124	1062	1006	955	910	869	831	796	764	607	478	382
130	4175	3450	2957	2588	2300	2070	1882	1725	1592	1479	1380	1294	1218	1150	1090	1035	986	941	900	863	828	657	518	414
140	4496	3715	3185	2787	2477	2229	2027	1858	1715	1592	1486	1393	1311	1238	1173	1115	1062	1013	969	929	892	708	557	446
150	4817	3981	3412	2986	2654	2389	2171	1990	1837	1706	1592	1493	1405	1327	1257	1194	1137	1086	1038	995	955	758	597	478
160	5138	4246	3640	3185	2831	2548	2316	2143	1960	1820	1699	1592	1499	1415	1341	1274	1213	1158	1108	1062	1019	809	637	510
170	5459	4512	3867	3384	3008	2707	2461	2256	2082	1934	1805	1692	1592	1504	1425	1354	1289	1230	1177	1128	1083	859	677	541
180	5780	4777	4095	3583	3185	2866	2606	2389	2205	2047	1911	1791	1686	1592	1509	1433	1365	1303	1246	1194	1146	910	717	573
190	6101	5042	4322	3782	3362	3025	2750	2521	2327	2161	2017	1891	1780	1681	1592	1513	1441	1375	1315	1261	1210	960	756	605
200	6423	5308	4550	3981	3539	3185	2895	2654	2450	2275	2123	1990	1873	1769	1676	1592	1517	1448	1385	1327	1274	1011	796	637
210	6744	5573	4777	4180	3715	3344	3040	2787	2572	2389	2229	2090	1967	1858	1760	1672	1592	1520	1454	1393	1138	1062	836	669
220	7065	5839	5005	4379	3892	3503	3185	2919	2695	2502	2335	2189	2061	1946	1844	1752	1668	1592	1523	1460	1401	1112	876	701
230	7386	6104	5232	4578	4069	3662	3329	3052	2817	2616	2442	2289	2154	2035	1928	1831	1744	1665	1592	1526	1465	1163	916	732
240	7707	6369	5460	4777	4246	3822	3474	3185	2940	2730	2548	2389	2248	2123	2011	1911	1820	1737	1662	1592	1529	1213	955	764
250	8028	6635	5687	4976	4423	3981	3619	3317	3062	2843	2654	2488	2342	2212	2095	1990	1896	1809	1731	1659	1592	1264	995	1592

TORNALAMA İÇİN FORMÜLLER

Formulas for turning / Formeln für Drehen

$$\text{DEVİR SAYISI} = n = \frac{V_c \times 1000}{\pi \times D} \text{ devir / dakika}$$

Revolutions / Umdrehungen Umdrehungen / min.

n : Devir Sayısı (dev./dak.)
Revolutions / Umdrehungen Revs / min. Umdrehungen / min.

n : Devir Sayısı (dev./dak.)
Cutting Speed / Schnittgeschwindigkeit (Meter / min.)

$$\text{KESME HIZI} = V_c = \frac{\pi \times D \times n}{1000} \text{ metre / dakika}$$

Cutting speed meter / min. Schnittgeschwindigkeit

D : İş Parçasının Çapı (mm)
Workpiece diameter / Werkstückdurchmesser

π : Sabit Sayı (3,14)
Constant (3,14) / Gleich bleibend (3,14)

TORNALAMADA İŞLEME ZAMANININ HESAPLANMASI

Formulas for turning time / Formeln für Drehen Zeiten

$$\text{Çap Tornalamada} = t_h = \frac{L \times P_s}{n \times f} \text{ dakika}$$

Turning diameter minute Drehdurchmesser

Ps : Paso Sayısı (kaç defa'da)
no of passes / Durchgänge

th : İşleme Zamanı (dakika)
Processing Time / Bearbeitungszeit (min)

f : İlerleme (mm)
Length delivery / Stirn Zustellung (mm)

$$\text{Alın Tornalama} = t_h = \frac{d \times \pi}{V_c \times 1000} \times L \times P_s \text{ dakika}$$

Length turning / Stirn Drehen minute

Alın Tornalama
İçin Boy $L = \frac{d_1 - d_2}{2} \text{ mm}$

Length head turning / Länge für Stirn Drehen

Dolu Malzemedede
Alın Tornalama
Solid Stock front turning / Massive Werkstücke Stirn Drehen $L = -\frac{d}{2} \text{ mm}$

YÜZEY FREZELEMEDE KULLANILAN FORMÜLLER

Cutting Recommendations for Milling / Schnitt - Empfehlungen zum Fräsen

$$\text{DEVİR SAYISI} = n = \frac{V_c \times 1000}{\pi \times D} \text{ devir / dakika}$$

Revolutions / Umdrehungen Umdrehungen / min.

z : Frezenin Ağız Sayısı (adet)
Number of tooth / Anzahl Schneiden

k : Disk Frezenin Etkin Ağız sayısı (adet)
Effective edge of the cutter / Effektive Schneiden des Fräasers

$$\text{KESME HIZI} = V_c = \frac{\pi \times D \times n}{1000} \text{ metre / dakika}$$

Cutting speed meter / min. Schnittgeschwindigkeit

fz : Ağız Başına İlerleme (mm/ağız)
Delivery per cutting mm/Z / Zustellung pro Schneide mm/Z

th : İşleme Zamanı (dak.)
Processing time / Bearbeitungszeit minute

$$\text{TABLA İLERLEMESİ} = V_f = n \times z \times f_z \text{ mm / dak}$$

Delivery / Zustellung mm / min.

th : İşleme Zamanı (dak.)
Processing time / Bearbeitungszeit minute

HASSAS DELİK İŞLEME BARALARI İÇİN

Cutting Data for finis Boring tools / Schnittdaten für Fein Ausdrehwerkzeuge

	Malzeme / Material	HB	Vc	D 9-14	D 14-24	D 22-32	D 28-44	D 36-56	D 50-82	D 80-130
ÇELİKLER Stahl / Stahl P	Karbonsuz Low carbon Steel / C-Stahl	80-125	120-180	0.04-0.08	0.05-0.10	0.06-0.11	0.05-0.13	0.05-0.15	0.06-0.15	0.08-0.20
	Düşük Karbonlu Low carbon Steel / C-Stahl	180-280	120-170	0.03-0.08	0.05-0.08	0.06-0.10	0.06-0.13	0.06-0.15	0.08-0.15	0.10-0.20
	Düşük Alaşımli Low alloy Steel / Niderig legiettre Stahl	140-275	120-160	0.02-0.08	0.04-0.08	0.05-0.10	0.08-0.13	0.08-0.15	0.08-0.15	0.10-0.15
	Yüksek Alaşım High alloy Steel / Hoch legiettre Stahl	220-325	130-160	0.02-0.08	0.03-0.08	0.05-0.10	0.06-0.13	0.06-0.5	0.06-0.15	0.10-0.15
	Paslanmaz Austenite / Niro autenitisch (rostfrei)	135-275	110-150	0.03-0.04	0.04-0.07	0.04-0.07	0.05-0.10	0.05-0.13	0.05-0.15	0.10-0.15
	Döküm Grey cast iron / Grauguss	150-260	90-180	0.03-0.08	0.04-0.06	0.04-0.10	0.08-0.12	0.08-0.15	0.10-0.15	0.10-0.15
	Alüminyum Aluminium	30-150	130-230	0.03-0.10	0.05-0.10	0.05-0.13	0.07-0.15	0.07-0.15	0.10-0.15	0.10-0.15

KABA DELİK İŞLEME BARALARI İÇİN

Cutting Data for Boring tools for rough machining / Schnittdaten für Universal Ausbohröpfe

	Malzeme / Material	HB	Vc	D 9-14	D 14-24	D 22-32	D 28-44	D 36-56	D 50-82	D 80-130
ÇELİKLER Stahl / Stahl P	Karbonsuz Low carbon Steel / C-Stahl	80-125	120-180	0.05-0.10	0.05-0.12	0.10-0.15	0.10-0.20	0.10-0.22	0.10-0.25	0.10-0.25
	Düşük Karbonlu Low carbon Steel / C-Stahl	180-280	120-160	0.05-0.10	0.05-0.12	0.10-0.15	0.10-0.20	0.10-0.22	0.10-0.25	0.10-0.25
	Düşük Alaşımli Low alloy Steel / Niderig legiettre Stahl	140-275	120-160	0.05-0.10	0.05-0.10	0.10-0.15	0.10-0.20	0.10-0.22	0.10-0.25	0.10-0.25
	Yüksek Alaşım High alloy Steel / Hoch legiettre Stahl	220-325	130-160	0.05-0.10	0.05-0.10	0.10-0.20	0.10-0.20	0.10-0.20	0.10-0.25	0.10-0.25
	Paslanmaz Austenite / Niro autenitisch (rostfrei)	135-275	110-150	0.05-0.10	0.07-0.10	0.08-0.12	0.10-0.20	0.10-0.20	0.10-0.25	0.10-0.25
	Döküm Grey cast iron / Grauguss	150-260	90-180	0.08-0.10	0.084-0.10	0.10-0.20	0.10-0.20	0.10-0.25	0.10-0.25	0.10-0.25
	Alüminyum Aluminium	30-150	150-220	0.08-0.12	0.10-0.15	0.10-0.15	0.10-0.20	0.10-0.25	0.10-0.25	0.10-0.25

3D U-DRILL' LER İÇİN

Cutting Data for 3XD Insert Drills / Schnittdaten für 3xD Vollbohrer

	Malzeme / Material	HB	Vc	D 13-15	D 16-24	D 25-32	D 33-40	D 41-56	
ÇELİKLER Stahl / Stahl P	Karbonsuz Low carbon Steel / C-Stahl	<0.15%C 0.15-0.45%C	80-170	120-220	0.04-0.08	0.05-0.10	0.05-0.10	0.04-0.10	0.08-0.12
	Düşük Karbonlu Low carbon Steel / C-Stahl	>=0.45%C	180-280	80-180	0.04-0.08	0.04-0.10	0.05-0.12	0.08-0.15	0.10-0.20
	Düşük Alaşımli Low alloy Steel / Niderig legiettre Stahl		140-275	70-150	0.04-0.10	0.06-0.13	0.01-0.18	0.11-0.20	0.13-0.25
	Yüksek Alaşım High alloy Steel / Hoch legiettre Stahl		220-325	30-150	0.04-0.08	0.04-0.10	0.06-0.12	0.08-0.14	0.10-0.18
	Paslanmaz Austenite / Niro autenitisch (rostfrei)		135-275	50-130	0.04-0.08	0.04-0.10	0.06-0.12	0.08-0.14	0.10-0.18
			135-275	60-150	0.04-0.08	0.04-0.12	0.06-0.14	0.08-0.18	0.12-0.20
	Döküm Grey cast iron / Grauguss		150-220	130-220	0.04-0.12	0.06-0.14	0.08-0.18	0.10-0.20	0.12-0.25
	Alüminyum Aluminium		30-150	150-280	0.04-0.12	0.06-0.14	0.08-0.16	0.10-0.20	0.12-0.25

ISO	Malzeme / Material	HB	Malzeme No.	DIN	TS	ABD AISI/SAE									
P ÇELİKLER Steel / Stahl	Alaşımsız Çelikler Low carbon Steel C-Stahl %C0,05-0,25	80 - 170	1.0116	St 37-3	St 37-3	A 573-81 65									
			1.0401	C15	C15	1015									
			1.0402	C22	C22	1020									
			1.0715	9SMn28	9SMn28	1213									
			1.0718	9SMnPb28	9SMnPb28	12L13									
			1.0722	10SPb20	10SPb20	-									
			1.0736	9SMn36	9SMn36	1215									
			1.0737	9SMnPb36	9SMnPb36	12L14									
			1.1141	Ck15	Ck15	1015									
			1.1158	Ck25	Ck25	1025									
	%C0,25-0,55	125-225	1.0501	C35	C35	1035									
			1.0503	C45	C45	1045									
			1.0726	35S20	35S20	1140									
			1.1157	40Mn4	40Mn4	1039									
			1.1167	36Mn5	36Mn5	1335									
			1.1170	28Mn6	28Mn6	1330									
			1.1191	Ck 45	Ck 45	1045									
			1.0535	C 55	C 55	1055									
			1.1203	Ck 55	Ck 55	1055									
			1.1221	Ck 60	Ck 60	1060									
	Düşük Alaşımlı Çelikler Low alloy Steel Niderig legiettre Stahl	140 - 275	1.0841	St52-3	St52-3	5120									
			1.0961	60SiCr7	60SiCr7	9262									
			1.3505	100Cr6	100Cr6	52100									
			1.6523	21NiCrMo2	21NiCrMo2	8620									
			1.6546	40NiCrMo22	40NiCrMo22	8740									
			1.7131	16MnCr5	16MnCr5	5115									
			1.6582	35CrNiMo6	35CrNiMo6	4340									
			1.7035	41Cr4	41Cr4	5140									
			1.7218	25CrMo4	25CrMo4	4130									
			1.7225	42CrMo4	42CrMo4	4140									
1.8159	50CrV4	50CrV4	6150												
	Yüksek Alaşımlı Çelikler High alloy Steel Hoch legiettre Stahl	220 - 325	1.2080	X210Cr12	X210Cr12	D3									
			1.2344	X40CrMoV51	X40CrMoV51	H13									
			1.3343	S6-5-2	S6-5-2	D3									
			1.2379	X210Cr12G	X210Cr12G	HNV3									
				Öztenitik Malzemeler Austenite	135 - 175	1.4350	X5CrNi189	X5CrNi189	304						
						1.4401	X5CrNiMo18-10	X5CrNiMo18-10	316						
						1.4845	X12CrNi25-21	X12CrNi25-21	310S						
							Feritik/Martensitik Malzemeler	135 - 275	1.4000	X7Cr13	X7Cr13	403			
									1.4005	X12CrS13	X12CrS13	416			
									1.4006	X10Cr13	X10Cr13	410			
	Gri Dökme Demirler Grey cast iron Grauguss	150 - 220							0.6015	GG15	GG15	No25B			
									0.6020	GG20	GG20	No30B			
									0.6025	GG25	GG25	No35B			
									0.6030	GG30	GG30	No45B			
			0.6035	GG35	GG35				No50B						
				Temper Döküm Malleble cast iron Temperguss	150 - 250				0.8145	GTS45	GTS45	40010			
									0.8155	GTS50	GTS50	50005			
							Sfero Dökme Demirler Spheroidal cast iron Sphäroguss	180 - 260	0.7040	GGG40	GGG40	60-40-18			
									0.7050	GGG50	GGG50	80-85-06			
									0.7070	GGG70	GGG70	100-70-03			
	Alüminyum Alaşımları Aluminium alloy Aluminium Legierungen	30 - 150							3.0255	AL99,5	AL99,5	1000			
									3.2315	ALMgSi1	ALMgSi1	-			
										Özel Alaşımlar Special Alloys Sonder Legierungen	30 - 150	3.1325	ALMg1	ALMg1	2024
												3.3245	ALMg3Si	ALMg3Si	-

1	2	3			4
Kesici Uç Tipi Cutting Style Plattenform	Uç Açısı Clearance Angle Fräswinkel	Uç Toleransları Tolerance Toleranz			Kesici Uç Delik Tipi Type of Insert Plattentyp
		Sembol	m (+)	s (+)	d (+)
		A	0,005	0,025	0,025
		F	0,005	0,025	0,013
		C	0,013	0,025	0,025
		H	0,013	0,025	0,013
		E	0,025	0,025	0,025
		G	0,025	0,130	0,05-0,013
		J	0,005	0,025	0,05-0,013
		K	0,013	0,025	0,05-0,013
		L	0,025	0,025	0,05-0,013
M	0,08-0,18	0,130	0,05-0,013		
N	0,08-0,18	0,025	0,05-0,013		
U	0,05-0,38	0,130	0,08-0,025		











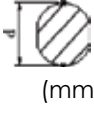

















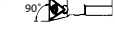





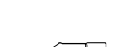

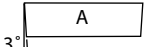
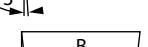
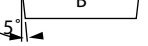
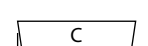

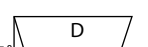
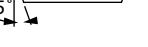
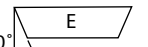

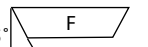

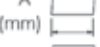
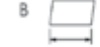











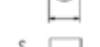













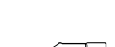



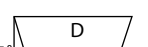
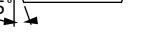
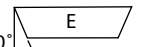

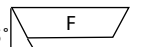

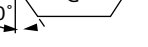

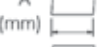
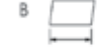











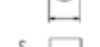









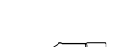
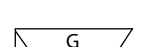
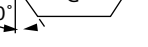
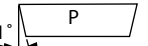
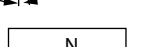
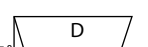
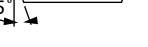
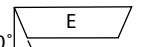

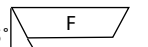

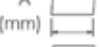













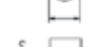

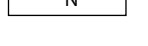

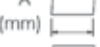
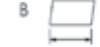
T P K N 22 04 08 F R



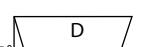
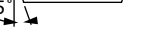
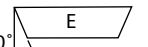

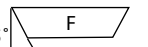



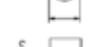

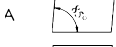
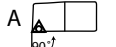
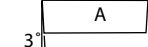

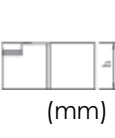
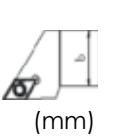
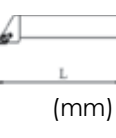

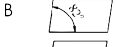
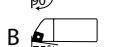



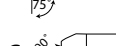
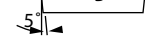



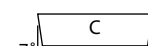







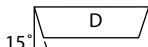

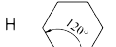
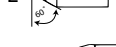
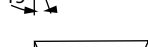

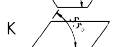
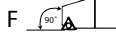
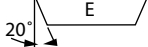

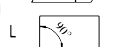



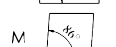

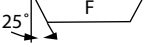



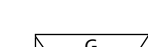

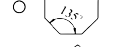
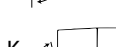
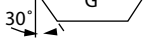



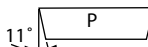

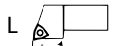
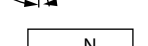

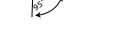
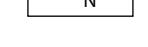

5	6	7	8																																																
Kesme Kenar Uzunluğu Length of Cutting Edge Schneiden länge	Uç Kalınlığı Height of Cutting Edge Schneidkantenhöhe	Uç Radüsü Insert Radius Planfase oder Eckenradius	Kesme Kenarı Şekli Insert Shapes WSP-FORM																																																
			Keskin Açılı Yuvarlatılmış Açılı																																																
			<table border="1"> <thead> <tr> <th>Sembol</th> <th>S</th> <th>Sembol</th> <th>m (+)</th> </tr> </thead> <tbody> <tr> <td>01</td> <td>1,59</td> <td>00</td> <td>0</td> </tr> <tr> <td>T1</td> <td>1,98</td> <td>02</td> <td>0,2</td> </tr> <tr> <td>02</td> <td>2,38</td> <td>04</td> <td>0,4</td> </tr> <tr> <td>T2</td> <td>2,58</td> <td>08</td> <td>0,8</td> </tr> <tr> <td>03</td> <td>3,18</td> <td>12</td> <td>1,2</td> </tr> <tr> <td>T3</td> <td>3,97</td> <td>16</td> <td>1,6</td> </tr> <tr> <td>04</td> <td>4,76</td> <td>24</td> <td>2,4</td> </tr> <tr> <td>05</td> <td>5,56</td> <td>32</td> <td>3,2</td> </tr> <tr> <td>06</td> <td>6,35</td> <td></td> <td></td> </tr> <tr> <td>07</td> <td>7,94</td> <td></td> <td></td> </tr> <tr> <td>09</td> <td>9,52</td> <td></td> <td></td> </tr> </tbody> </table>	Sembol	S	Sembol	m (+)	01	1,59	00	0	T1	1,98	02	0,2	02	2,38	04	0,4	T2	2,58	08	0,8	03	3,18	12	1,2	T3	3,97	16	1,6	04	4,76	24	2,4	05	5,56	32	3,2	06	6,35			07	7,94			09	9,52		
			Sembol	S	Sembol	m (+)																																													
			01	1,59	00	0																																													
			T1	1,98	02	0,2																																													
			02	2,38	04	0,4																																													
			T2	2,58	08	0,8																																													
			03	3,18	12	1,2																																													
			T3	3,97	16	1,6																																													
			04	4,76	24	2,4																																													
05	5,56	32	3,2																																																
06	6,35																																																		
07	7,94																																																		
09	9,52																																																		
			9 İlerleme Yönü Bearbeitung Spichtung Hand of Tool Sol Yön Nötr Sag Yön																																																

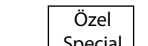
1	2	3			4
Kesici Uç Tipi Cutting Style Plattenform	Uç Açısı Insert Angle Fräswinkel	Uç Toleransları Tolerance Toleranz			Kesici Uç Delik Tipi Type of Insert Plattentyp
		Sembol	m (+)	s (+)	d (+)
		A	0,005	0,025	0,025
		F	0,005	0,025	0,013
		C	0,013	0,025	0,025
		H	0,013	0,025	0,013
		E	0,025	0,025	0,025
		G	0,025	0,130	0,05-0,013
		J	0,005	0,025	0,05-0,013
		K	0,013	0,025	0,05-0,013
		L	0,025	0,025	0,05-0,013
M	0,08-0,18	0,130	0,05-0,013		
N	0,08-0,18	0,025	0,05-0,013		
U	0,05-0,38	0,130	0,08-0,025		

D N M G 15 06 08 HR

5	6	7		8		
Kesme Kenar Uzunluğu Length of Cutting Edge Schneiden länge	Uç Kalınlığı Height of Cutting Edge Schneidkantenhöhe	Uç Radüsü Insert Radius Planfase oder Eckenradius		Kesme Kenarı Şekli Insert Shapes WSP-FORM		
				9 Uç Formları Insert Shapes WSP-Forml		
		Sembol	S		Sembol	m (+)
		01	1,59		00	0
		T1	1,98		02	0,2
		02	2,38		04	0,4
		T2	2,58		08	0,8
		03	3,18		12	1,2
		T3	3,97		16	1,6
		04	4,76		24	2,4
		05	5,56		32	3,2
06	6,35					
07	7,94					
09	9,52					

S	3 2	T	D	D	U	N	R	1 5									
1	2	3	4	5	6	7	8	9									
Takım Malzemesi Type of Shank Schaftansführung	Şaft Geniřlięi Ø Shank Ø Schaft	Takım Boyu Tool Length Werkzeuglänge	Uç Baęlama Sistemi Clamping System Klemmsystem	Kesici Uç Tipi Insert Form WSP-Form	Kater Tipi Tool Type Shank Werkzeugtyp	Uç Açısı Insert Angle WSP-Freiwinkel	Kenar Yönü Holder Execution Bearbeitungsrichtung	Uç Kenar Uzunluęu Cutting Edge WSP-Grösse									
A: Çelik Gövdeli içten Sogutmalı Coolant Through Steel Shank Mit Kühlbohrung	 (mm)	 (mm)	D  ÇEKİLMELİ	A  B  C  D  E  H  K  L  M  O  P  R  S  T  V  W 	F  L  Q  S  U  W  Z  X 	A  B  C  D  E  F  G  P  N  Özel Special O 	R  	A  B  C  D  E  K  L  M  O  P  R  S  T  V  W 									
									C: Toz Metal Gövdeli Hardmetal Shank Hartmetall Stahlkopf	06 = 6	D = 60	M  BASKI PABUÇLU	E  H  K  L  M  O  P  R  S  T  V  W 	S  U  W  Z  X 	D  E  F  G  P  N  Özel Special O 	R  	A  B  C  D  E  K  L  M  O  P  R  S  T  V  W 
										08 = 8	E = 70						
										10 = 10	F = 80						
										12 = 12	G = 90						
										14 = 14	H = 100						
										16 = 16	J = 110						
										20 = 20	K = 125						
										22 = 22	L = 140						
									25 = 25	M = 150							
32 = 32	N = 160																
40 = 40	P = 170																
50 = 50	Q = 180																
E: Toz Metal Gövdeli içten Sogutmalı Hardmetal Shank With Coolant Hole Hartmetall Schaft mit Stahlkopf und Kühlbohrung		R = 200	P  LEVYELİ	O  P  R  S  T  V  W 	X  Z  X 	G  P  N  Özel Special O 	R  	A  B  C  D  E  K  L  M  O  P  R  S  T  V  W 									
		S = 250															
		T = 300															
		U = 350															
		V = 400															
		W = 450															
		Y = 500															
		X = ÖZEL Special Sonderform															
S: Çelik Gövdeli Steel Shank Stahl Schaft			S  VIDALI	T  V  W 	X  Z 	Özel Special O 	R  	A  B  C  D  E  K  L  M  O  P  R  S  T  V  W 									

D	D	J	N	R	20	20	K	15
1	2	3	4	5	6	7	8	9
Uç Bağlama Sistemi Clamping System Klemmsystem	Kesici Uç Tipi Cutting Style Plattenform	Kater Tipi Type Werkzeugtyp	Uç Açısı Insert Angle WSP-Freiwinkel	Kater Yönü Holder Execution Bearbeitungsrichtung	Şaft Yüksekliği Height of Shank Schaftquerschnitts	Şaft Genişliği Width of Shank Schafbreite	Takım Boyu Length of Holder Werkzeuiglänge	Uç Kenar Uzunluğu Length of Cutting Edge WSP-Grösse
	A 	A 	A 		 (mm)	 (mm)	 (mm)	A (mm) 
	B 	B 	B 					B (mm) 
	C 	C 	C 					C (mm) 
	D 	D 	D 					D (mm) 
	E 	E 	E 					E (mm) 
	H 	H 	H 					H (mm) 
	K 	K 	K 					K (mm) 
	L 	L 	L 					L (mm) 
	M 	M 	M 					M (mm) 
	O 	O 	O 					O (mm) 
	P 	P 	P 					P (mm) 
	R 	R 	R 					R (mm) 
	S 	S 	S 					S (mm) 
	T 	T 	T 					T (mm) 
	V 	V 	V 					V (mm) 
W 	W 	W 	W (mm) 					
			Özel Special O				R = 200	R (mm) 
							S = 250	S (mm) 
							T = 300	T (mm) 
							U = 350	U (mm) 
							V = 400	V (mm) 
							W = 450	W (mm) 
							Y = 500	Y (mm) 
							X = ÖZEL Special Sonderform	X (mm) 